

[54] **SPICE SHAKER**
[76] **Inventor: Delbert W. Stevens, Jr., 164 W. Burton Pl., Chicago, Ill. 60610**
[**] **Term: 14 Years**
[21] **Appl. No.: 257,300**
[22] **Filed: Oct. 13, 1988**
[52] **U.S. CL. D7/591**
[58] **Field of Search D7/52-56; 222/141.1-142.9; 241/168, 169, 169.1; D9/349, 359, 362, 367**

[56] **References Cited**
PUBLICATIONS
Steel & Style: The Story of Alessi Household Ware, by Scarzella, 1985, pp. 100-103, Condiment Set.
Alessi brochure, date unknown, Pepper Mill #3072.

Gift & Art Buyer, 1/60, p. 107, Salt & Pepper Set #12.
Primary Examiner—Bernard Ansher
Assistant Examiner—Terry A. Pfeffer
Attorney, Agent, or Firm—Neuman, Williams, Anderson & Olson

[57] **CLAIM**
The ornamental design of a spice shaker, as shown and described.

DESCRIPTION
FIG. 1 is a side elevational view of a spice shaker showing my new design;
FIG. 2 is a top plan view thereof;
FIG. 3 is a top perspective view thereof;
FIG. 4 is a bottom plan view thereof;
FIG. 5 is an exploded cross-sectional view taken along line 5-5 of FIG. 1; and
FIG. 6 is a bottom perspective view thereof.

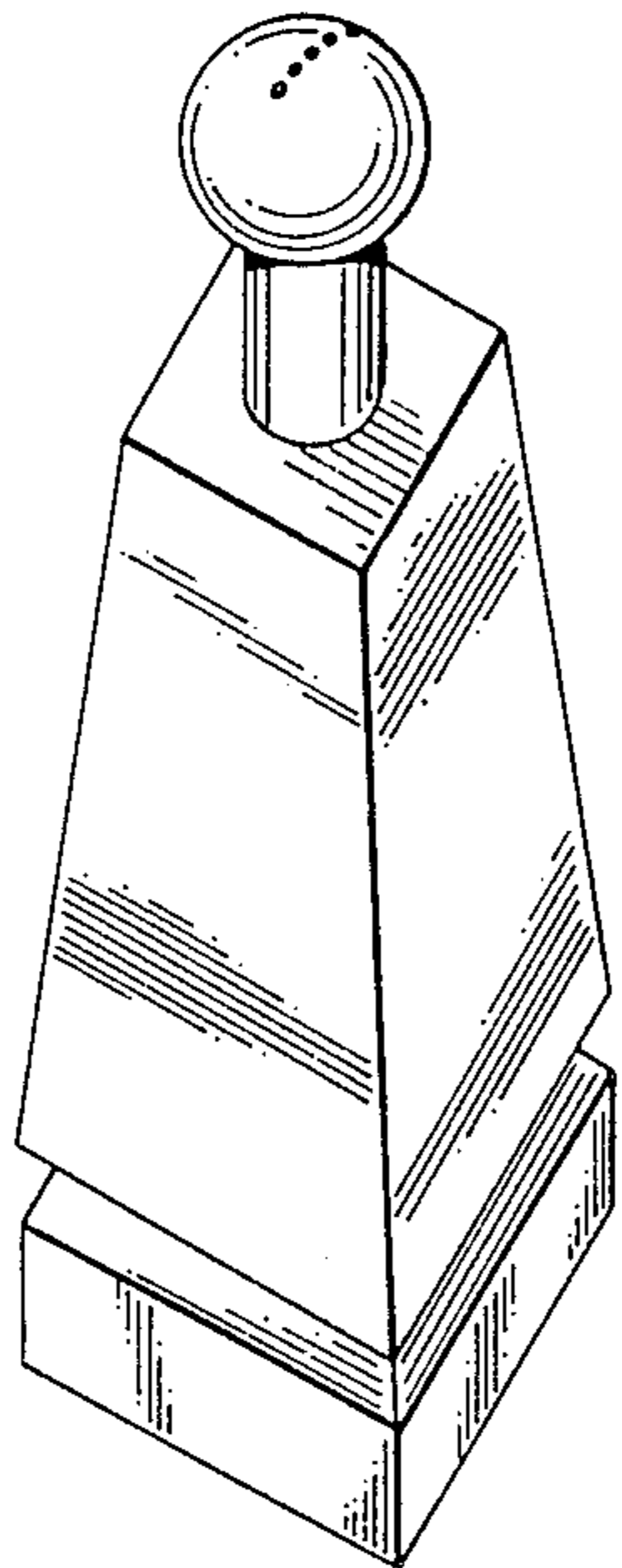

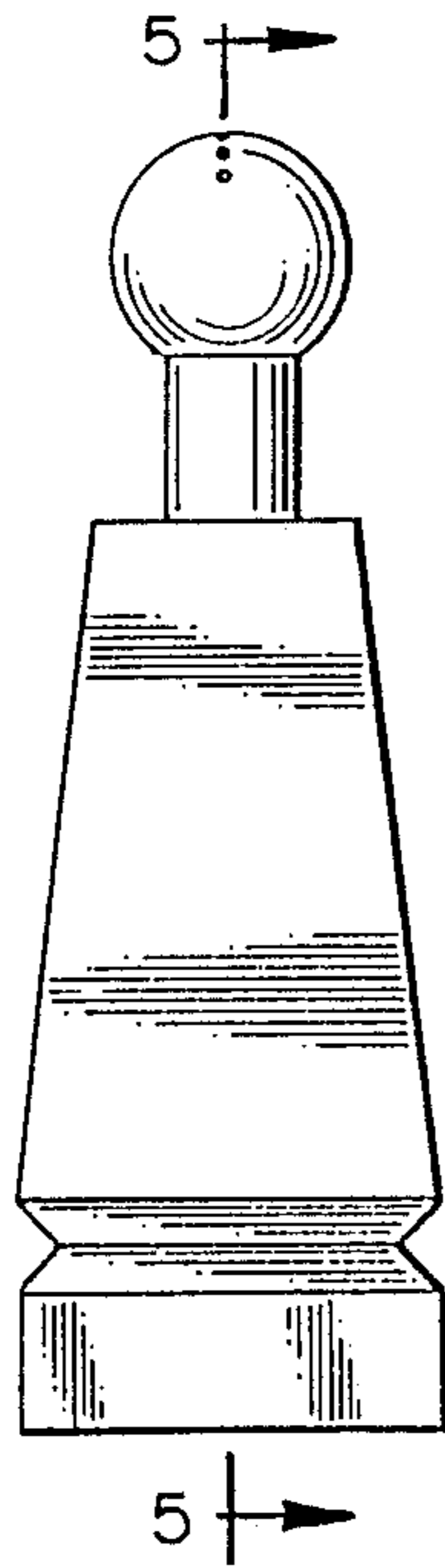

FIG. 1

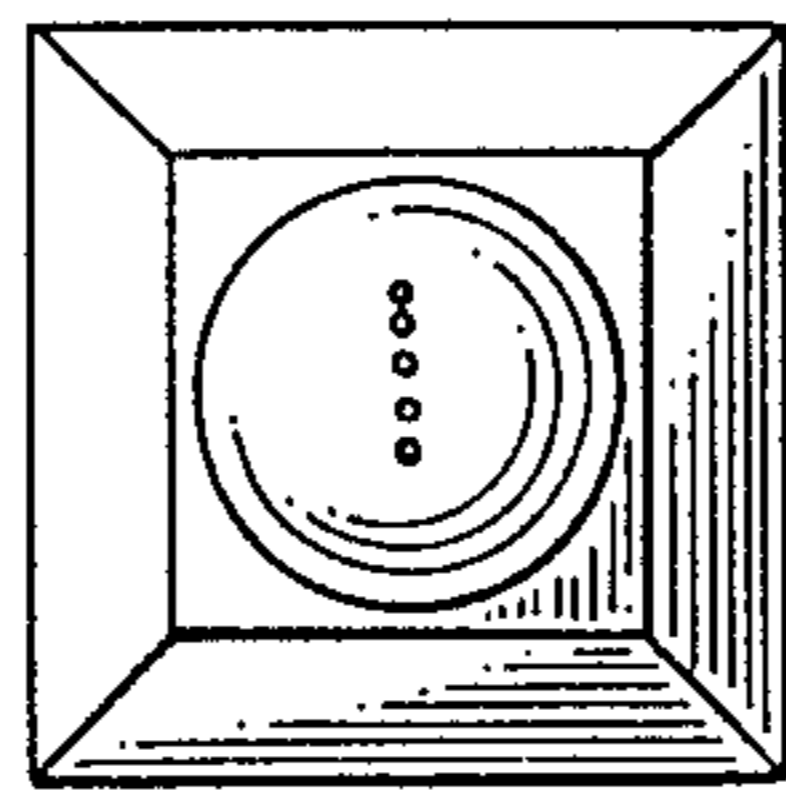

FIG. 2

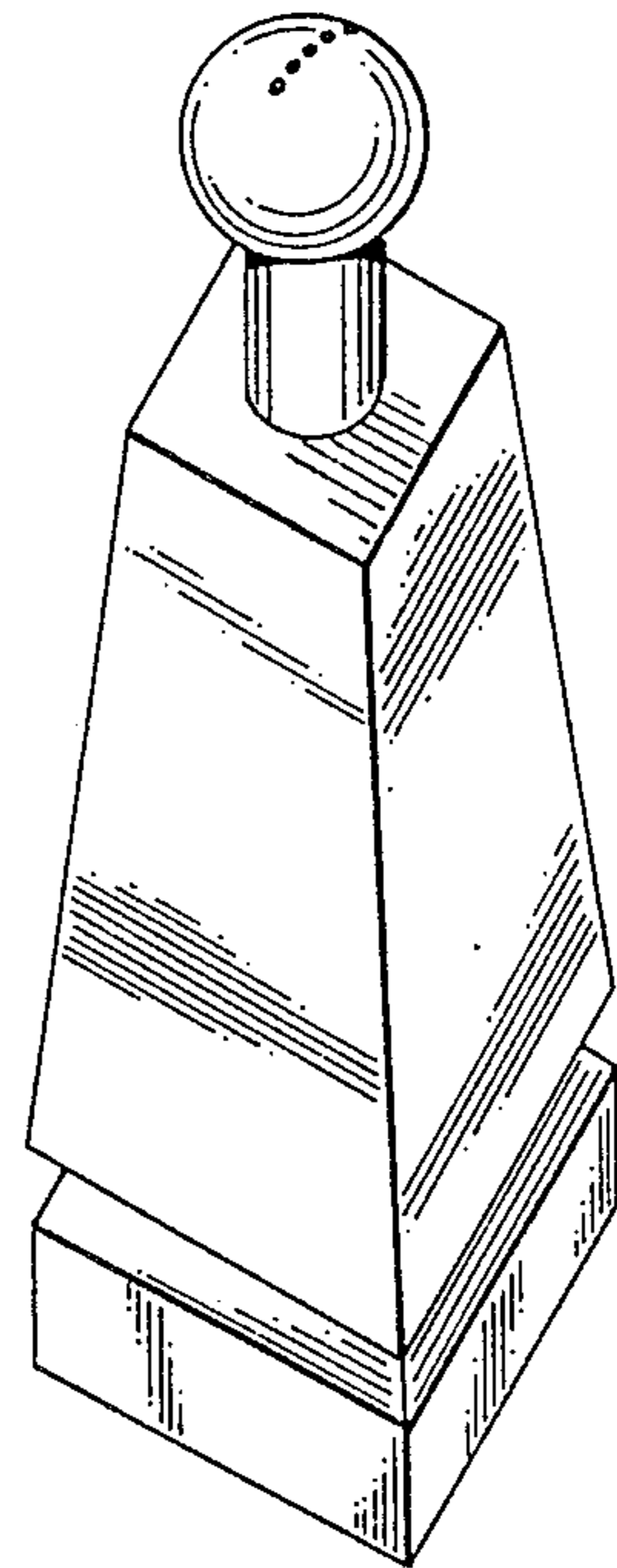

FIG. 3

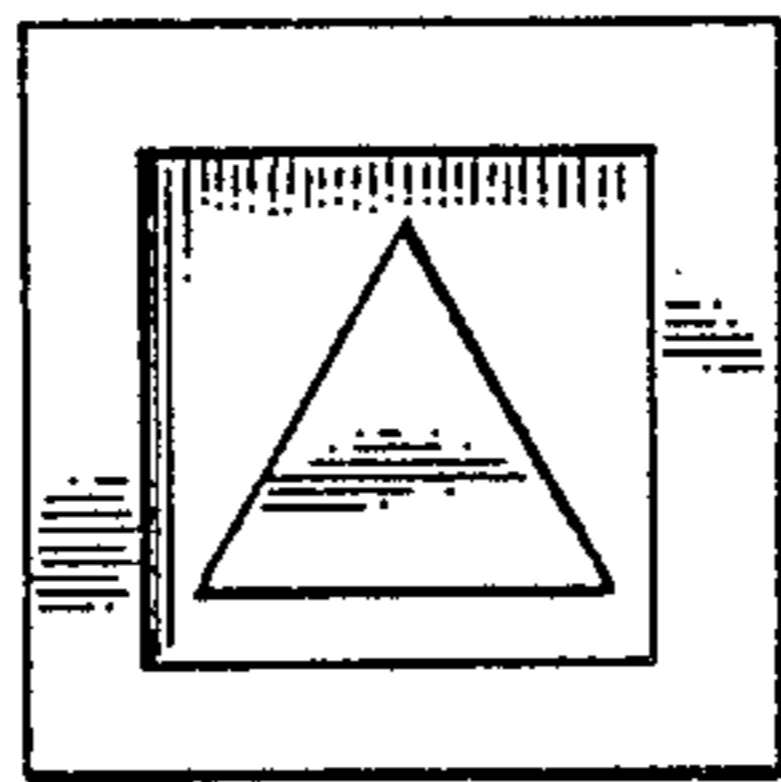

FIG. 4

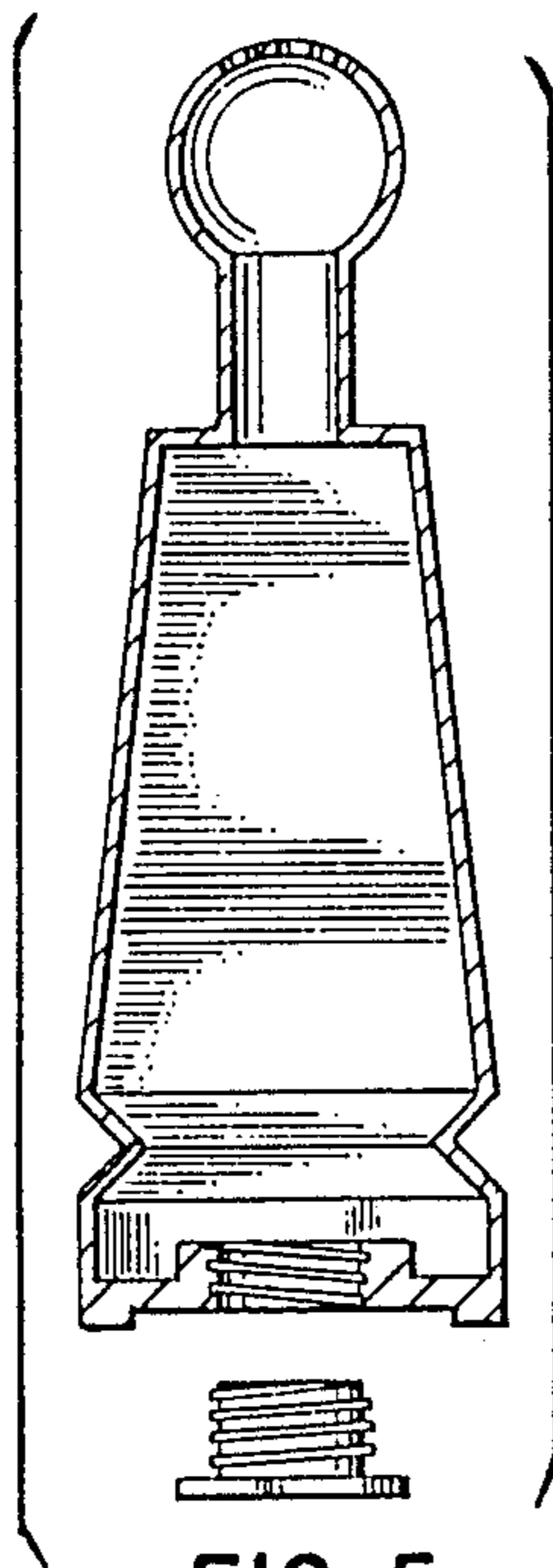

FIG. 5

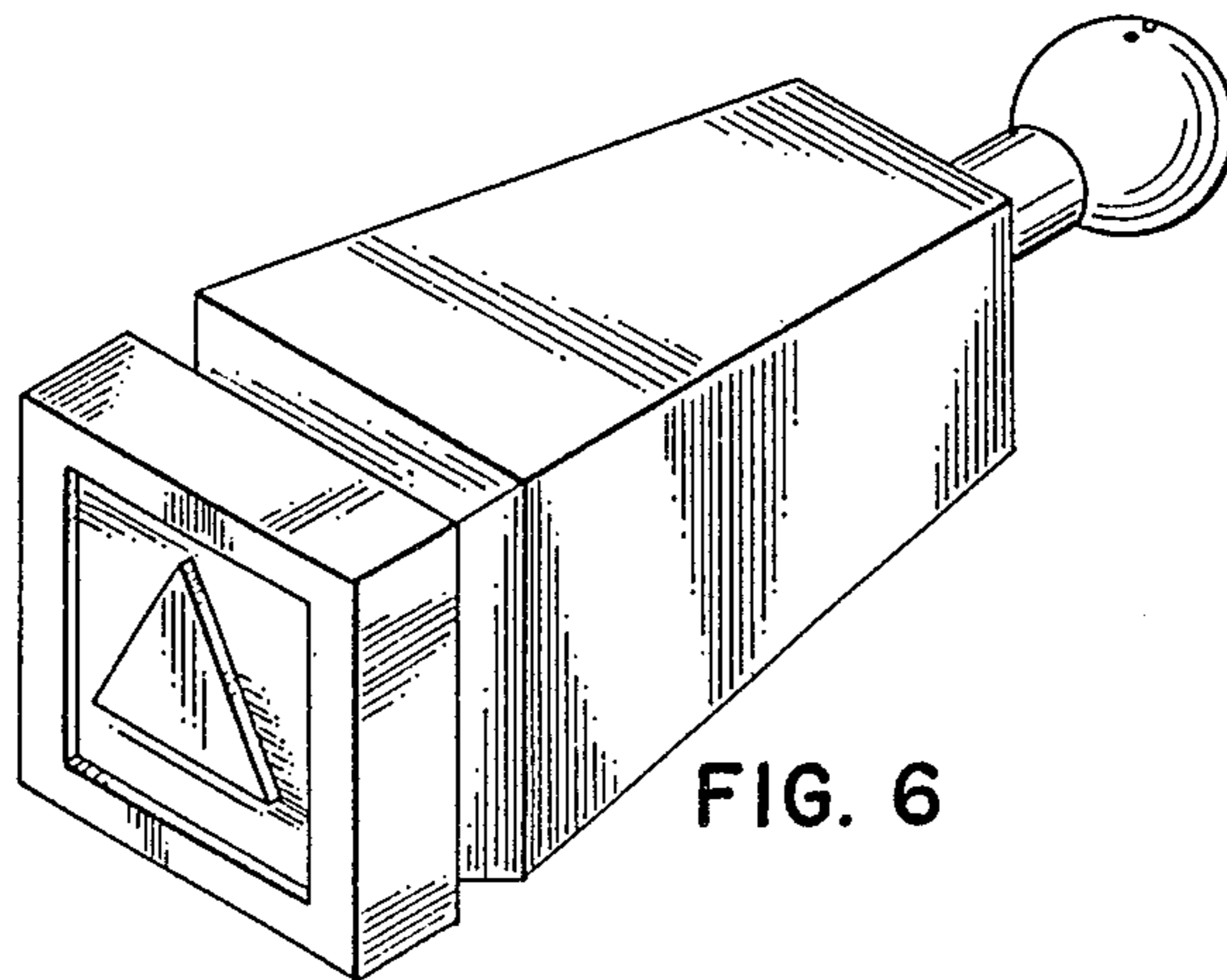

FIG. 6