

[54] PAN LID HOLDER

[76] Inventor: Lowell L. Fetty, 4603 S. Rte. 47, Woodstock, Ill. 60102

[**] Term: 14 Years

[21] Appl. No.: 110,440

[22] Filed: Oct. 20, 1987

[52] U.S. Cl. D6/462; D7/618

[58] Field of Search D6/397, 407, 408, 418, D6/419, 429, 430, 450, 458, 462-468, 485, 487; D7/618, 403; D8/380; 211/181; 248/175

[56] References Cited

U.S. PATENT DOCUMENTS

- D. 91,717 3/1934 Maguire D6/487 X
- D. 282,323 1/1986 Fetty D6/462
- D. 295,933 5/1988 Colby D6/487 X

OTHER PUBLICATIONS

Carson's of High Point, Z-shaped table at center. Interiors, 1/1966, p. 139, F. Pace Collection.

Primary Examiner—Bruce W. Dunkins
Assistant Examiner—Jeffrey Asch
Attorney, Agent, or Firm—Matthew R. P. Perrone, Jr.

[57] CLAIM

The ornamental design for a pan lid holder, as shown and described.

DESCRIPTION

FIG. 1 is a perspective view of a pan lid holder showing my new design;

FIG. 2 is a top plan view thereof;

FIG. 3 is a bottom plan view thereof;

FIG. 4 is a left side elevational view, the right side being a mirror image thereof;

FIG. 5 is a front elevational view thereof;

FIG. 6 is a rear elevational view thereof; and

FIG. 7 is a perspective view thereof, with the broken line disclosure of a pan lid being for illustrative purposes only.

Other views, construction, and arrangements of the z-shaped pan lid holder are conventional.

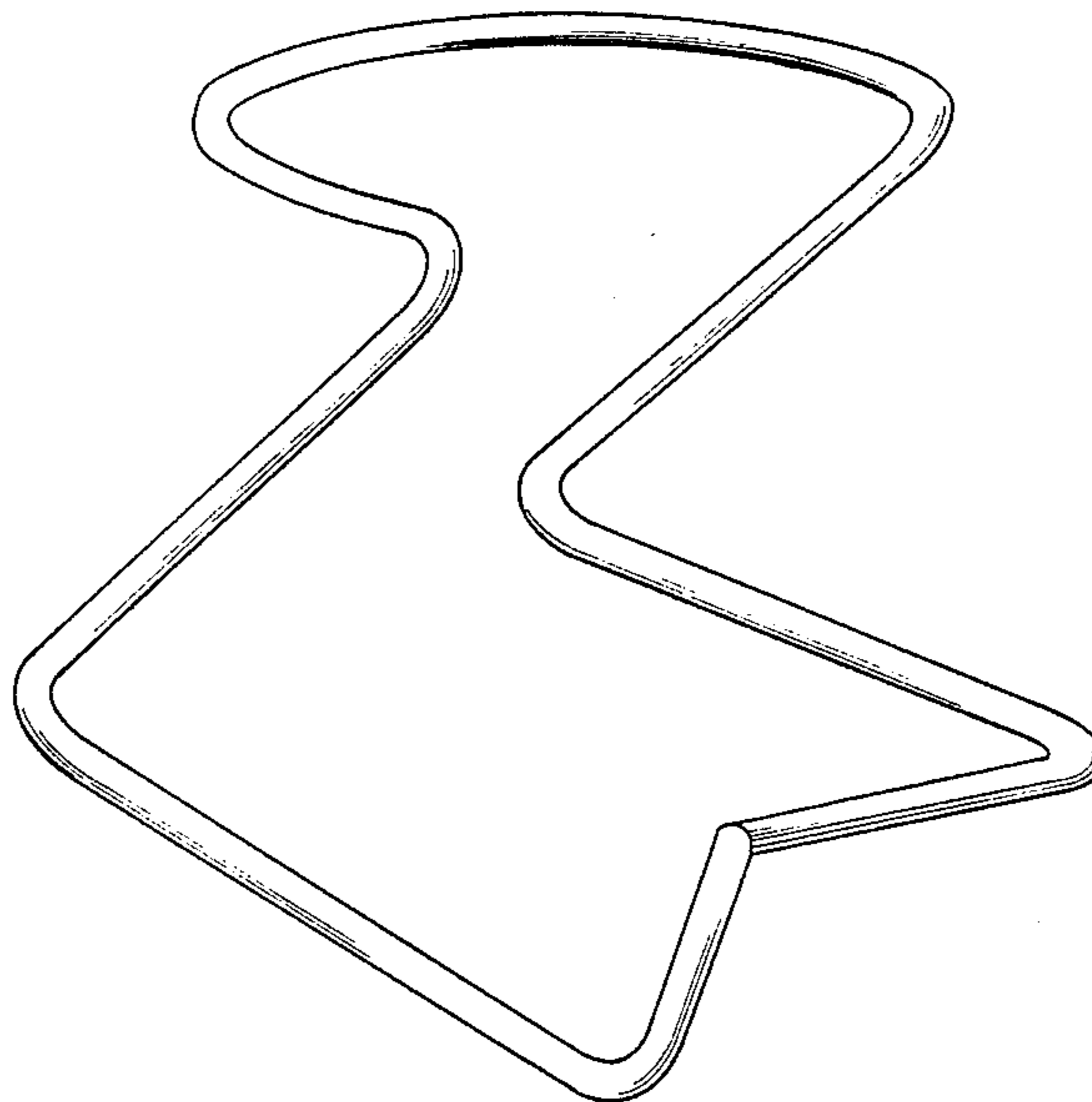

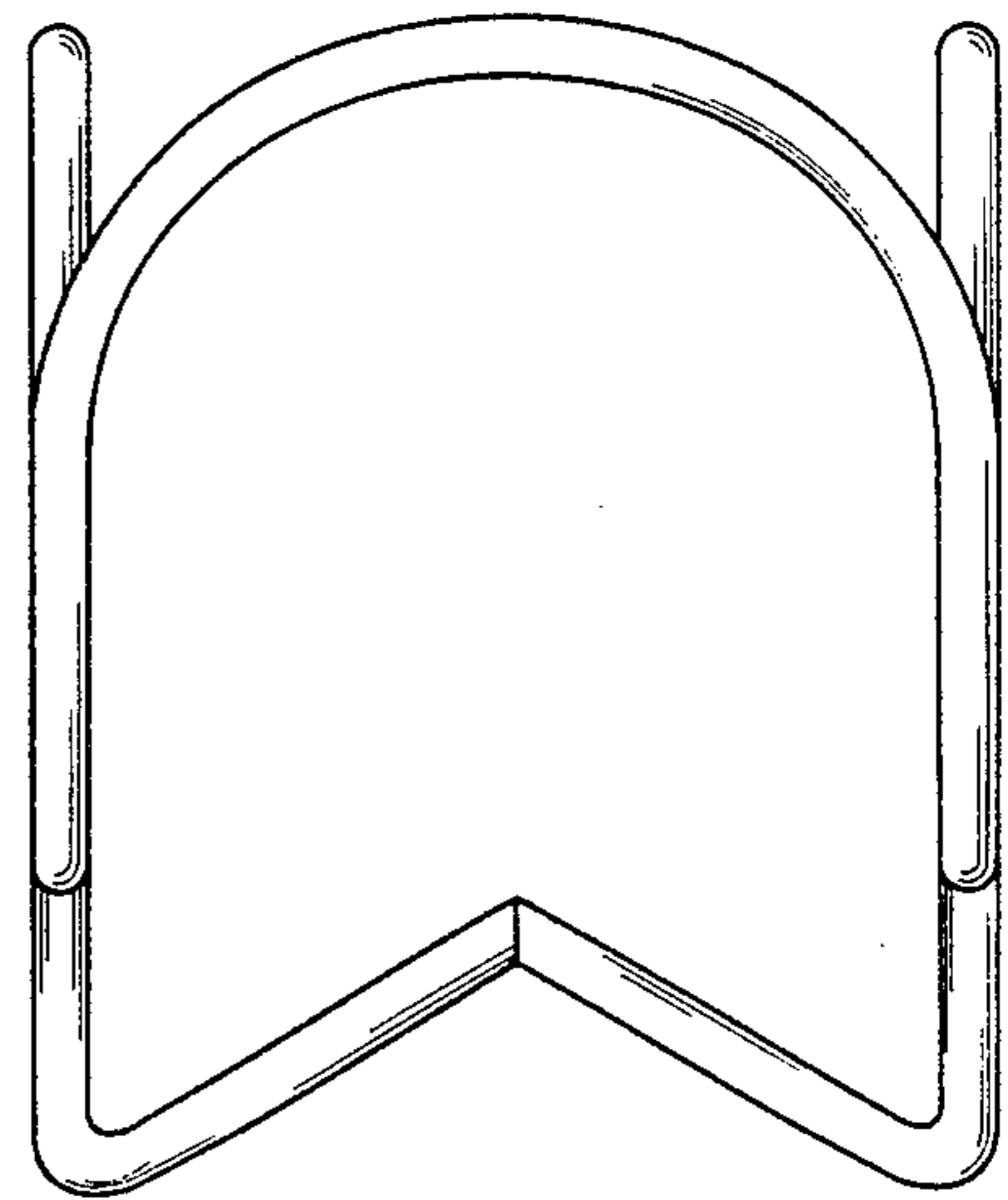
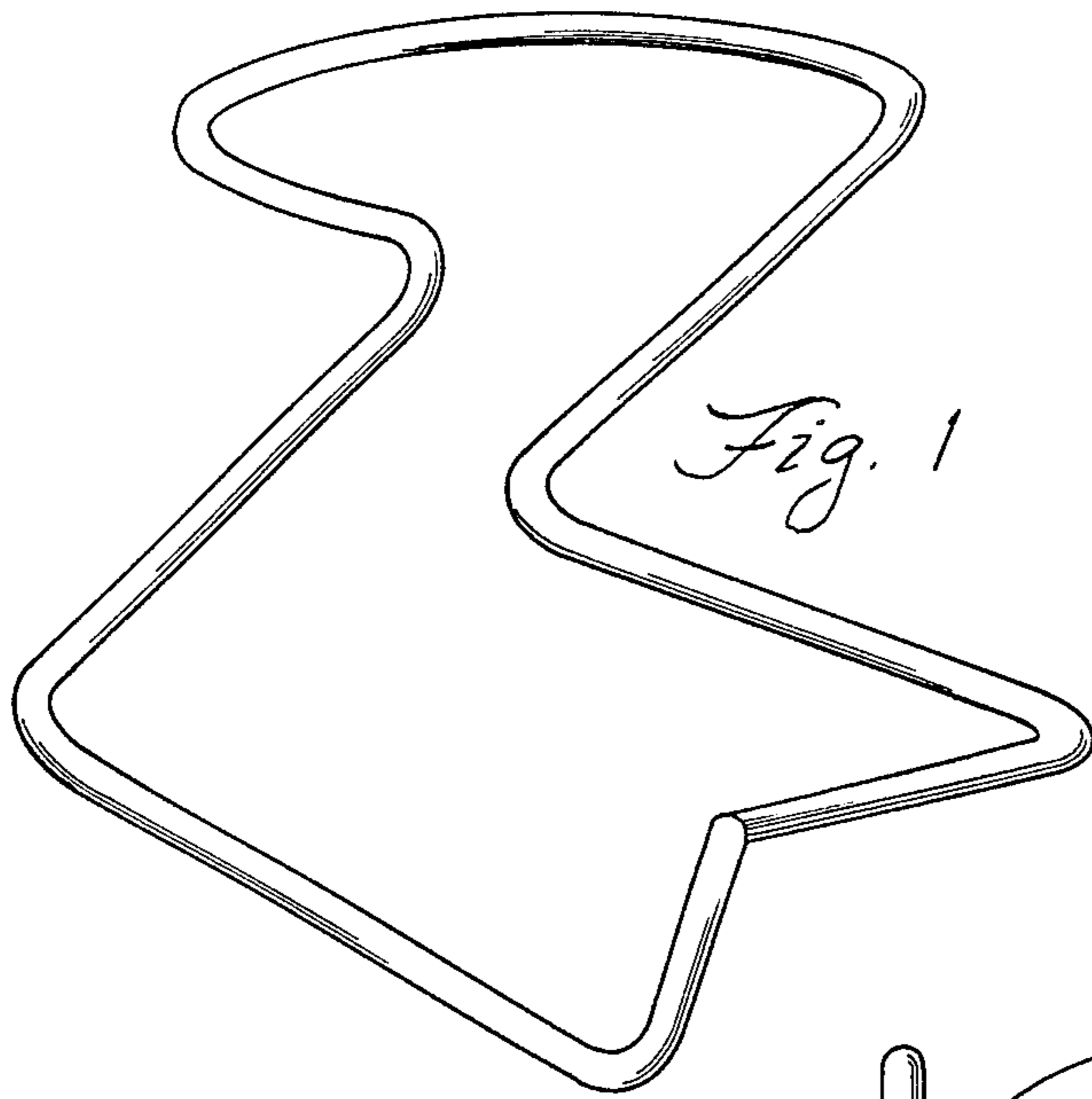
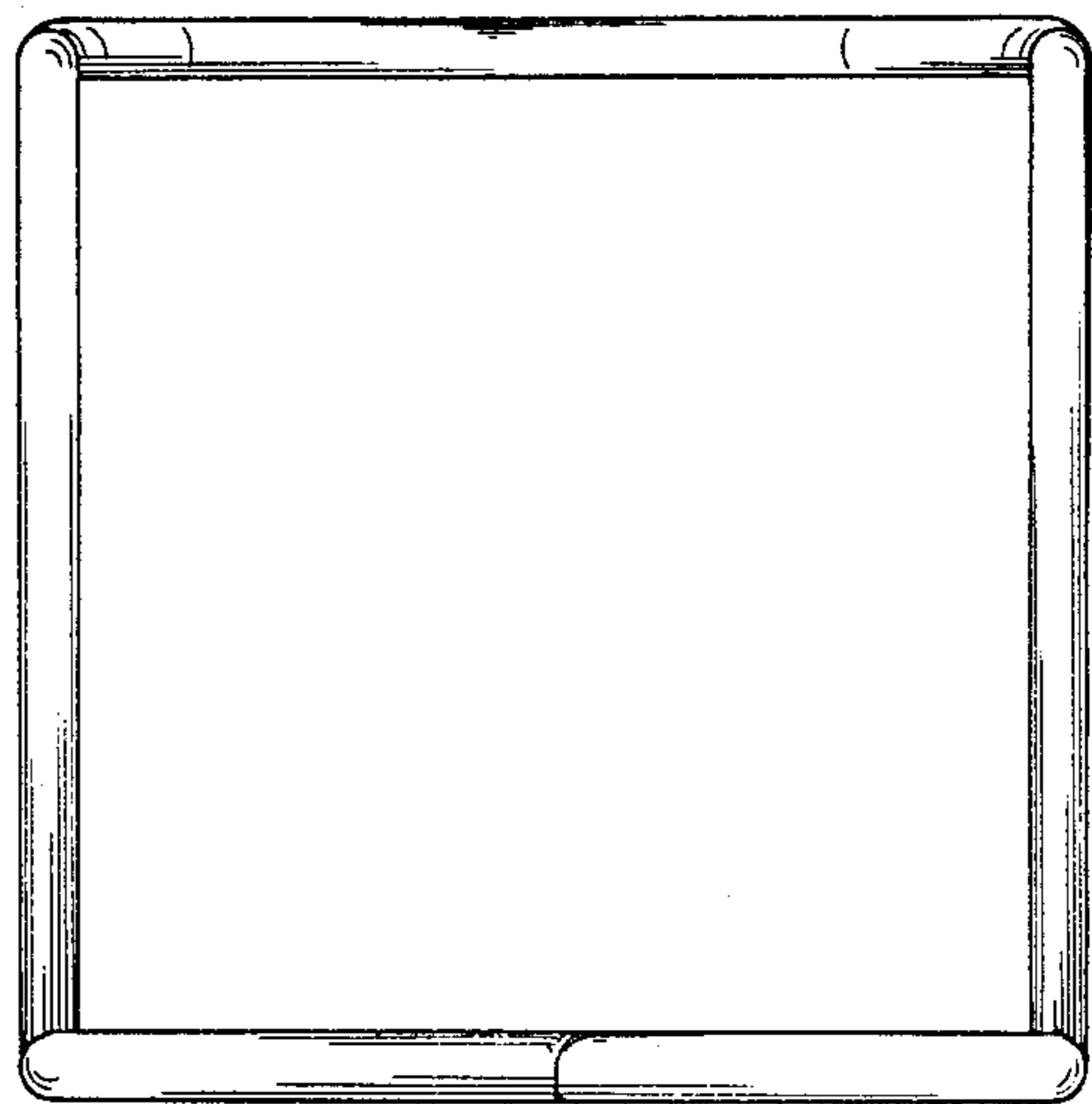
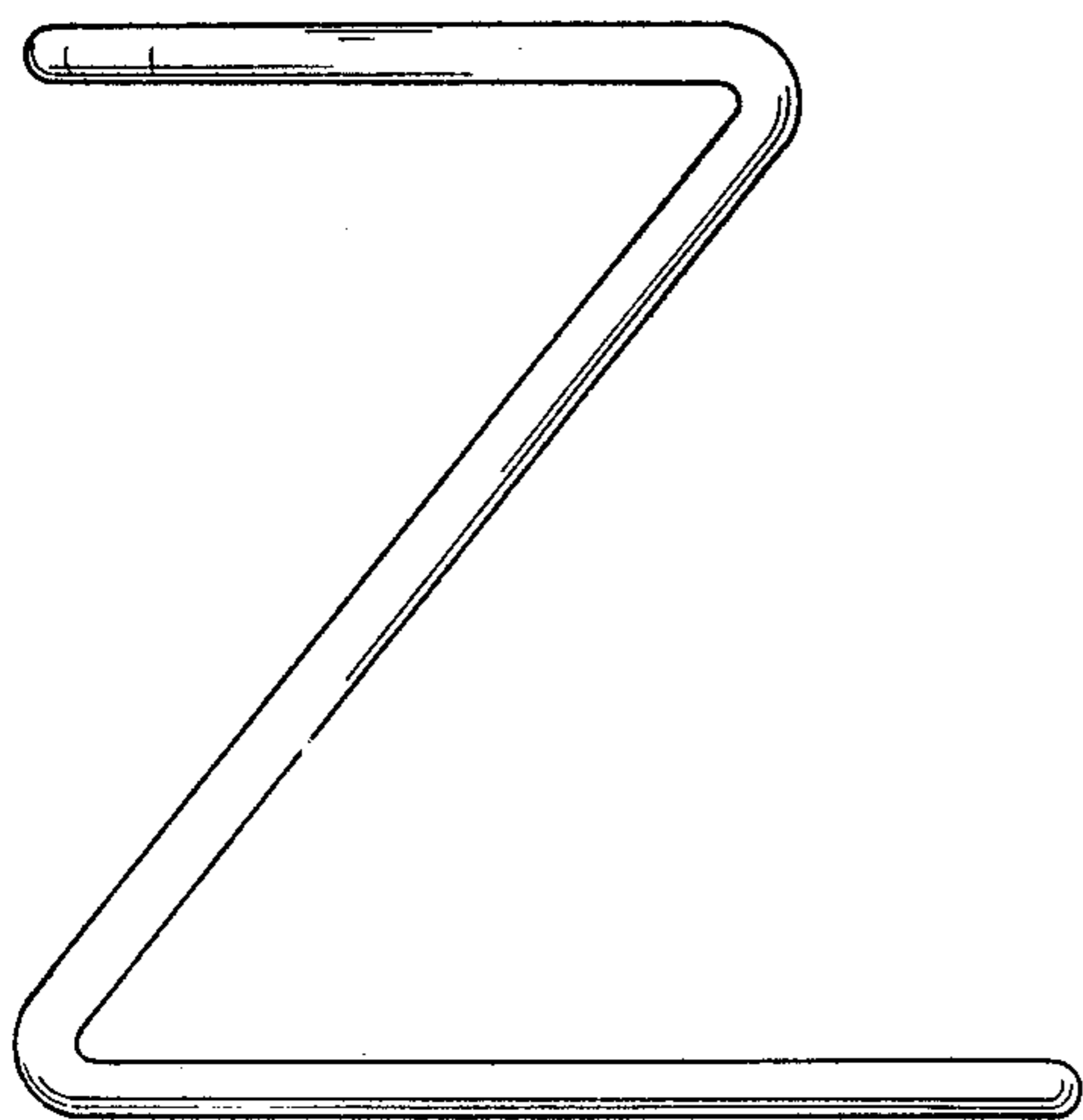
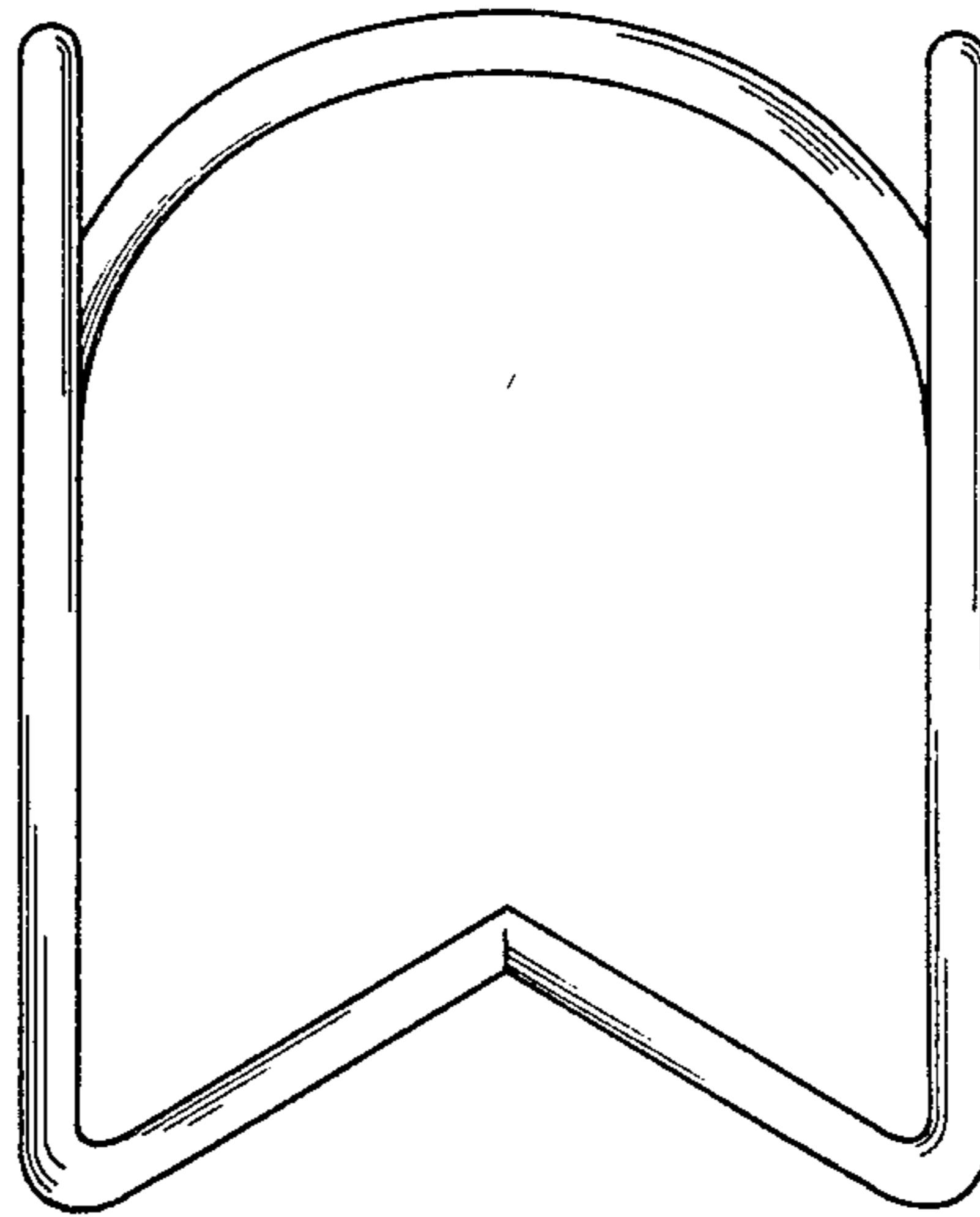

Fig. 3



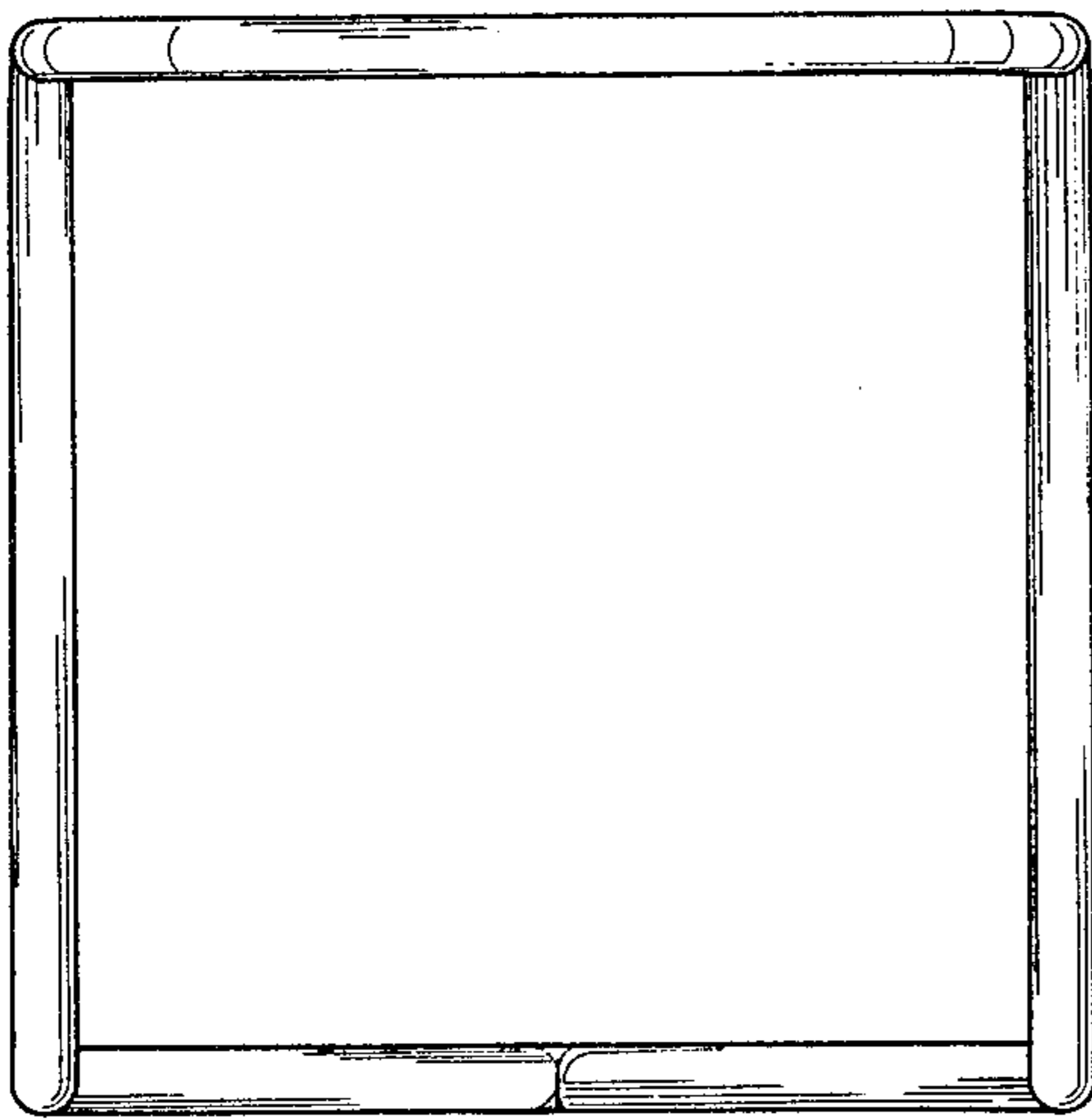

Fig. 6

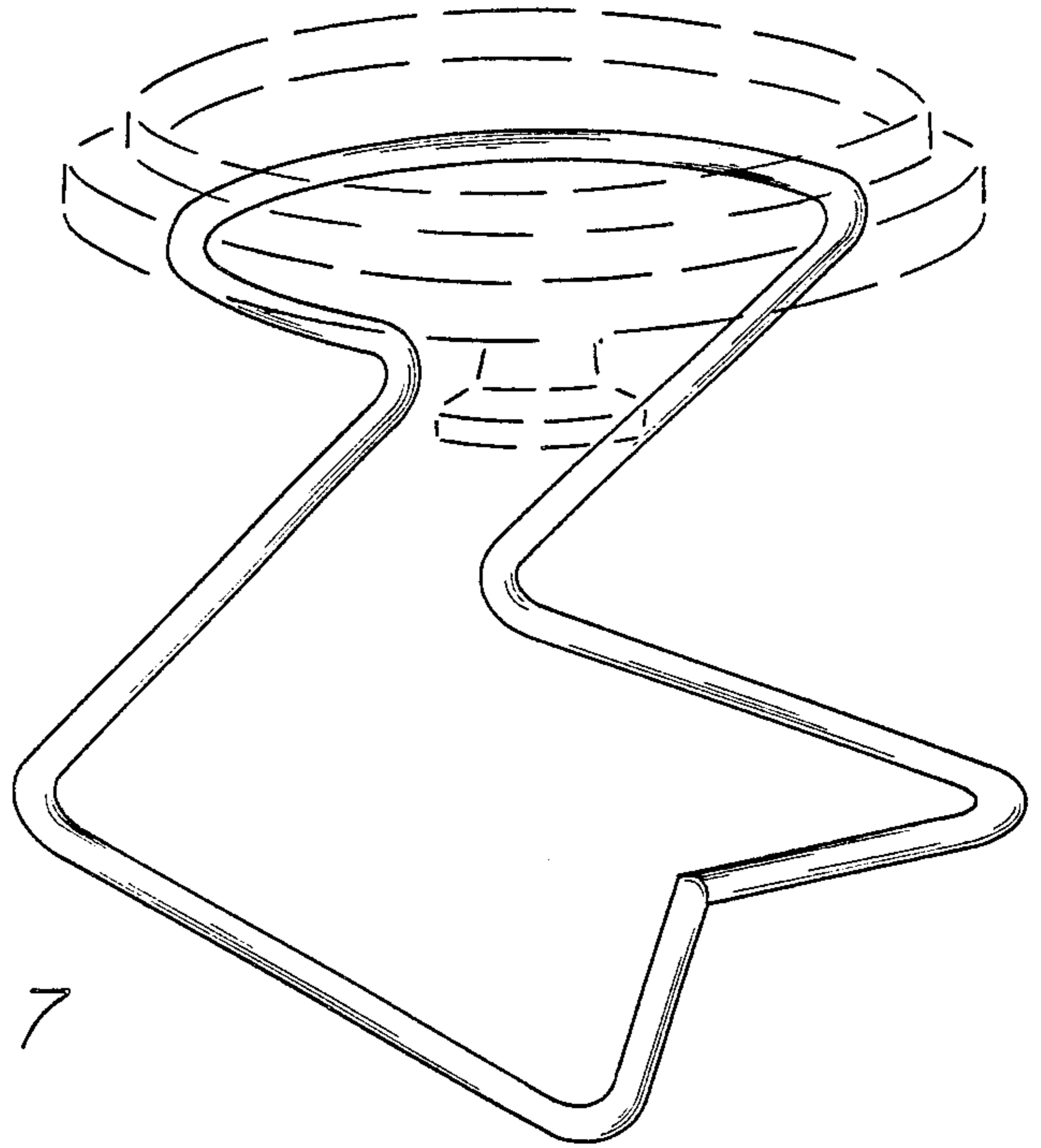

Fig. 7