

[54] CHAIR

[75] Inventors: Larry A. Schwartz, Hartsdale;
Terrence Gibbs, Nyack, both of N.Y.

[73] Assignee: Omni Products International, Inc.,
Fairfield, N.J.

[**] Term: 14 Years

[21] Appl. No.: 51,007

[22] Filed: May 15, 1987

[52] U.S. Cl. D6/370

[58] Field of Search D6/379, 380, 370, 334

[56] References Cited

U.S. PATENT DOCUMENTS

D. 183,887	11/1958	Jensen	D6/370
D. 285,875	9/1986	Goldman	D6/379
D. 291,391	8/1987	Arthur, Jr.	D6/370
D. 294,436	3/1988	Colby	D6/379
D. 296,628	7/1988	Glass	D6/370
D. 296,848	7/1988	Colby	D6/379

OTHER PUBLICATIONS

Brown Jordan Catalog, ©1983, p. 1, Chair, left or right front.

Sun Terrace Products, 1986, p. 17, Chair, front left.

Primary Examiner—Bruce W. Dunkins

Assistant Examiner—Ann Hunt

Attorney, Agent, or Firm—Lerner, David, Littenberg,
Krumholz & Mentlik

[57] CLAIM

The ornamental design for a chair, as shown and described.

DESCRIPTION

FIG. 1 is a front perspective view of the chair showing our new design;

FIG. 2 is a front elevational view;

FIG. 3 is a rear elevational view;

FIG. 4 is a right side elevational view;

FIG. 5 is a left side elevational view;

FIG. 6 is a top plan view; and

FIG. 7 is a bottom plan view thereof;

FIG. 8 is a front perspective view of a second embodiment of the chair showing our new design;

FIG. 9 is a front elevational view;

FIG. 10 is a rear elevational view;

FIG. 11 is a right side elevational view;

FIG. 12 is a left side elevational view;

FIG. 13 is a top plan view; and

FIG. 14 is a bottom plan view thereof;

FIG. 15 is a front perspective view of a third embodiment of the chair showing our new design;

FIG. 16 is a front elevational view;

FIG. 17 is a rear elevational view;

FIG. 18 is a right elevational view;

FIG. 19 is a left side elevational view;

FIG. 20 is a top plan view; and

FIG. 21 is a bottom plan view thereof.

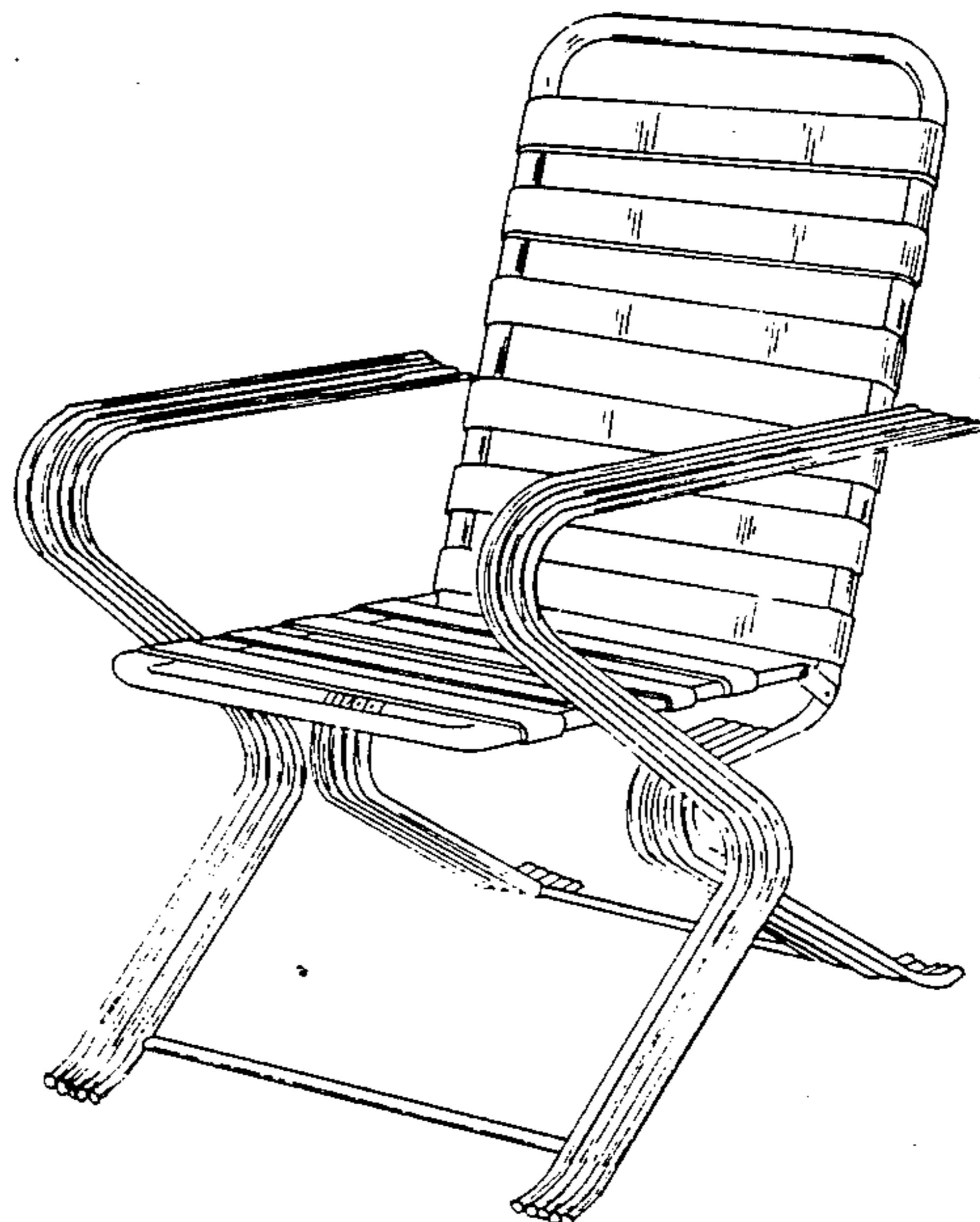

FIG. 1

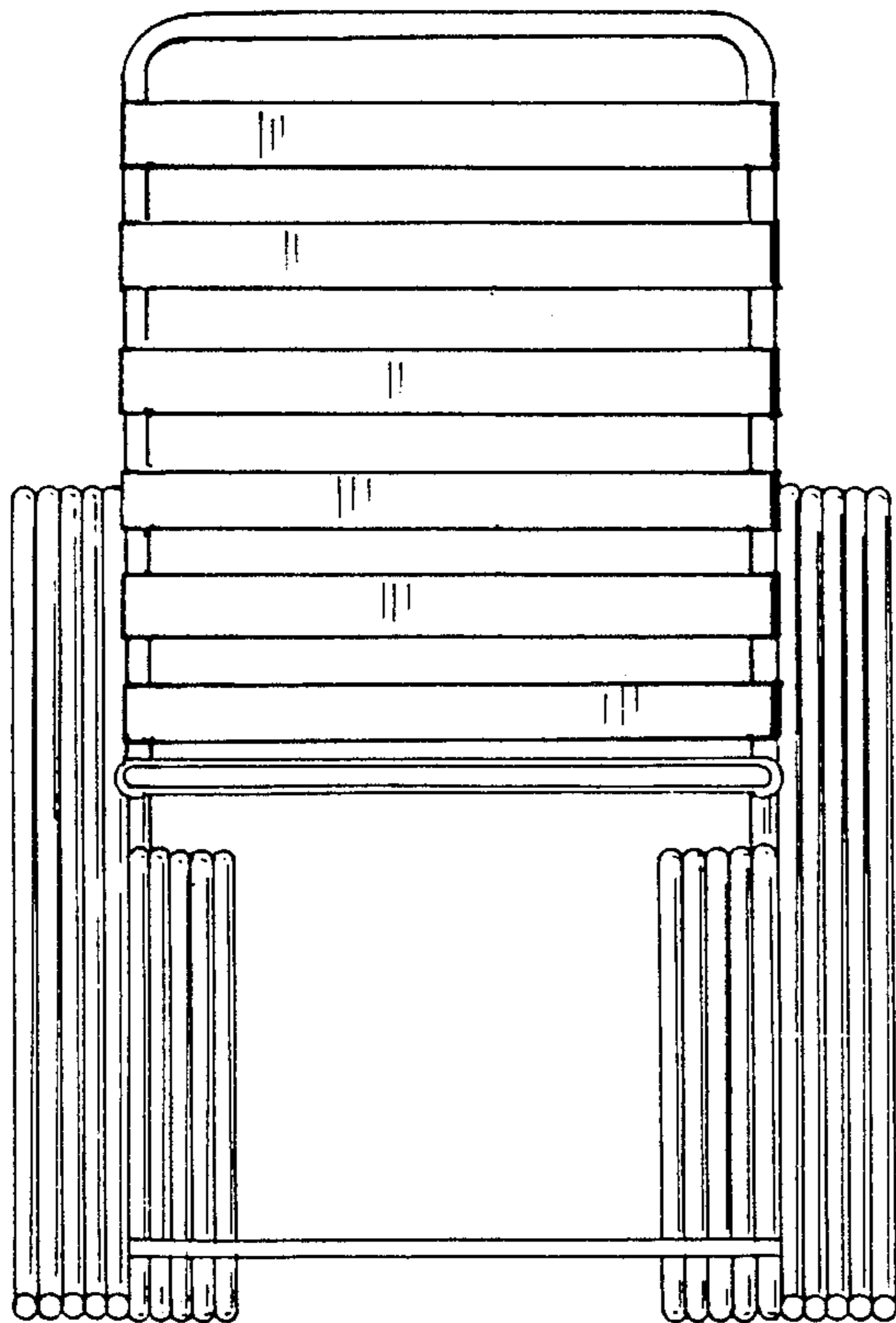
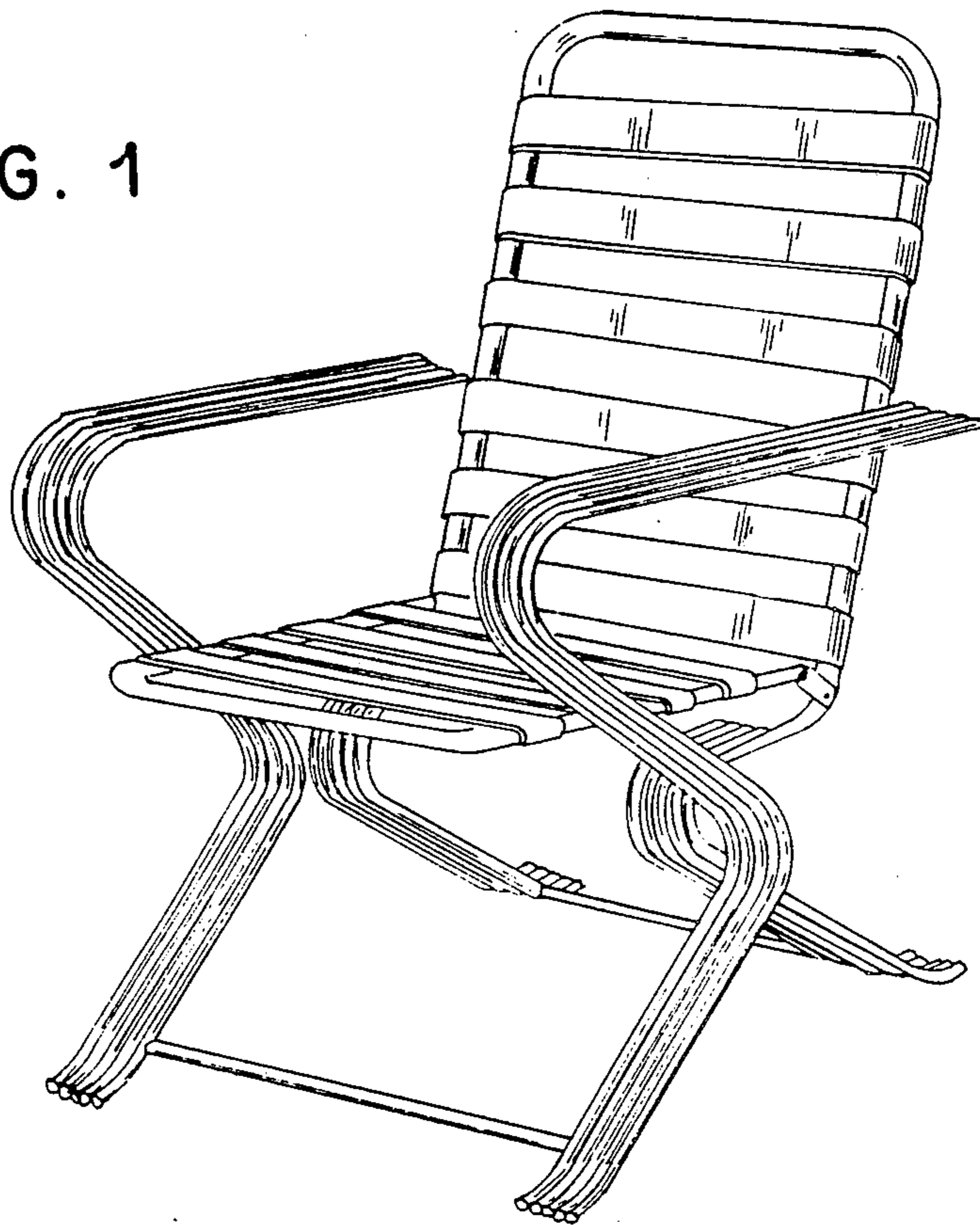

FIG. 2

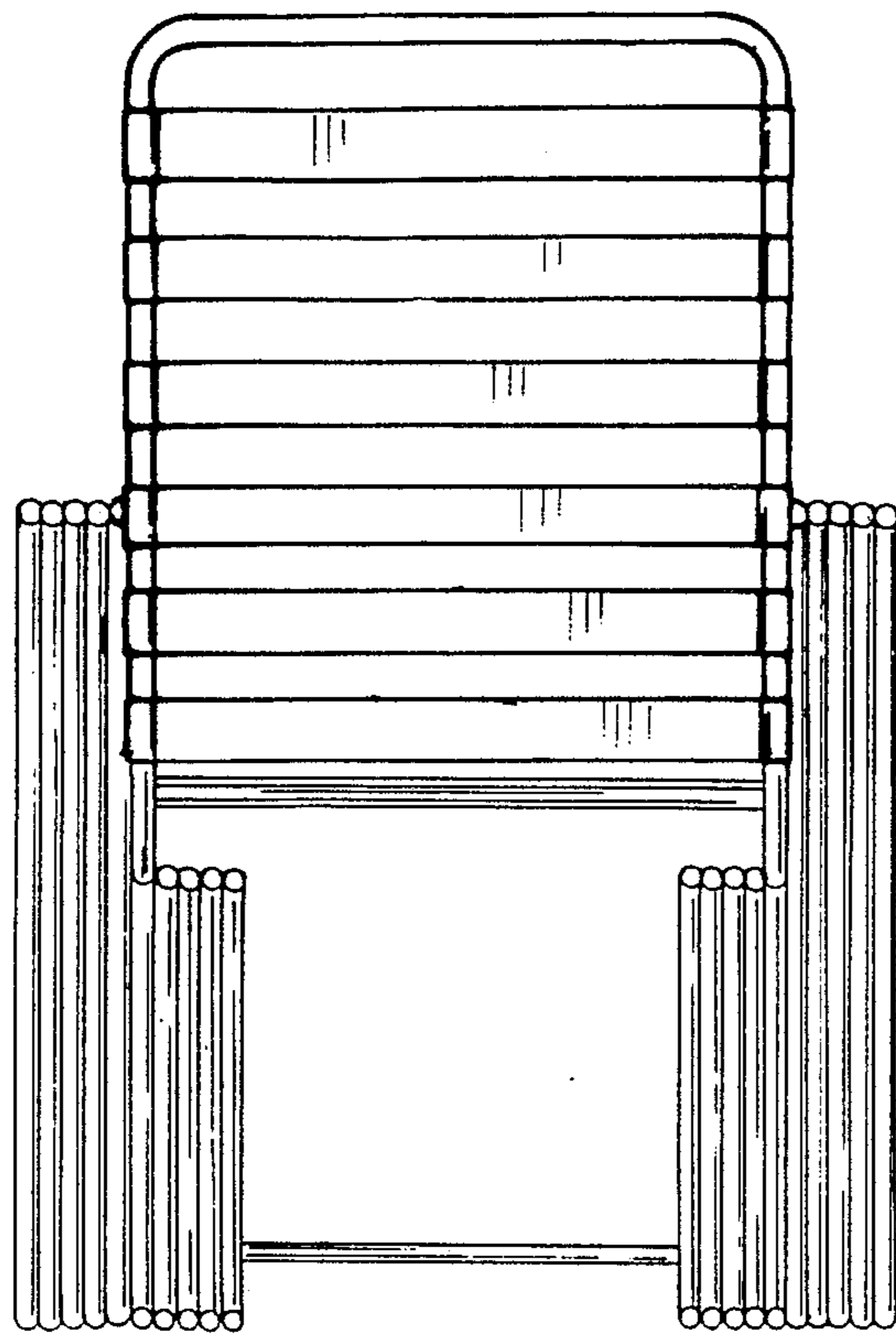
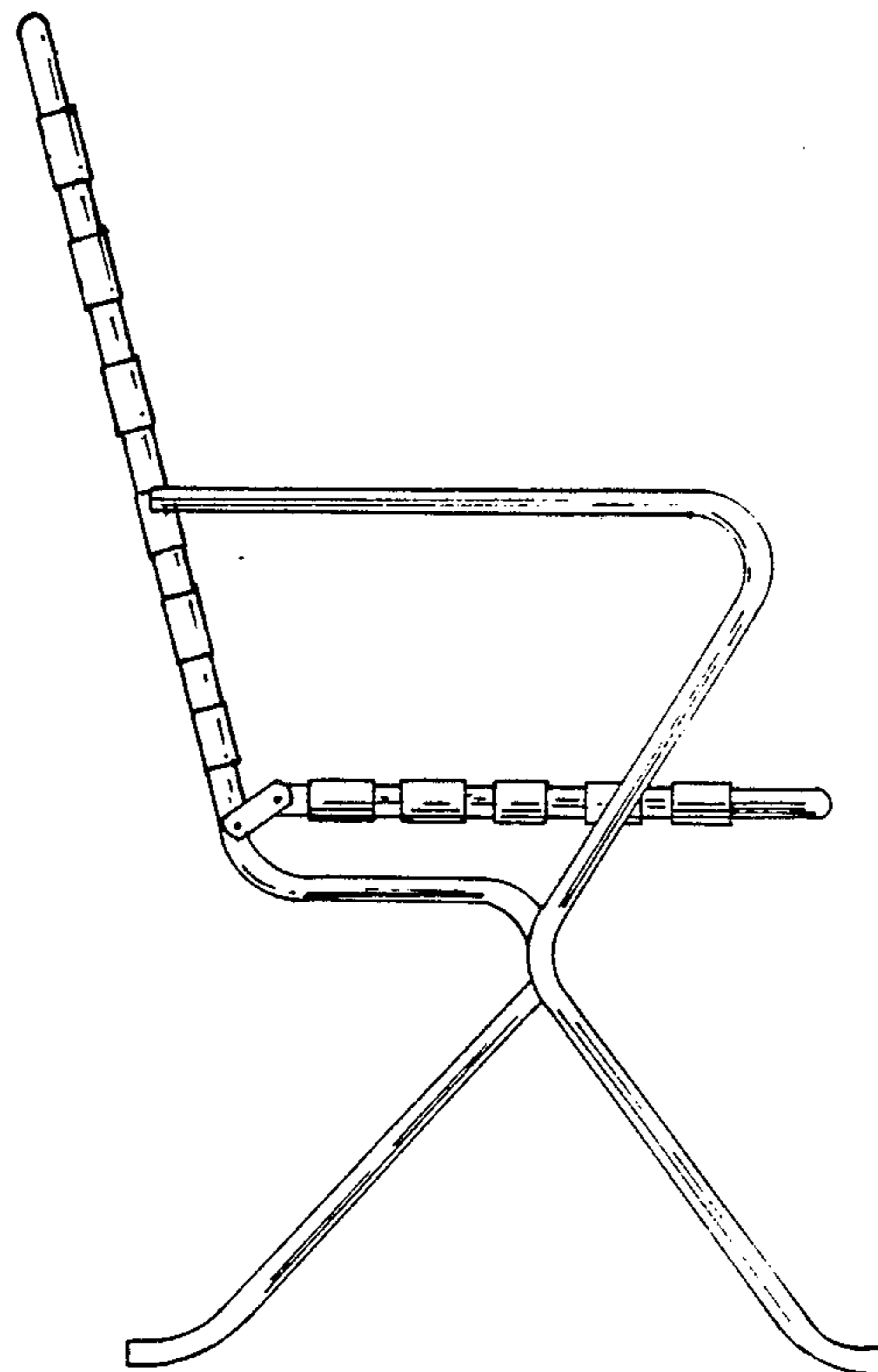

FIG. 3

FIG. 4



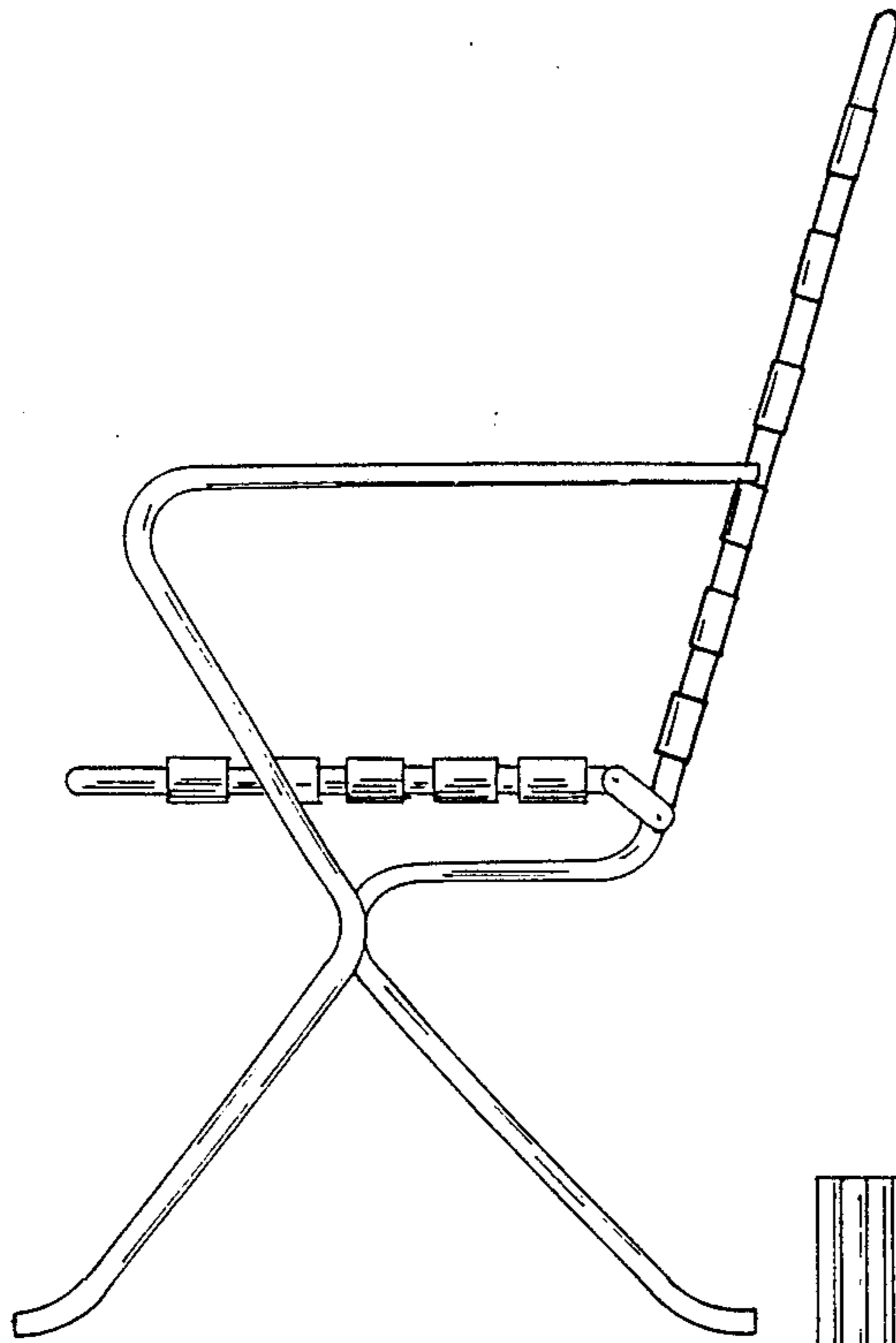

FIG. 5

FIG. 6

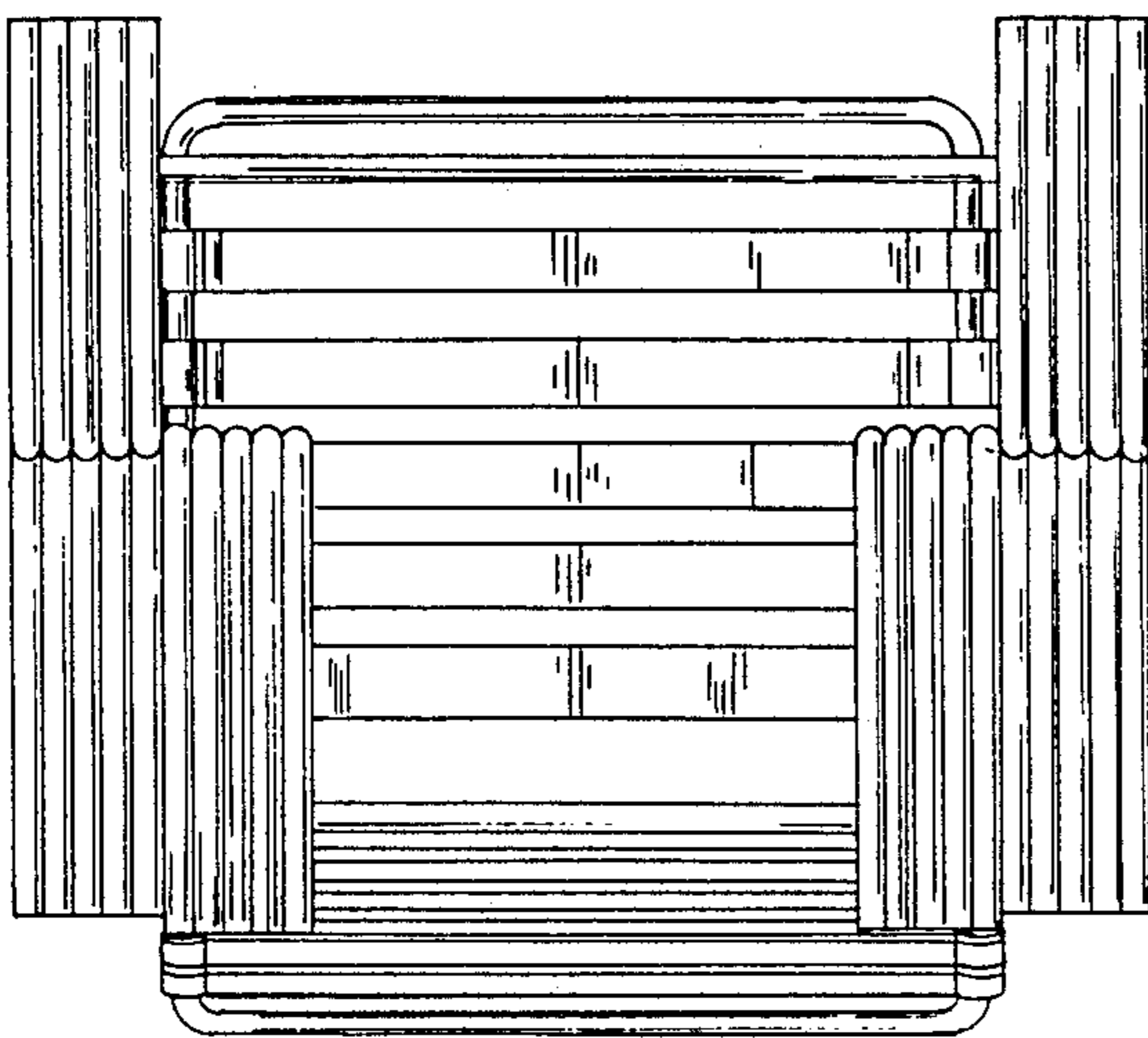
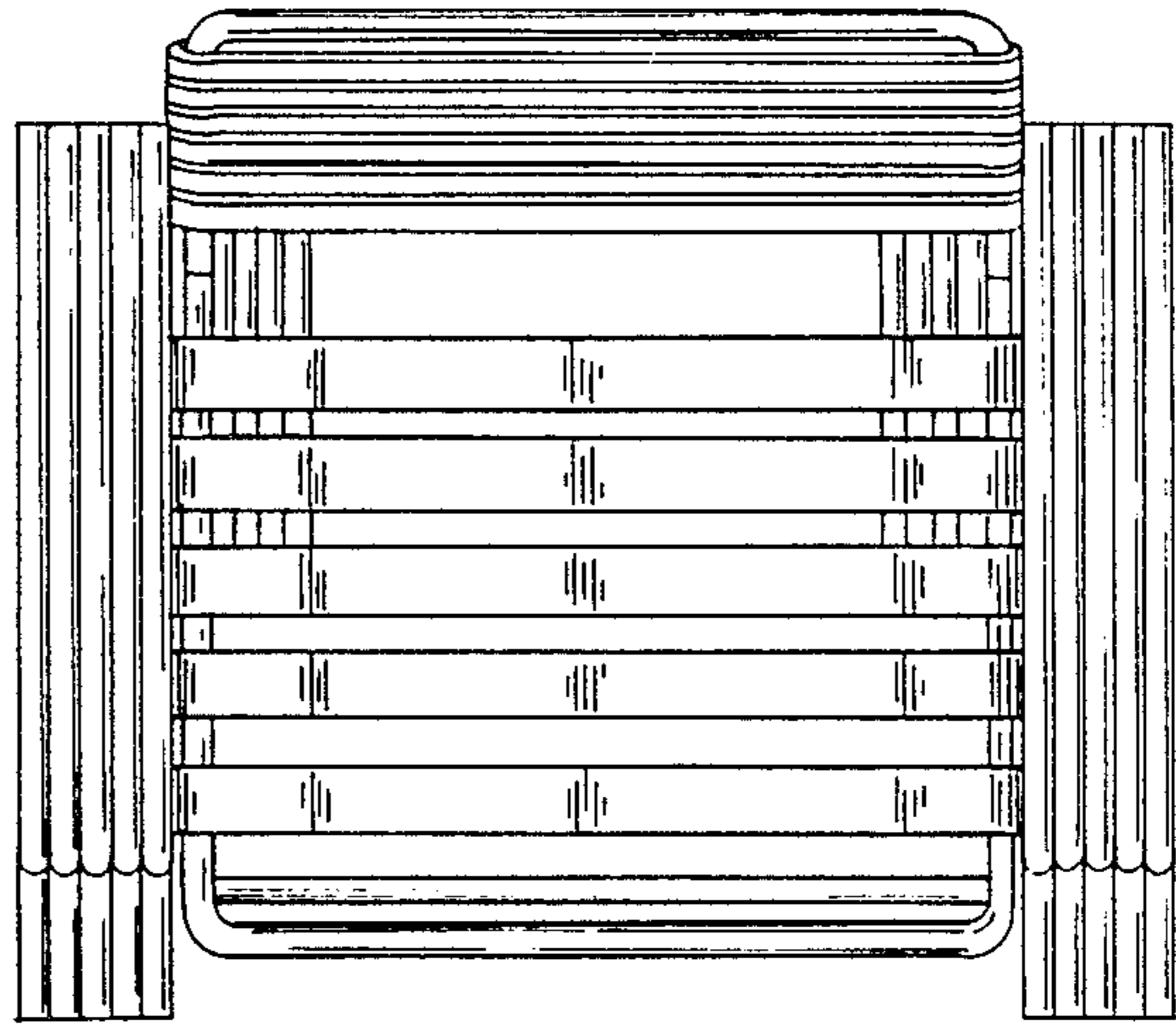

FIG. 7

FIG. 8

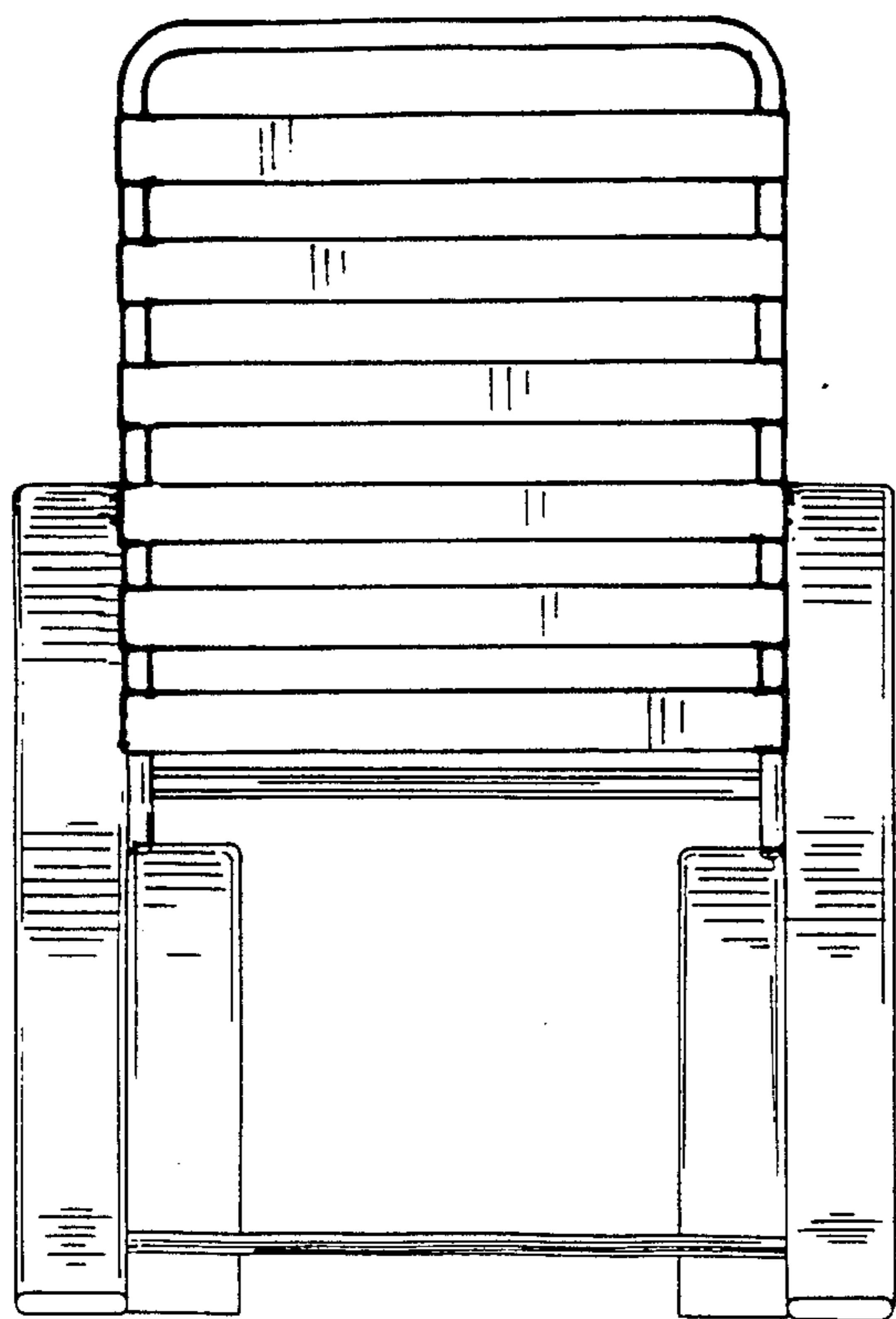
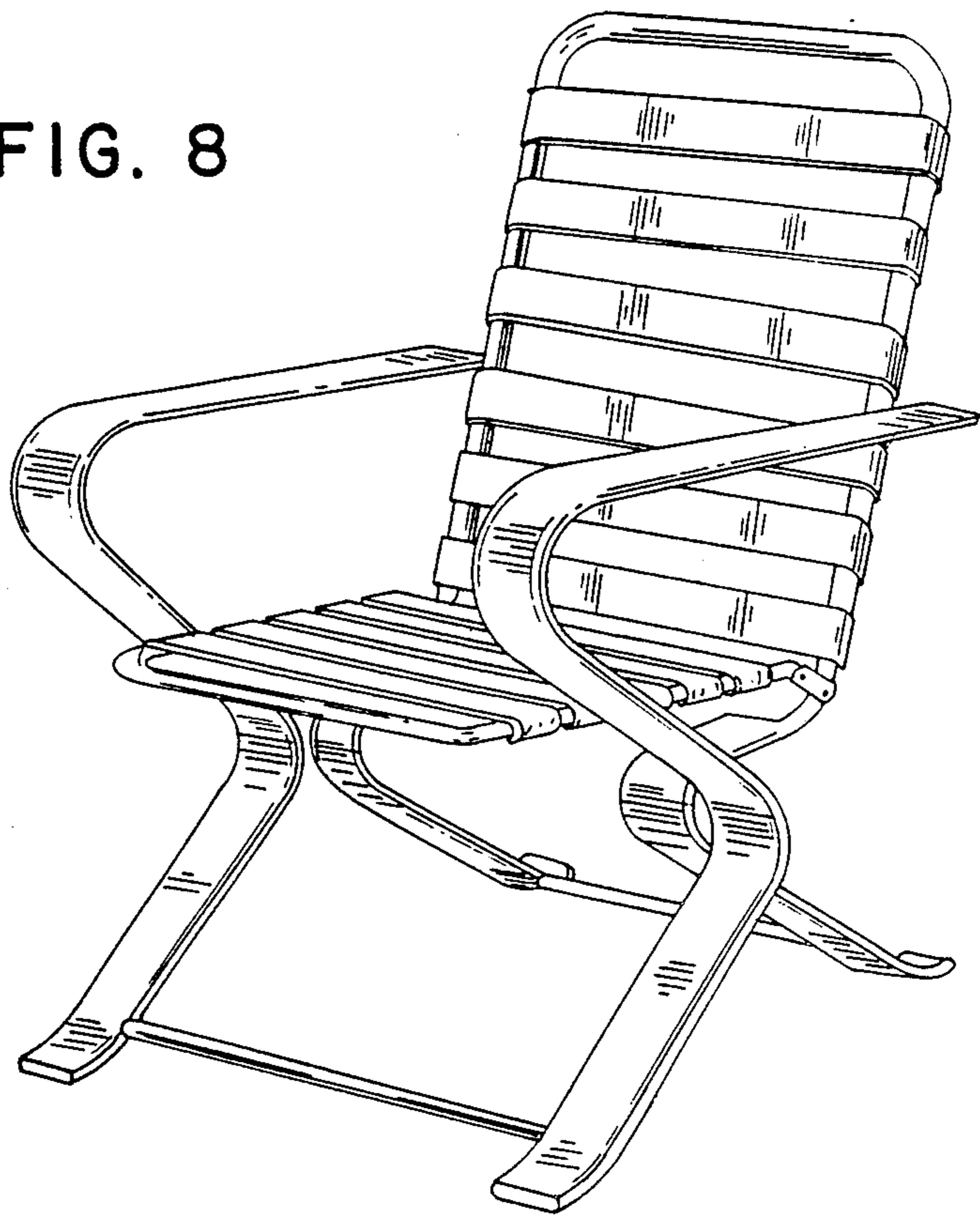

FIG. 9

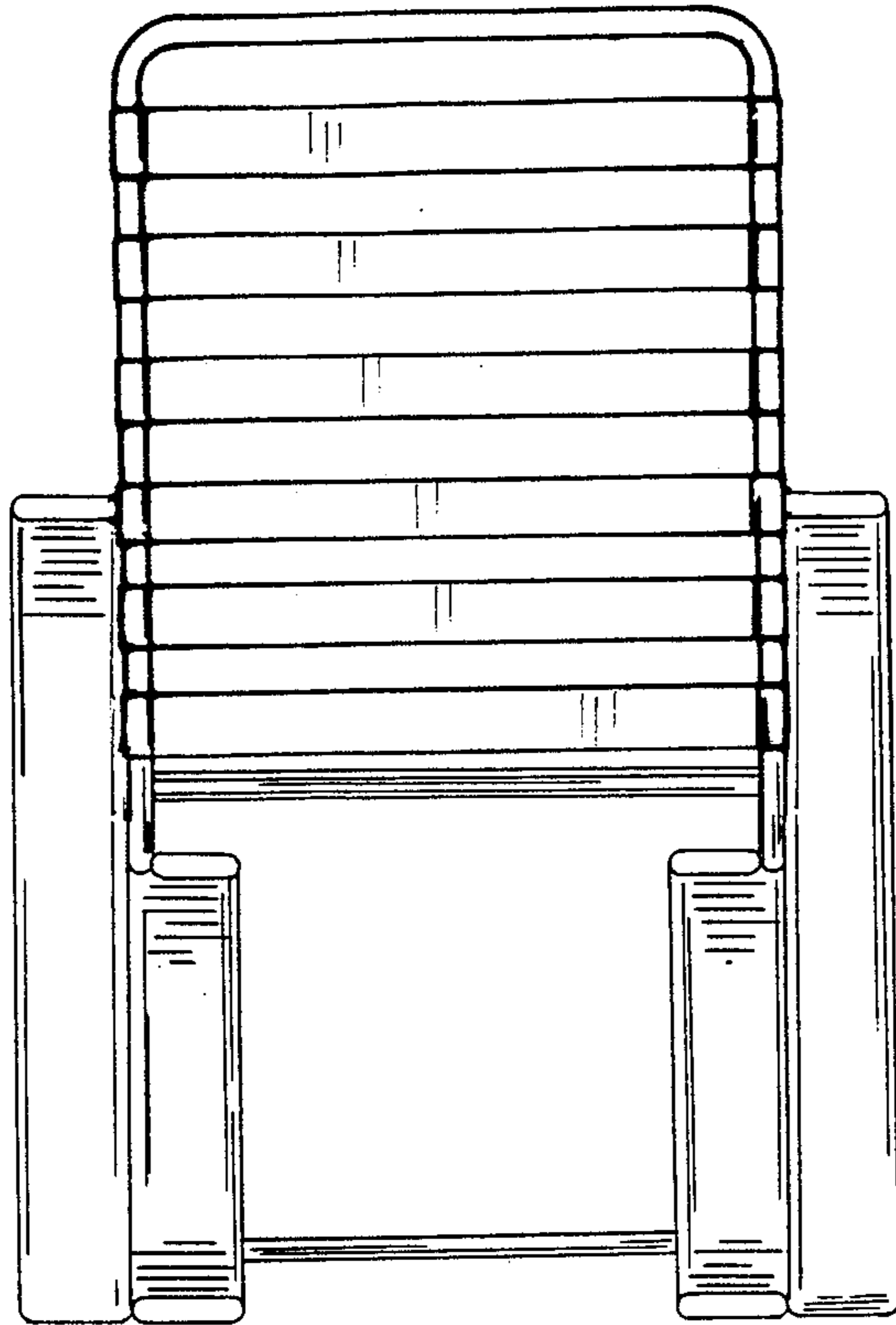
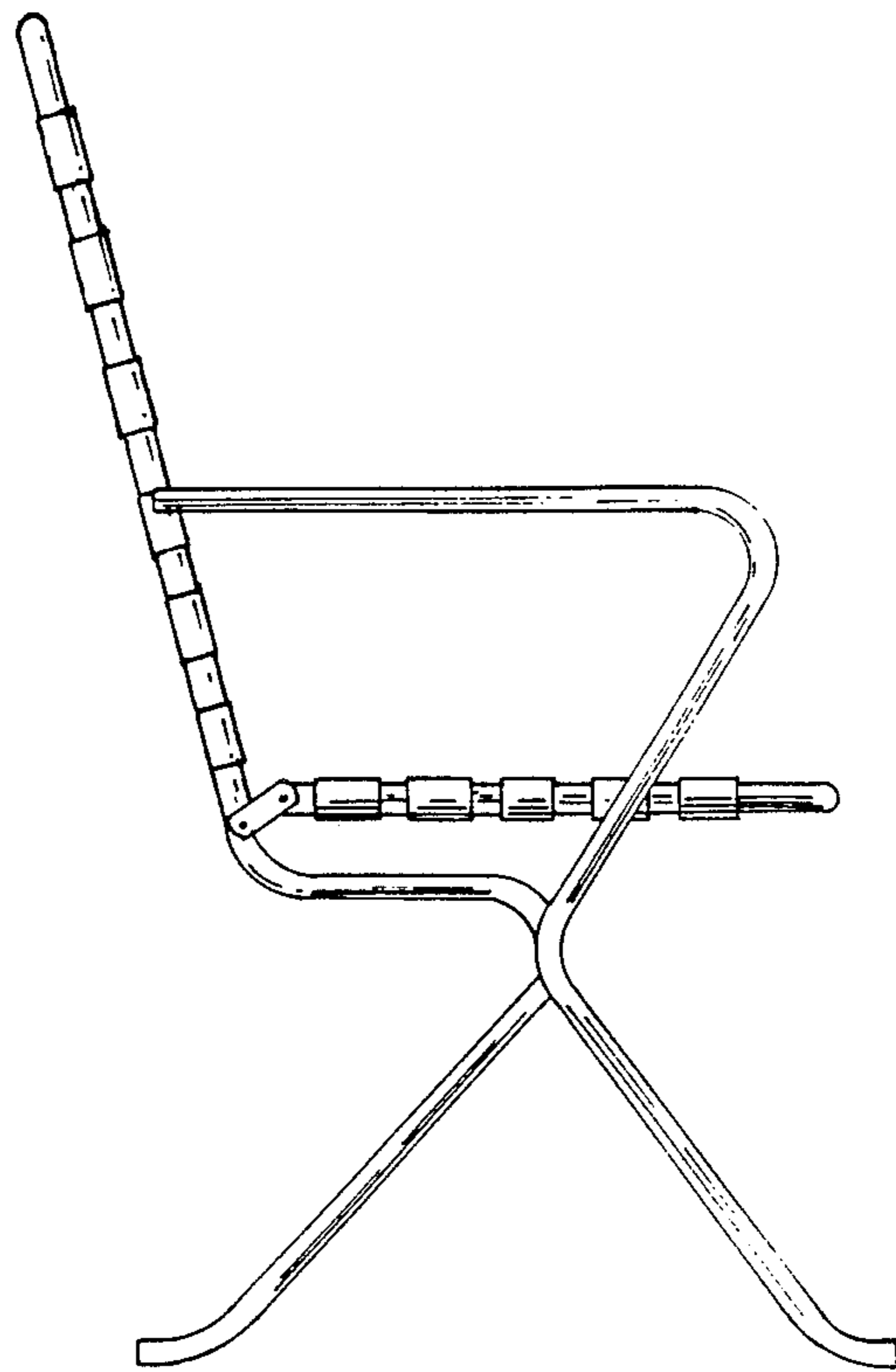

FIG. 10

FIG. 11



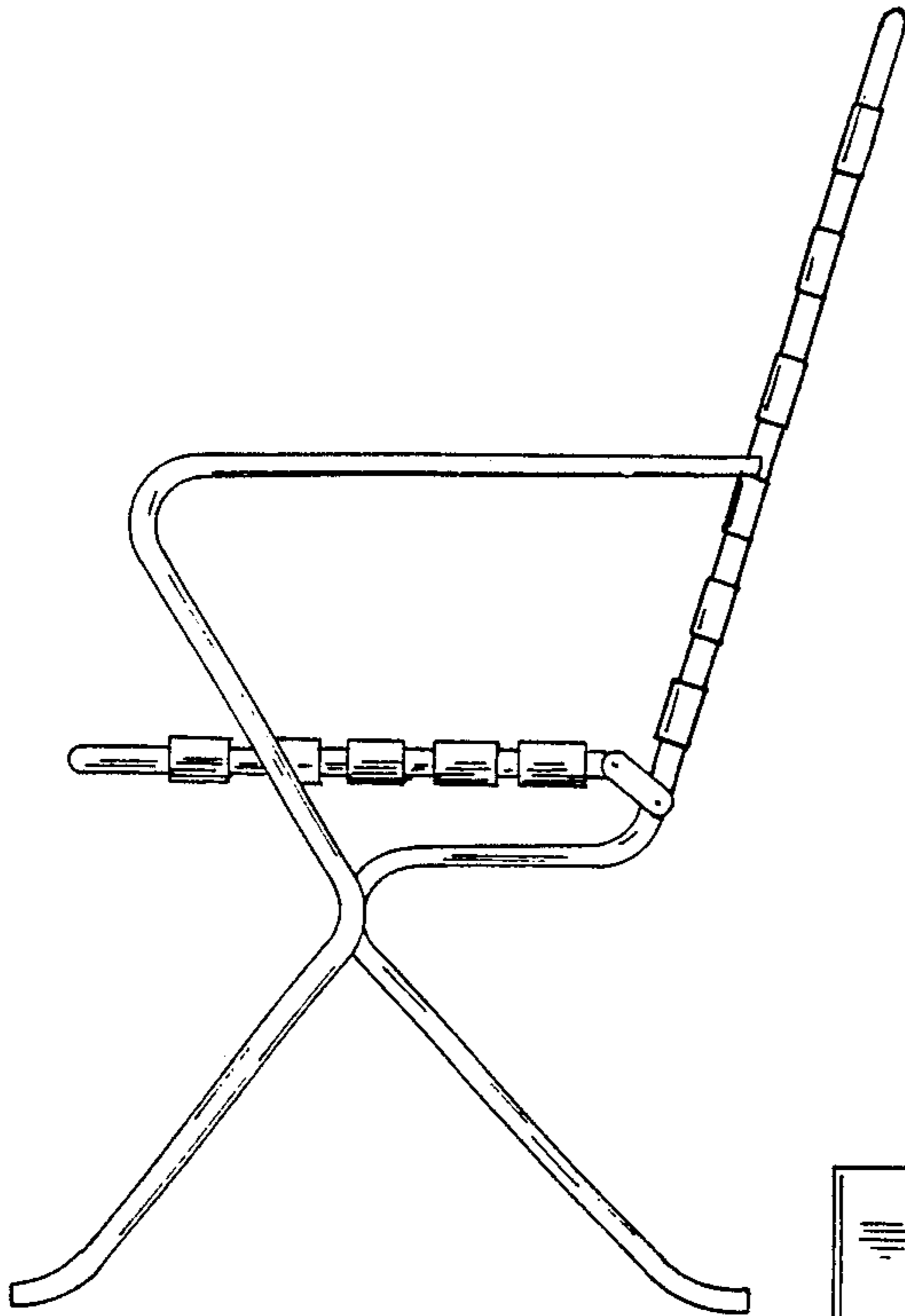

FIG. 12

FIG. 13

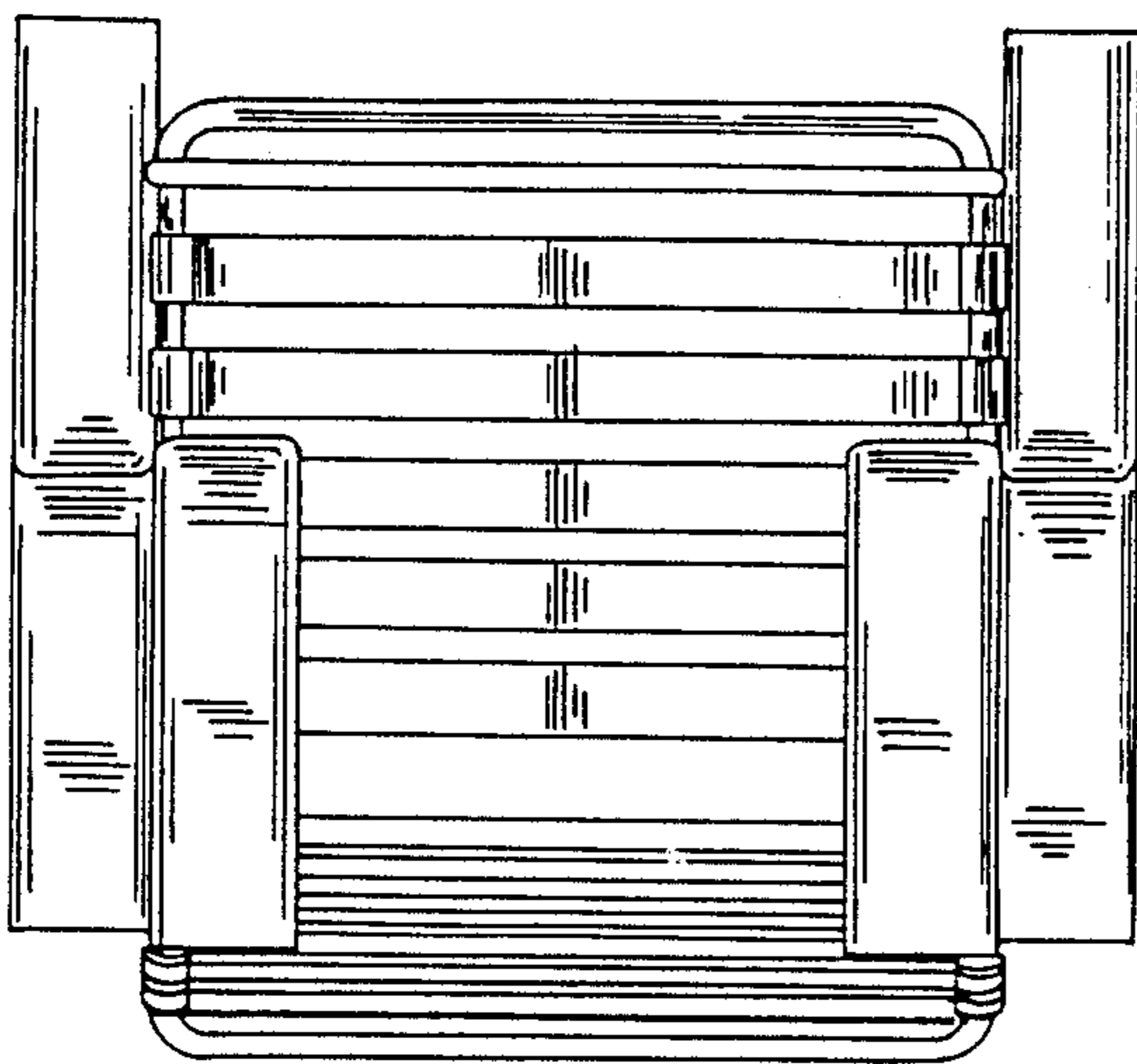
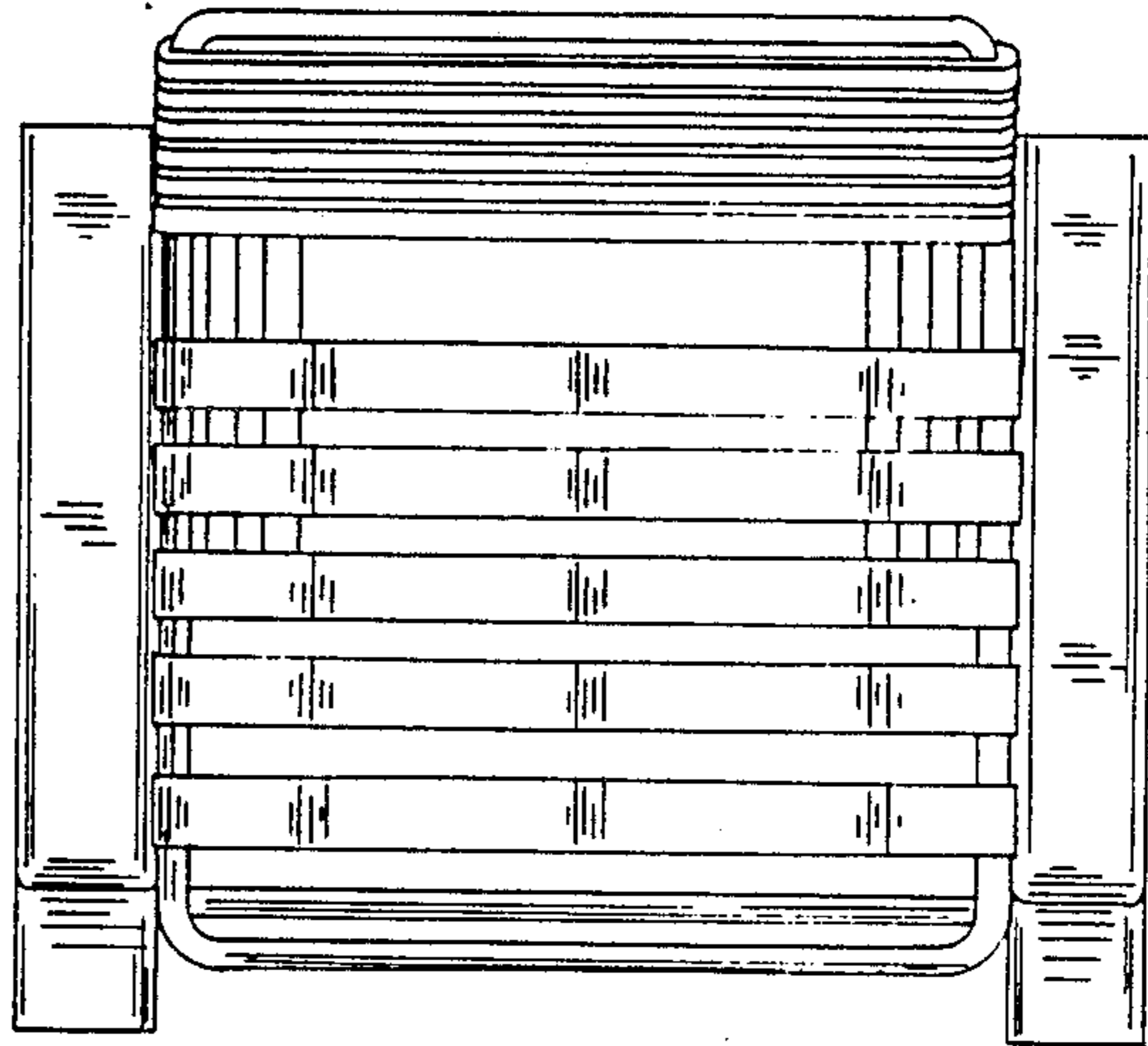

FIG. 14

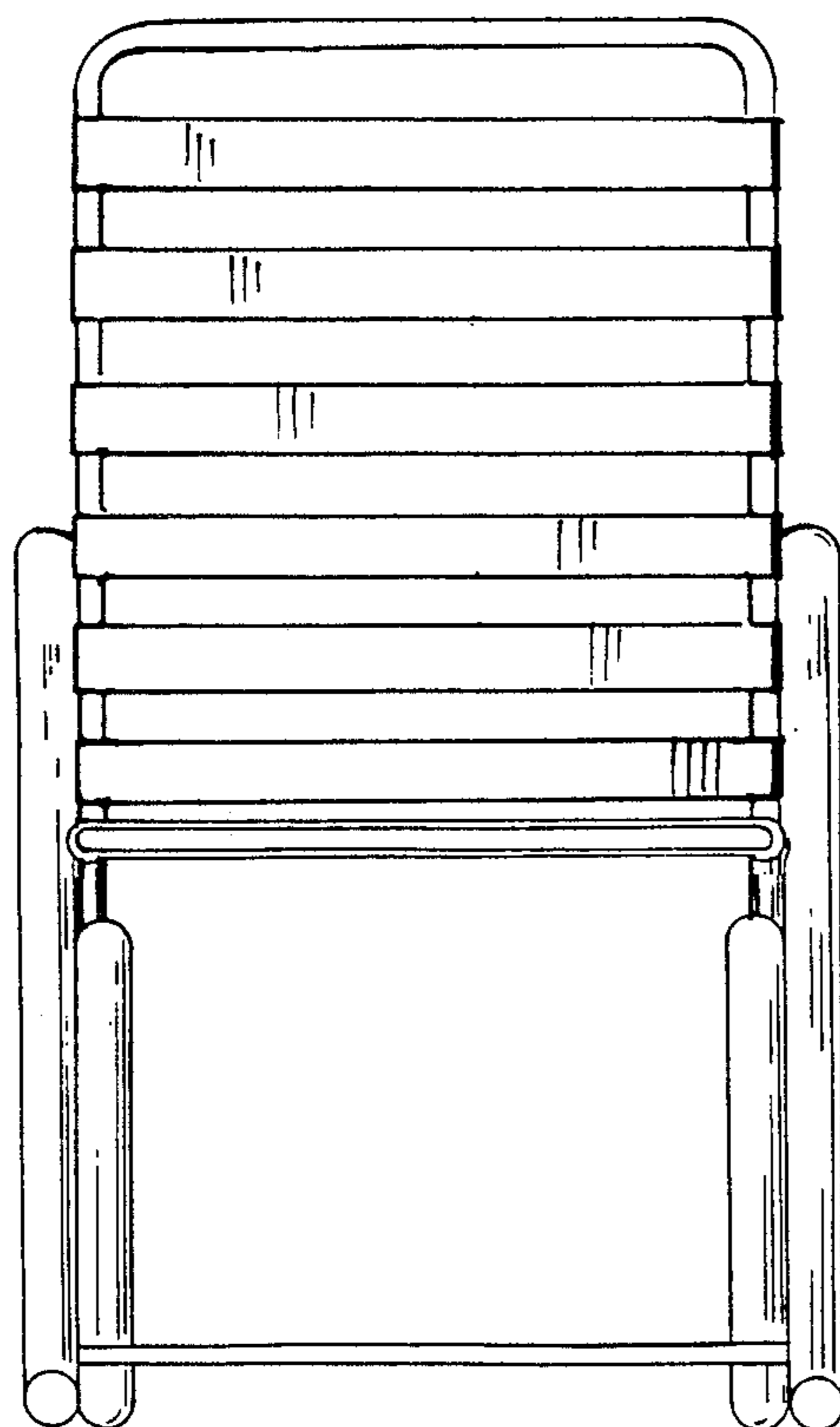
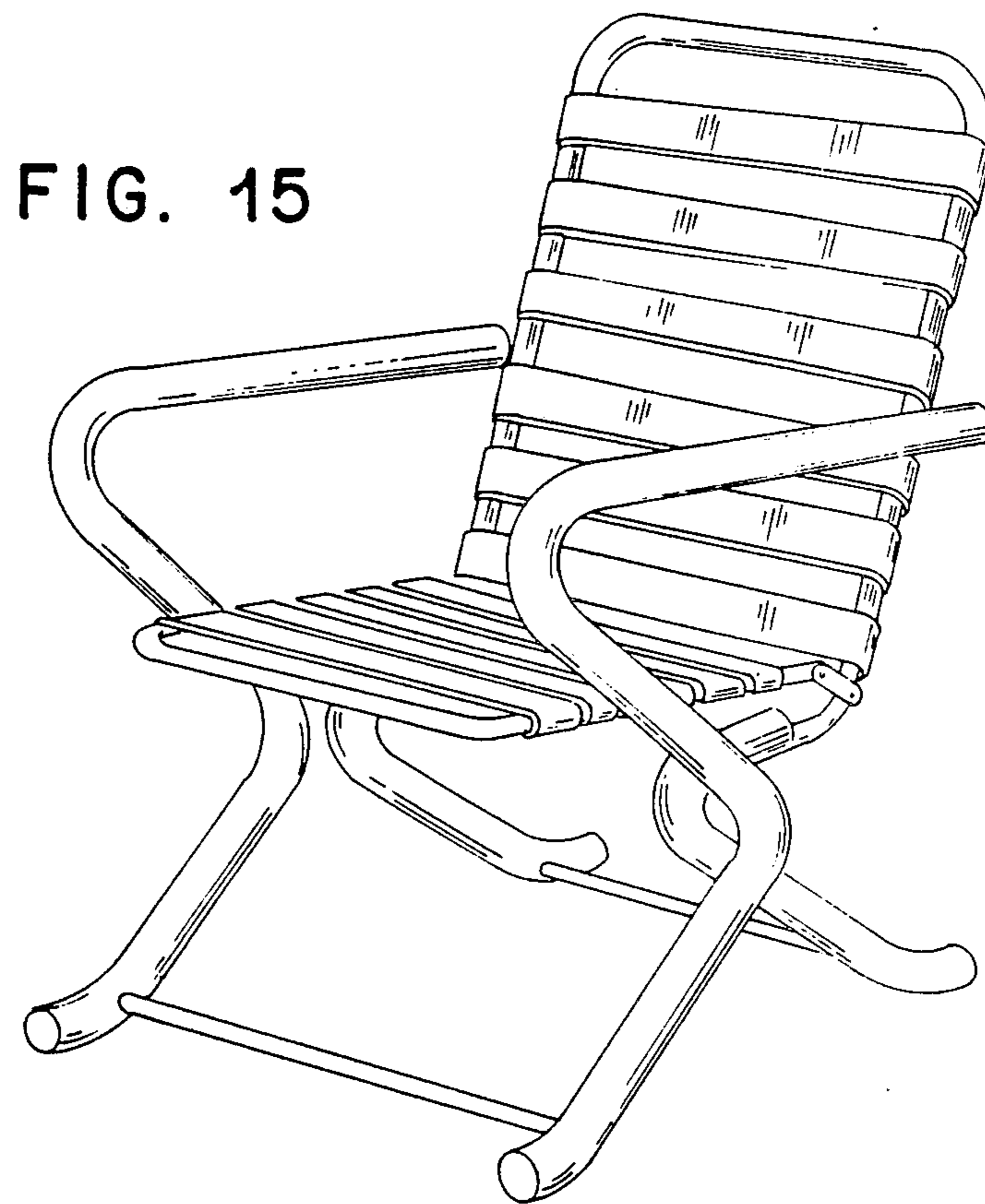

FIG. 16

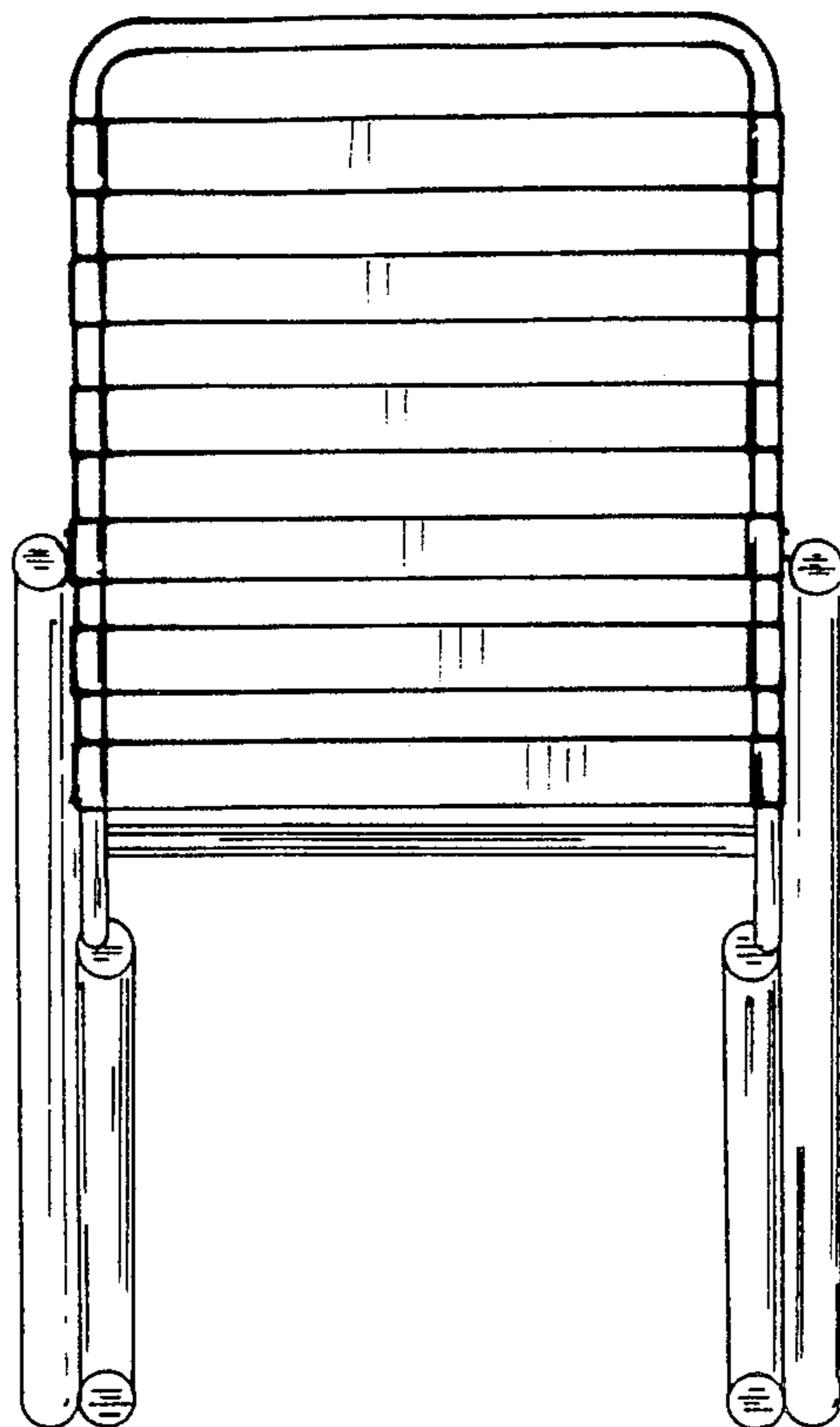

FIG. 17

FIG. 18

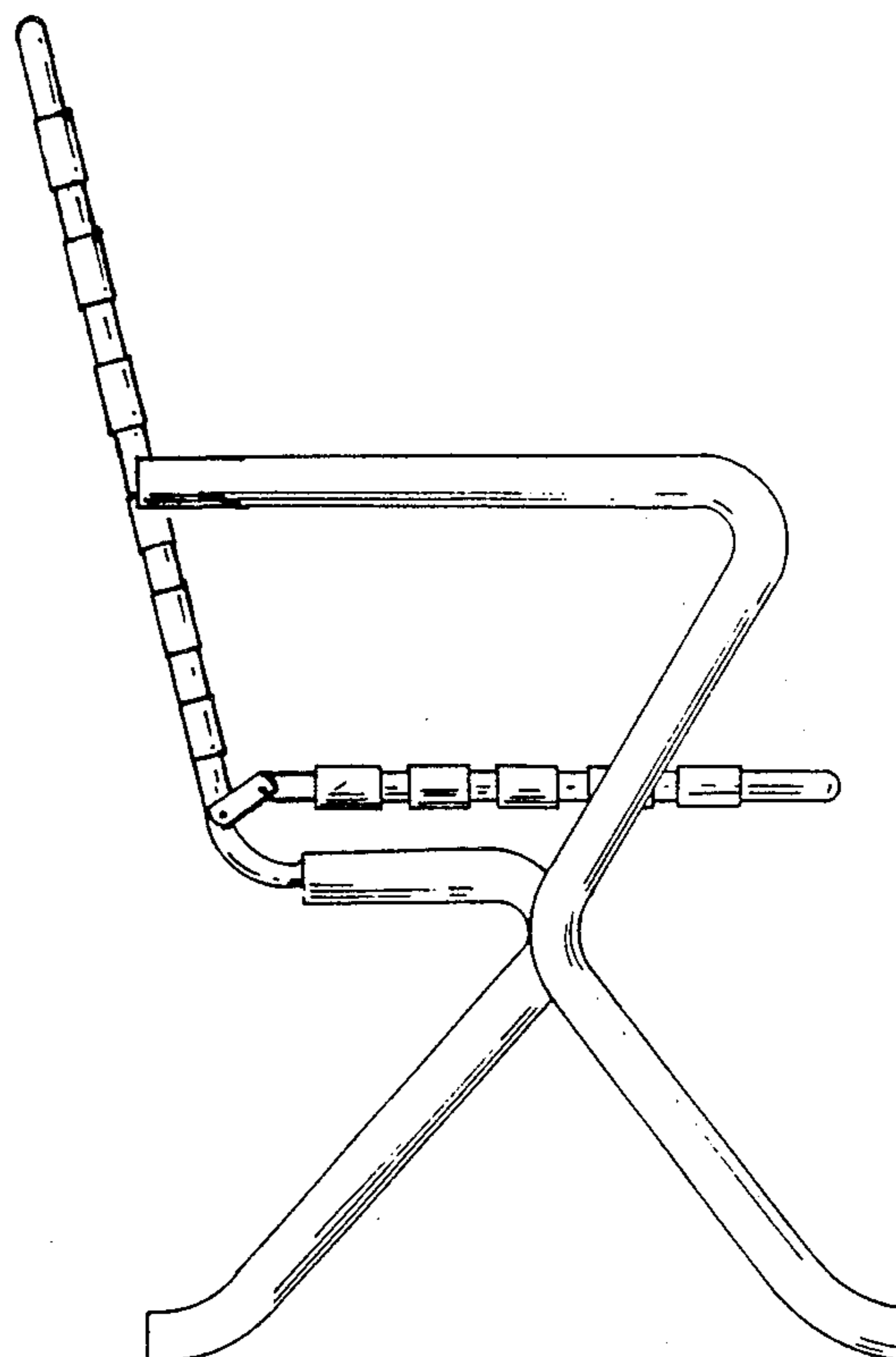

FIG. 19

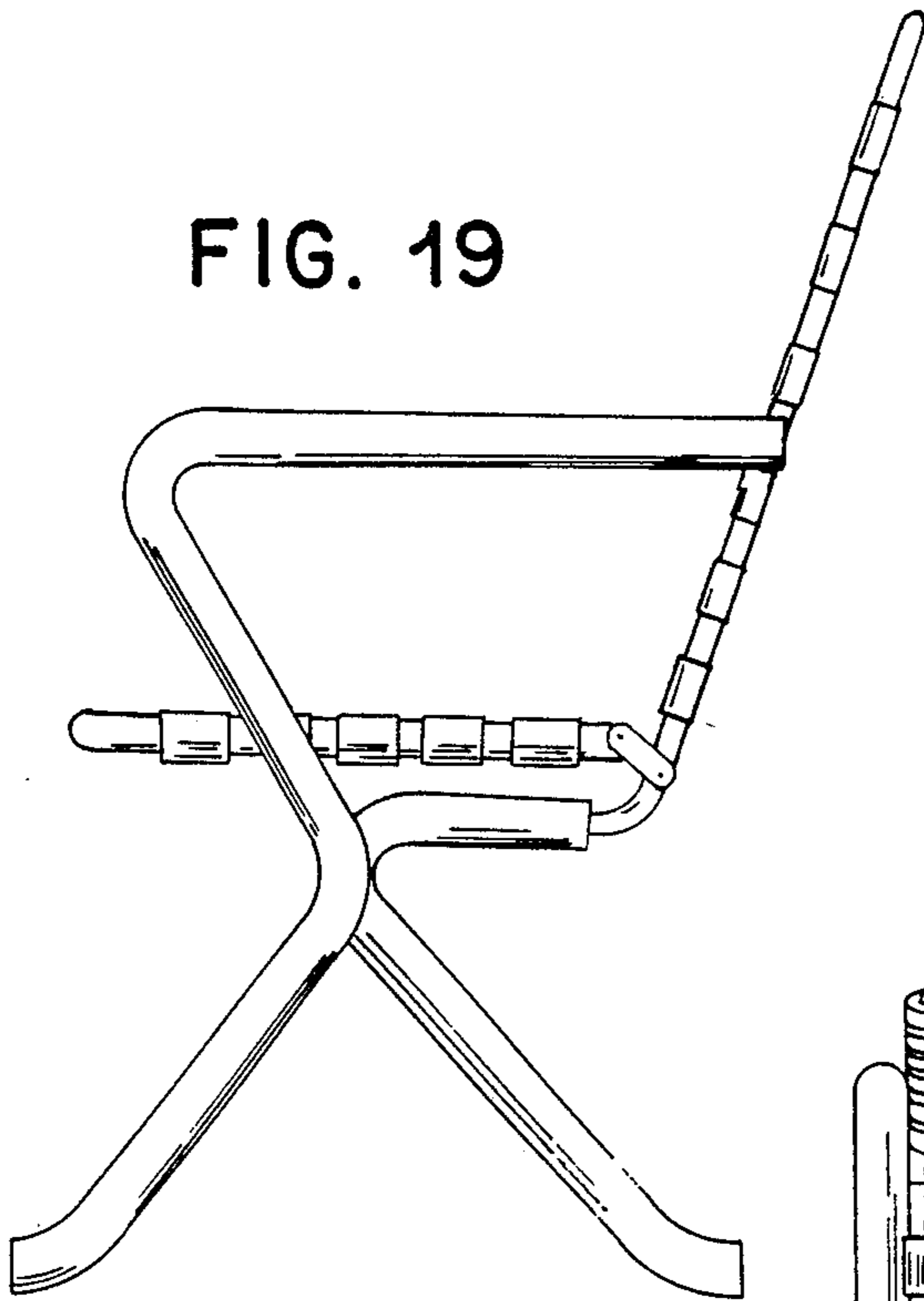

FIG. 20

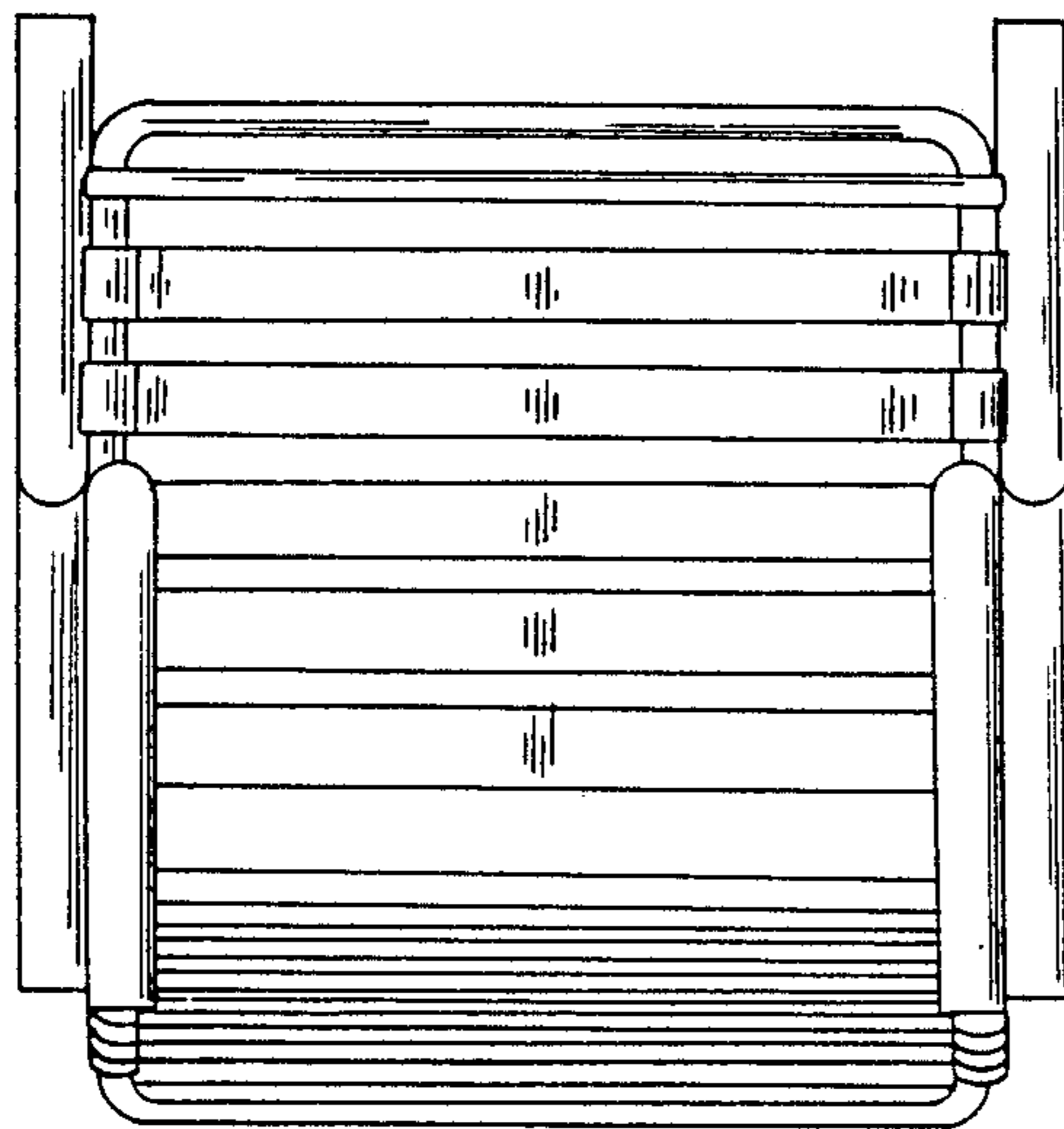
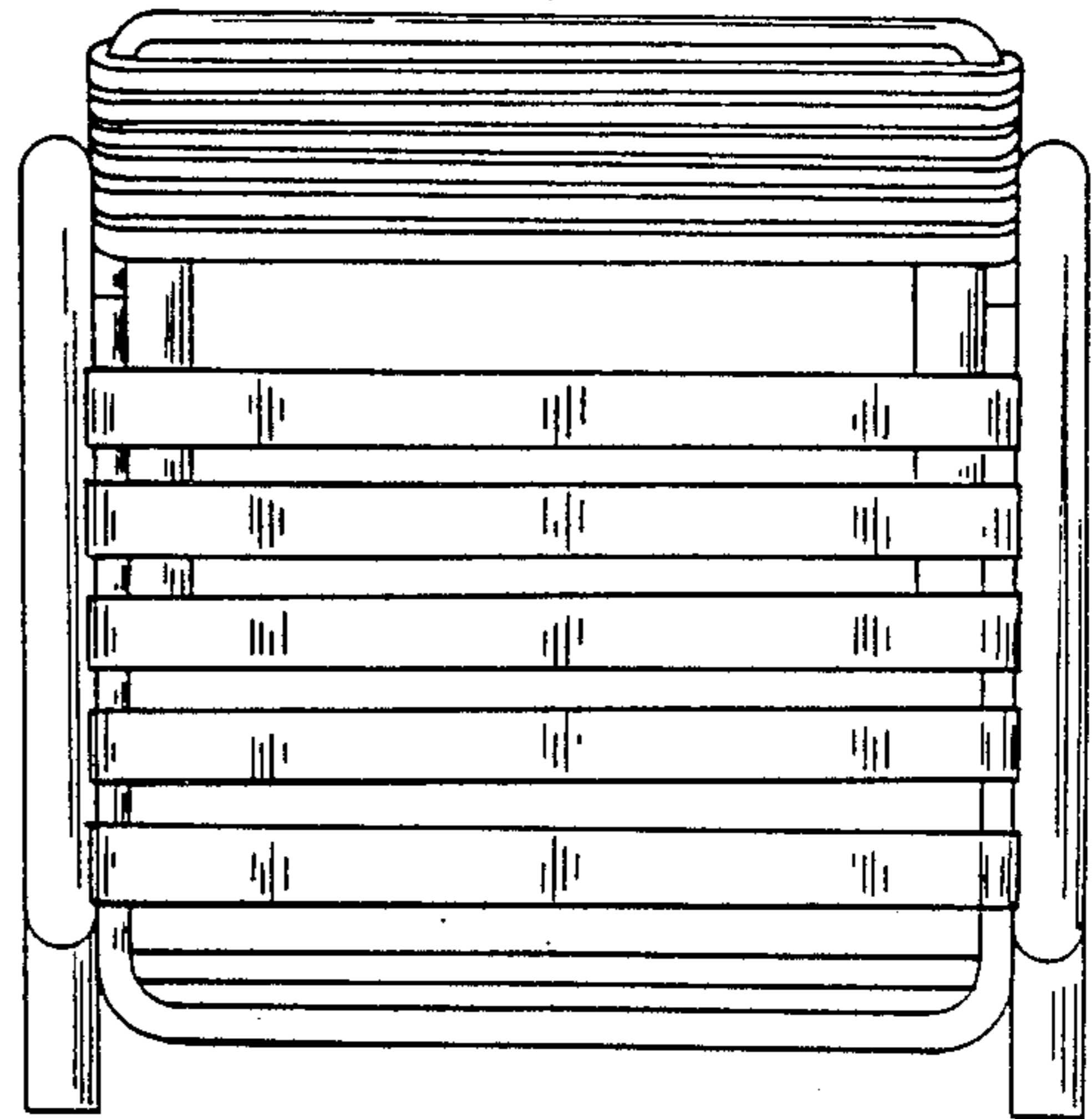

FIG. 21