

[54] TAPE RECORDER

[75] Inventors: Masayoshi Tsuchiya, Tokyo; Ichiro Hino, Yokohama, both of Japan

[73] Assignee: Sony Corporation, Tokyo, Japan

[**] Term: 14 Years

[21] Appl. No.: 315,042

[22] Filed: Feb. 24, 1989

[30] Foreign Application Priority Data

Aug. 26, 1988 [JP] Japan 63-33671

[52] U.S. Cl. D14/165; D14/163

[58] Field of Search D14/141, 160-168, D14/188-189, 191-192, 196, 199, 202, 299; 455/344, 350, 351; D21/111, 112, 113

[56] References Cited

U.S. PATENT DOCUMENTS

- D. 277,474 2/1985 Miura D14/165
- D. 290,843 7/1987 Murphy D14/168
- D. 292,222 10/1987 Stern D21/111
- D. 297,731 9/1988 Camens D14/165

OTHER PUBLICATIONS

Hong Kong Enterprise; 3/81; p. 203; bottom-Bropus Organ and Organ Radio.

Primary Examiner—Theodore M. Shooman
Attorney, Agent, or Firm—Lewis H. Eslinger; Jay H. Maioli

CLAIM

The ornamental design for a tape recorder, as shown and described.

DESCRIPTION

FIG. 1 is a top, front and left-side perspective view of a tape recorder, showing our new design;
 FIG. 2 is a top, front and left-side perspective view thereof, shown with cassette holder in the opened position;
 FIG. 3 is a front elevational view thereof;
 FIG. 4 is a rear elevational view thereof;
 FIG. 5 is a left-side elevational view thereof;
 FIG. 6 is a right-side elevational view thereof;
 FIG. 7 is a top plan view thereof; and
 FIG. 8 is a bottom plan view thereof.

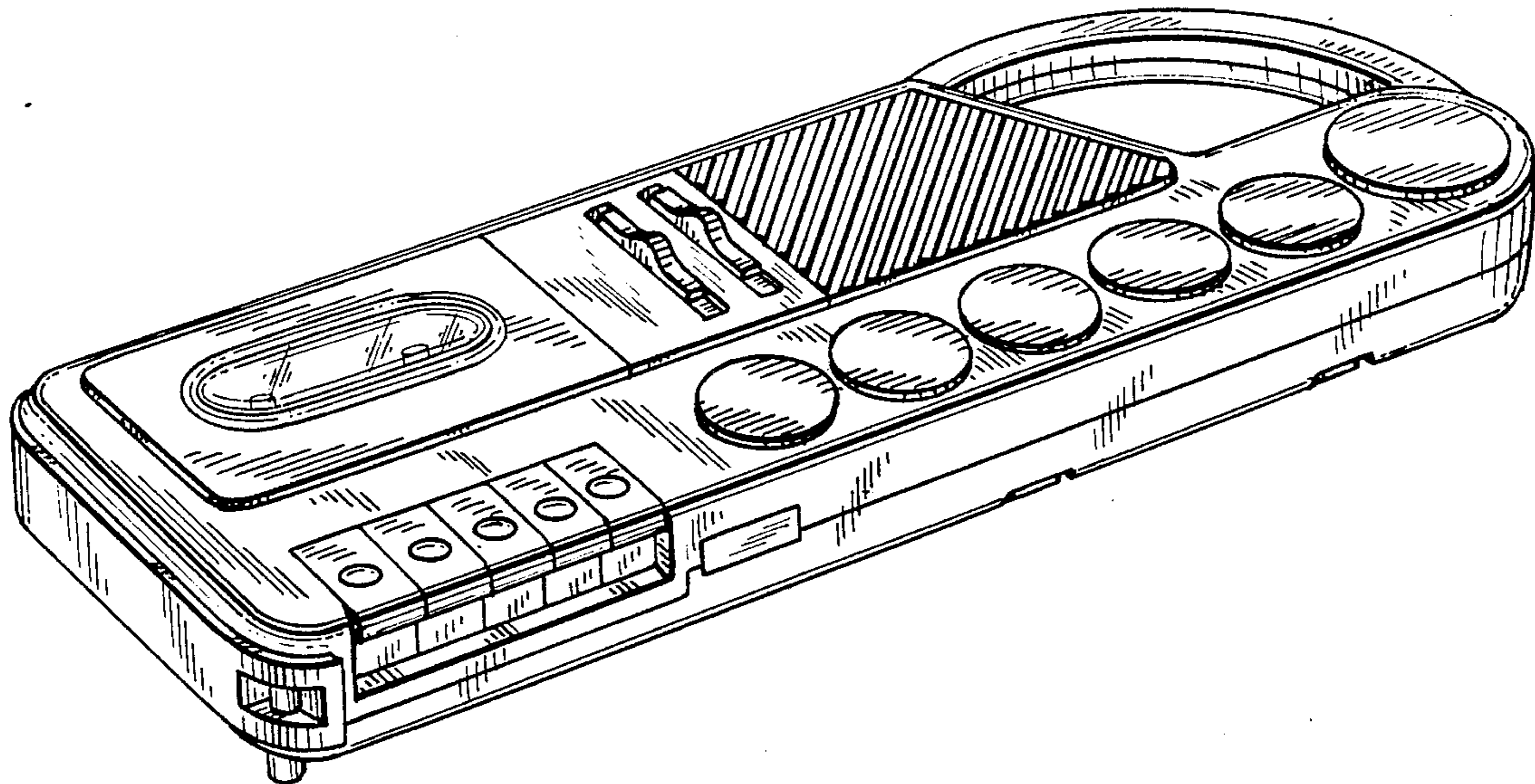

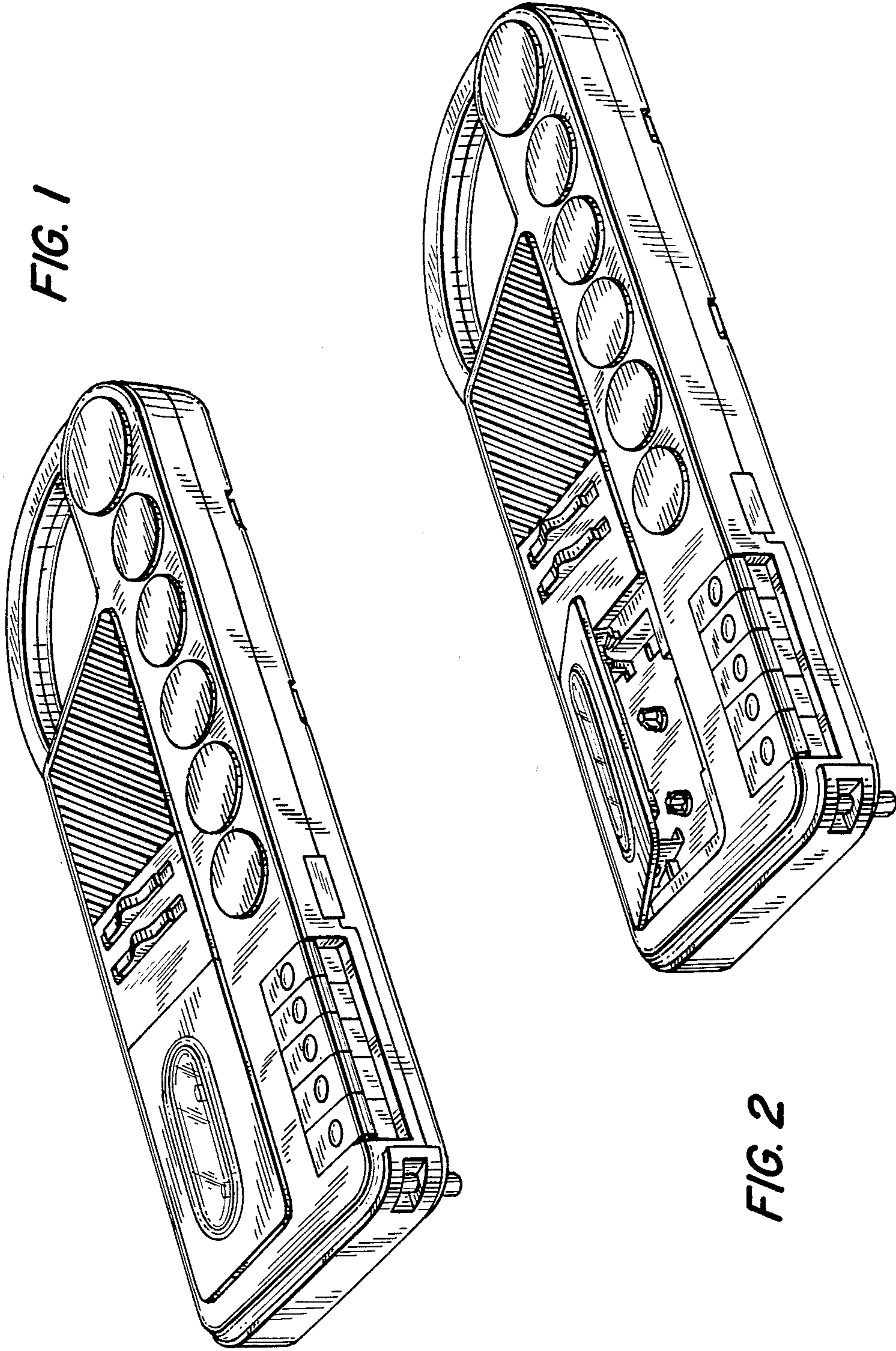

FIG. 1

FIG. 2

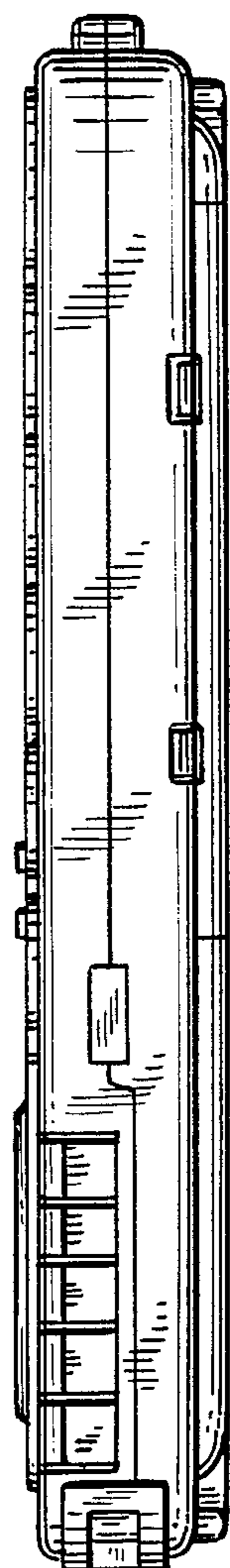

FIG. 3

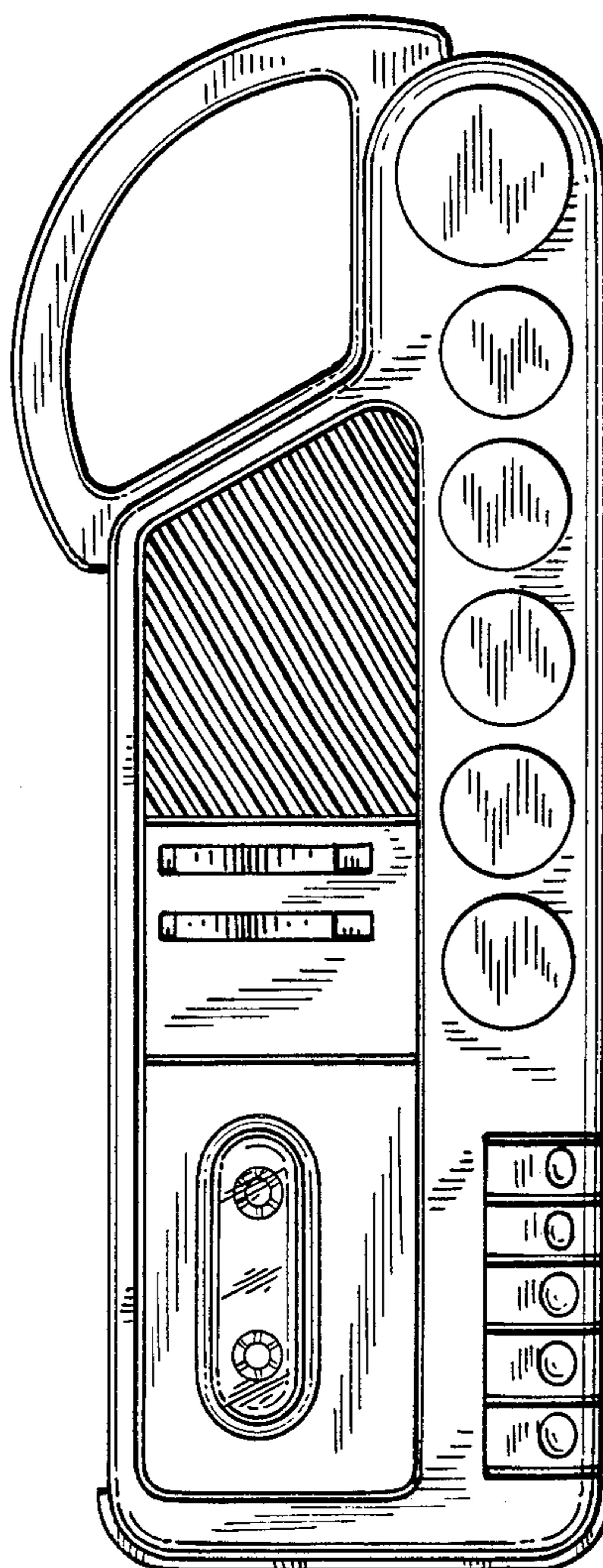

FIG. 7

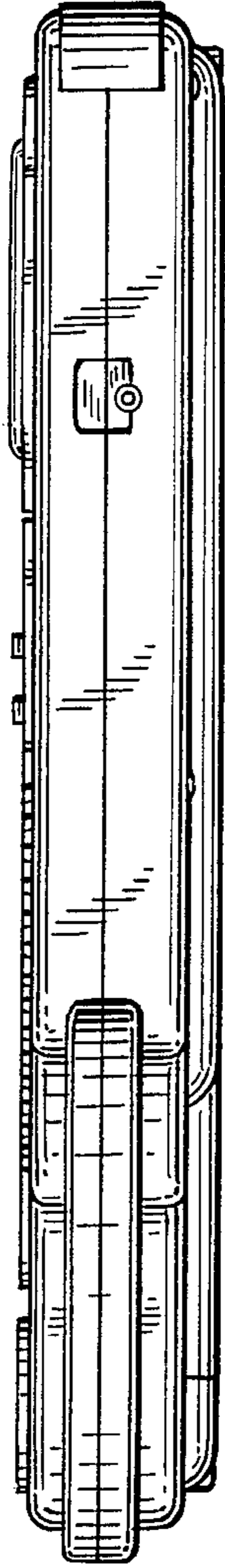

FIG. 4

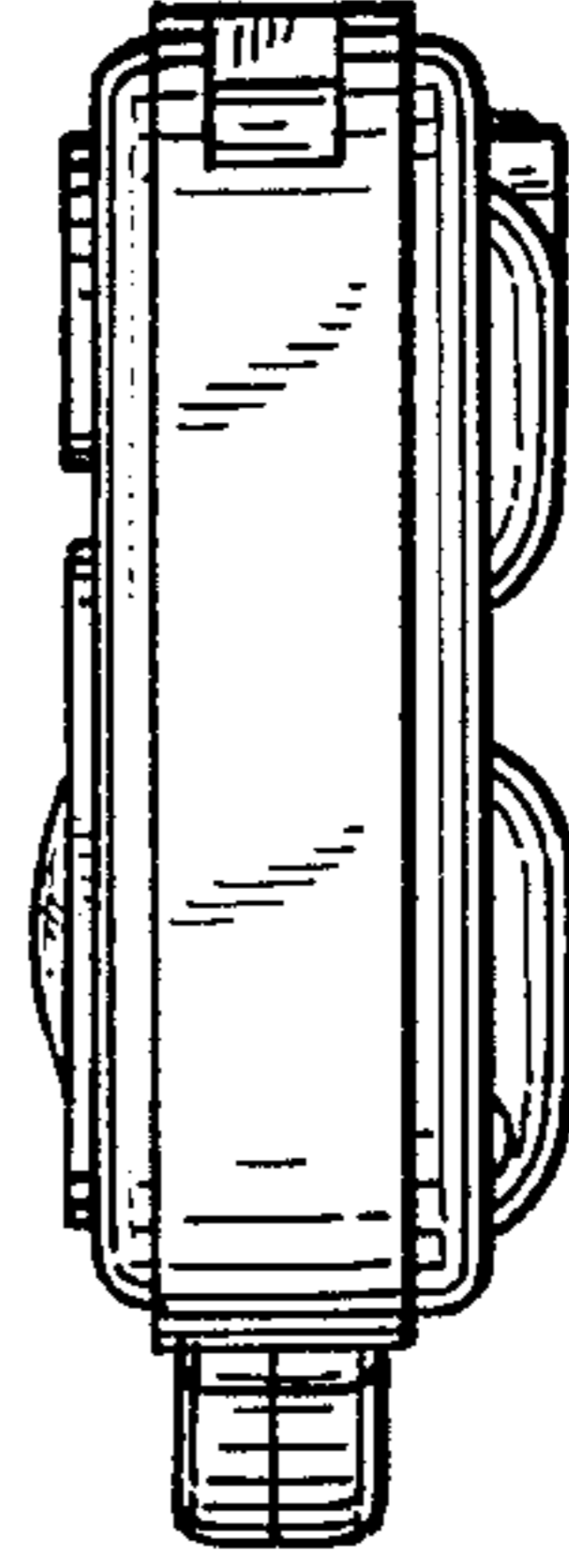

FIG. 5

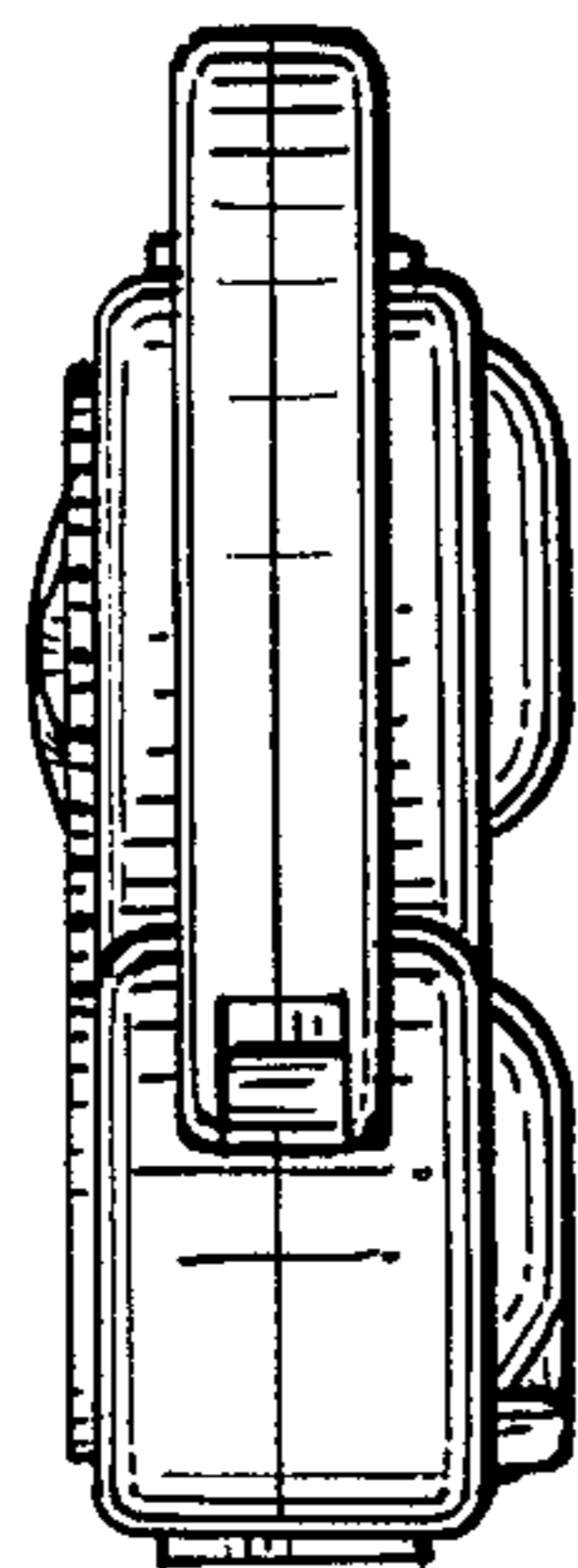

FIG. 6

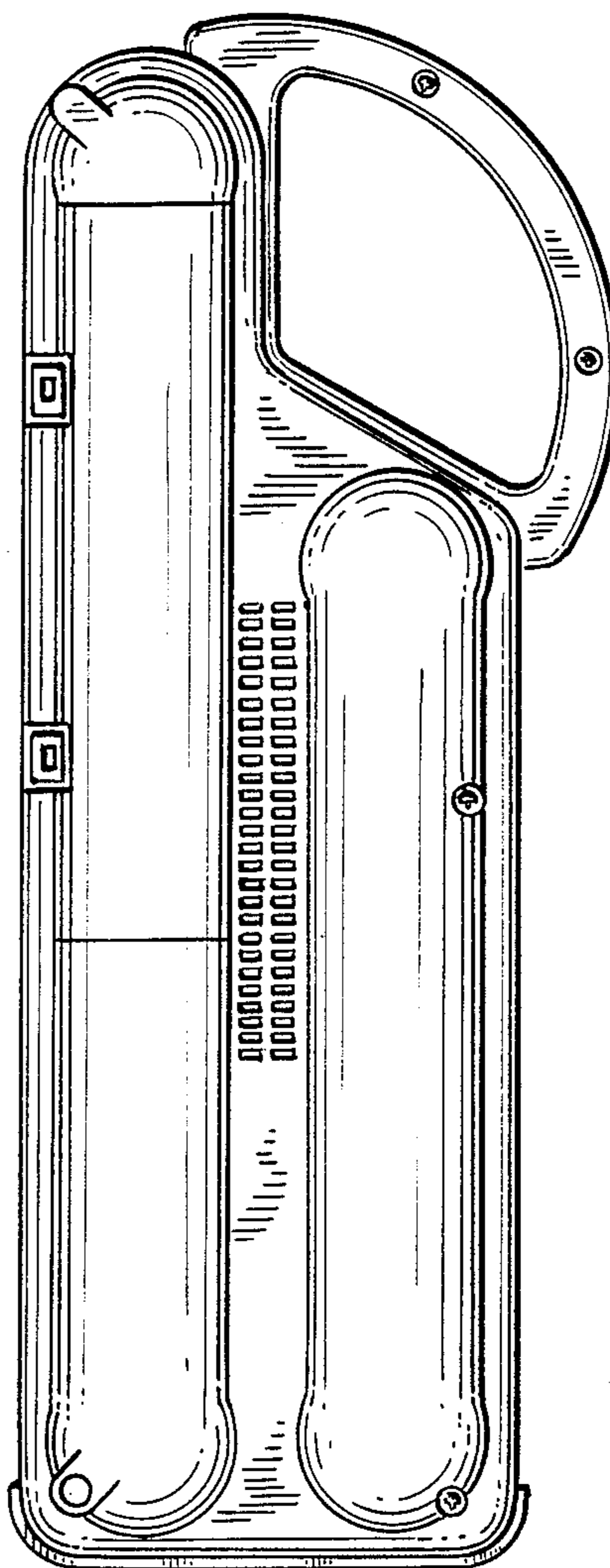

FIG. 8