

[54] **AUTOMOBILE**

[75] **Inventors: Humirou Yoshikawa; Tsuyoshi Nishimura; Syuhei Ueda, all of Saitama, Japan**

[73] **Assignee: Honda Giken Kogyo Kabushiki Kaisha, Tokyo, Japan**

[**] **Term: 14 Years**

[21] **Appl. No.: 62,824**

[22] **Filed: Jun. 15, 1987**

[30] **Foreign Application Priority Data**

Dec. 15, 1986 [JP] Japan 61-49567

[52] **U.S. Cl. D12/92**

[58] **Field of Search D12/91, 92; 296/185**

[56] **References Cited**

U.S. PATENT DOCUMENTS

D. 282,918 3/1986 Yamashita et al. D12/92

D. 299,325 1/1989 Oshika et al. D12/92

OTHER PUBLICATIONS

Motor Trend, 8/85, p. 51, Honda Accord, bottom of page.

Motor Trend, 3/86, p. 91, Acura Legend, bottom right side of page.

Motor Trend, 9/86, p. 25, Nissan Pulsar, top right side of page.

Road & Track, 5/86, p. 36, Subaru Sedan, bottom left side of page.

Road & Track, 11/86, p. 185, Toyota Corolla, top of page.

Primary Examiner—James M. Gandy

Attorney, Agent, or Firm—Lyon & Lyon

[57] **CLAIM**

The ornamental design for an automobile, as shown.

DESCRIPTION

FIG. 1 is a top plan view of the automobile showing our new design;

FIG. 2 is a right side elevation view thereof;

FIG. 3 is a front elevation view thereof;

FIG. 4 is a rear elevation view thereof;

FIG. 5 is a left side elevation view thereof.

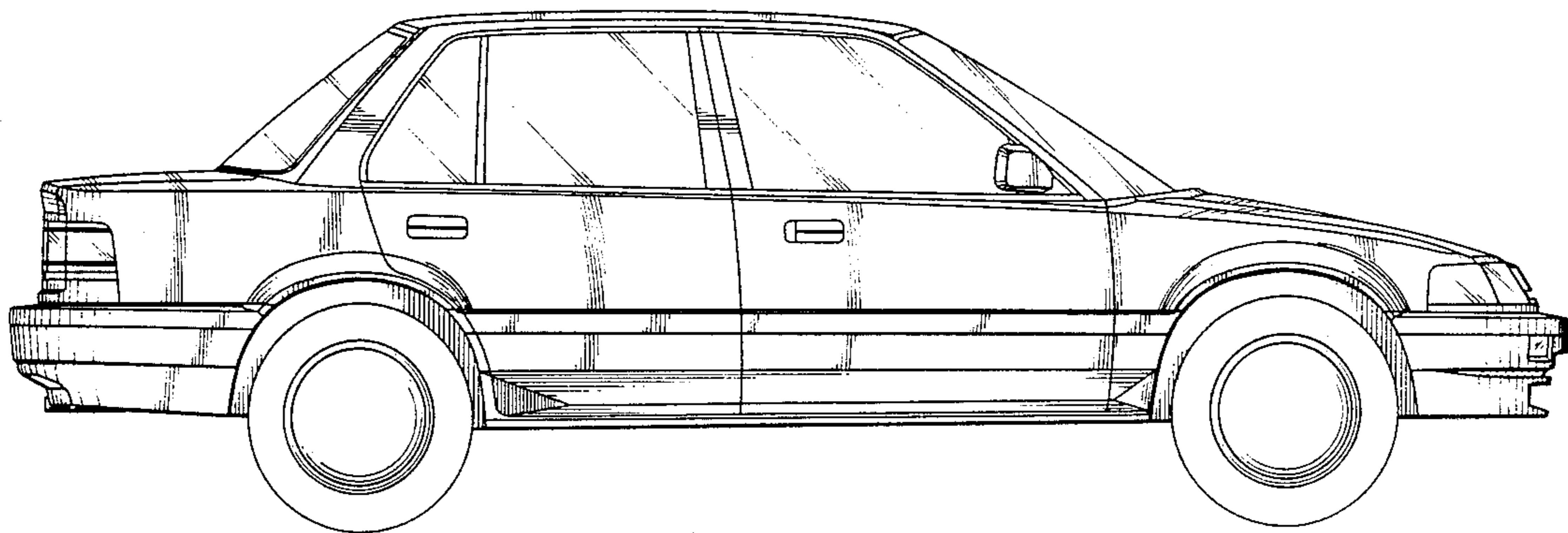

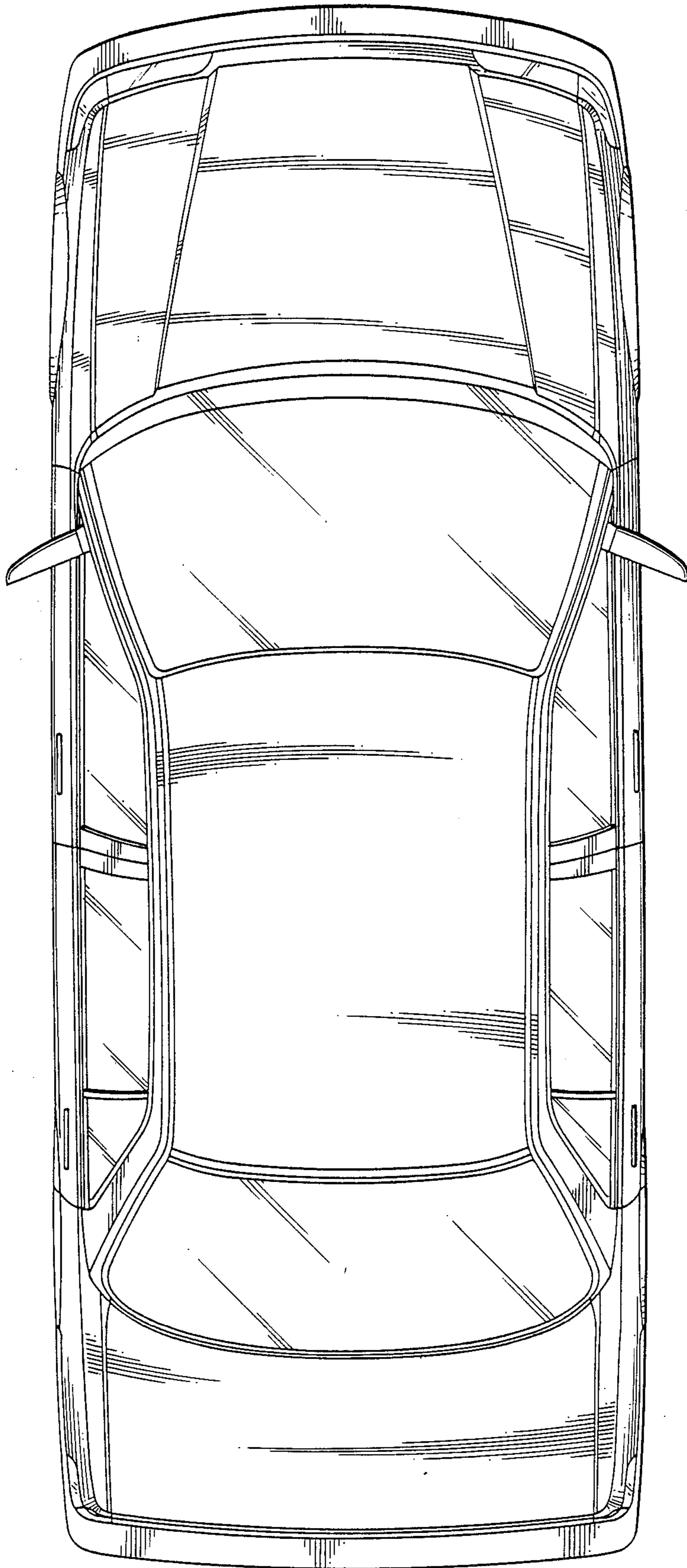

FIG. 1.

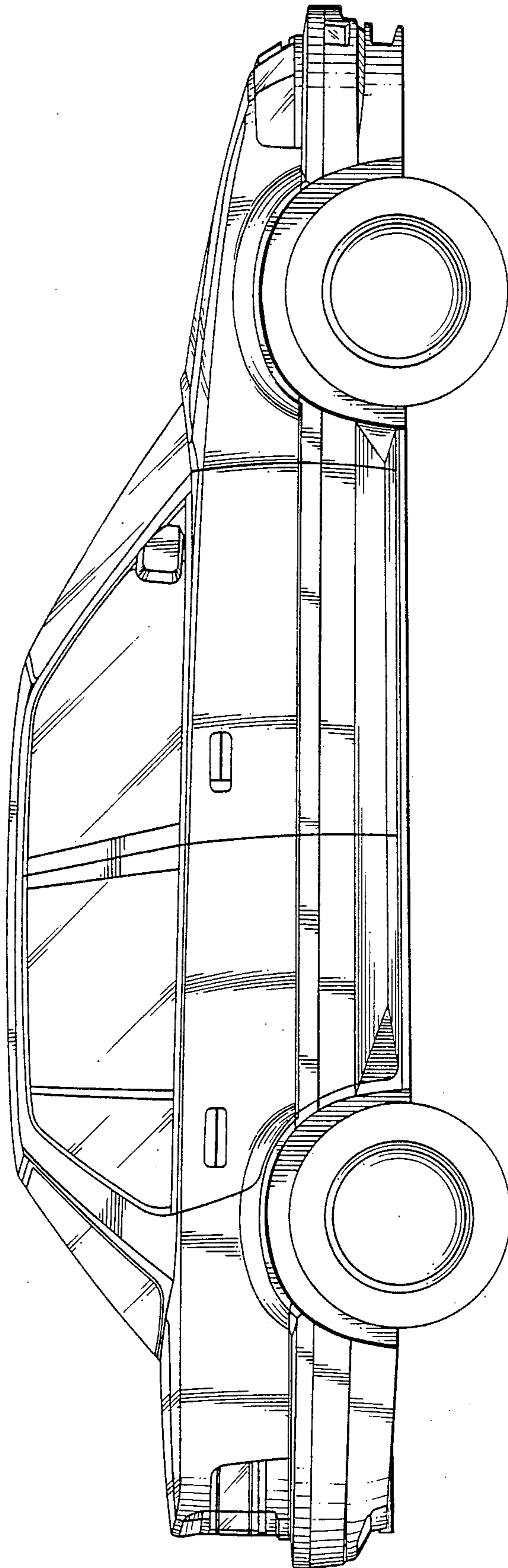

FIG. 2.

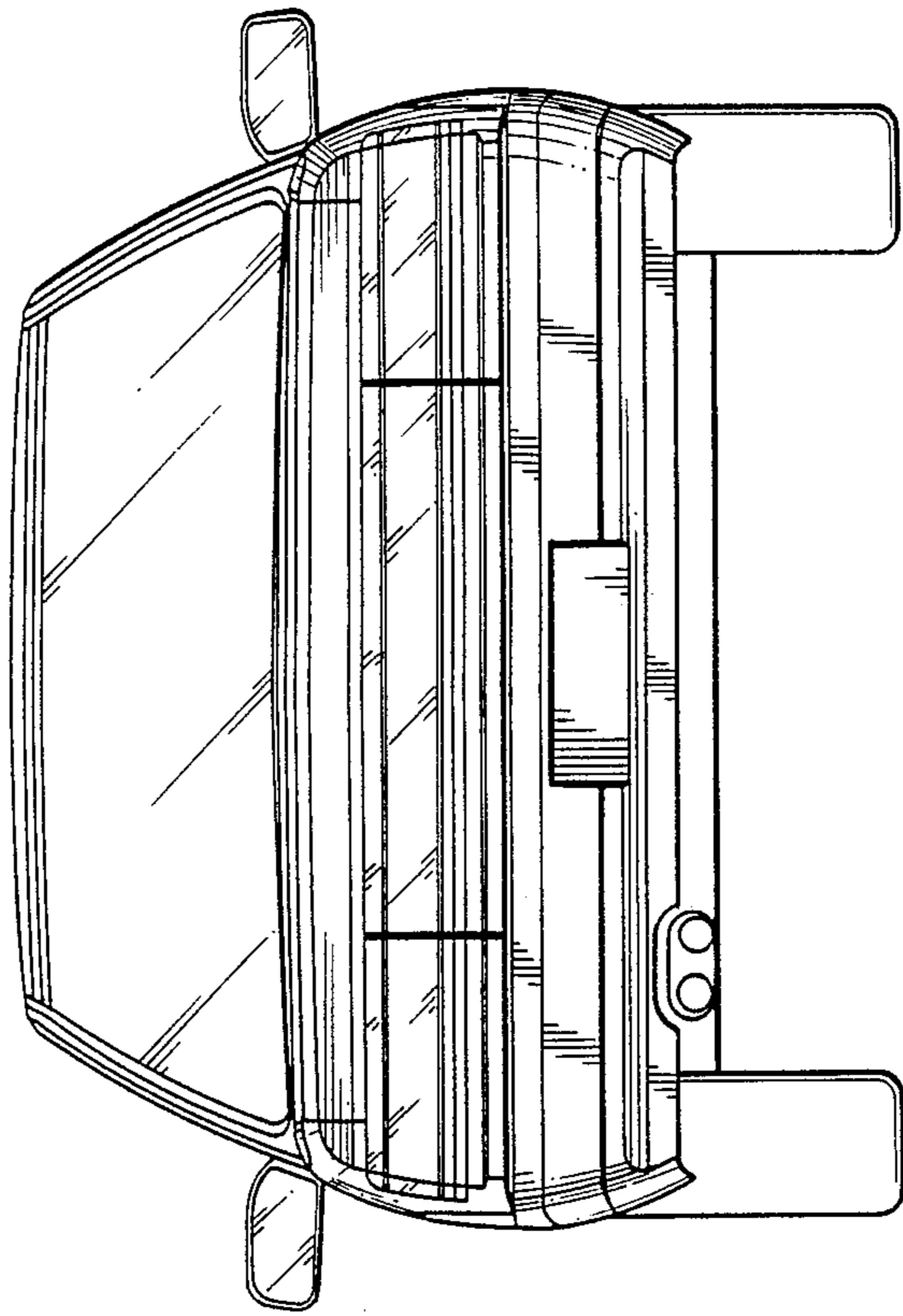

FIG. 4.

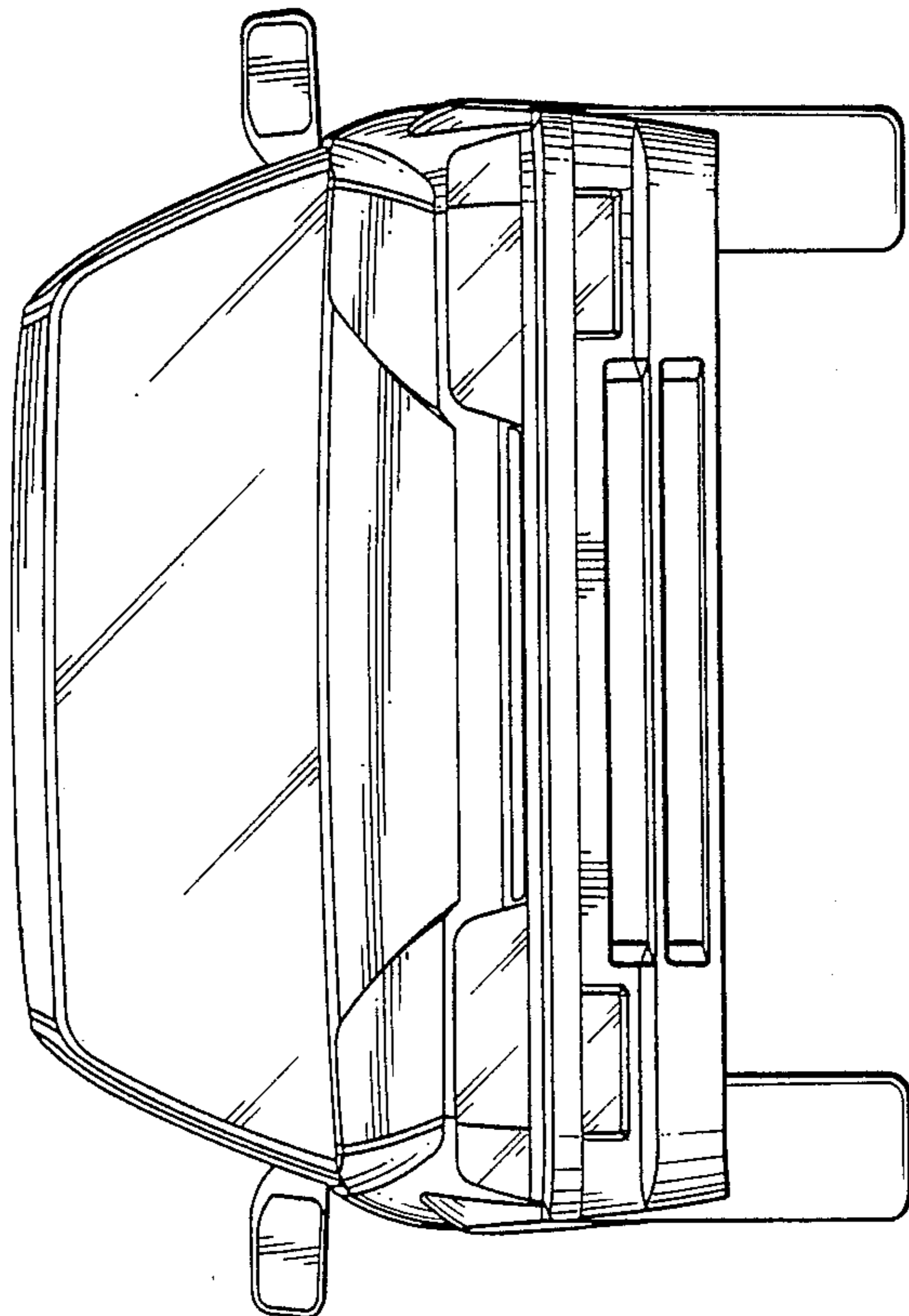

FIG. 3.

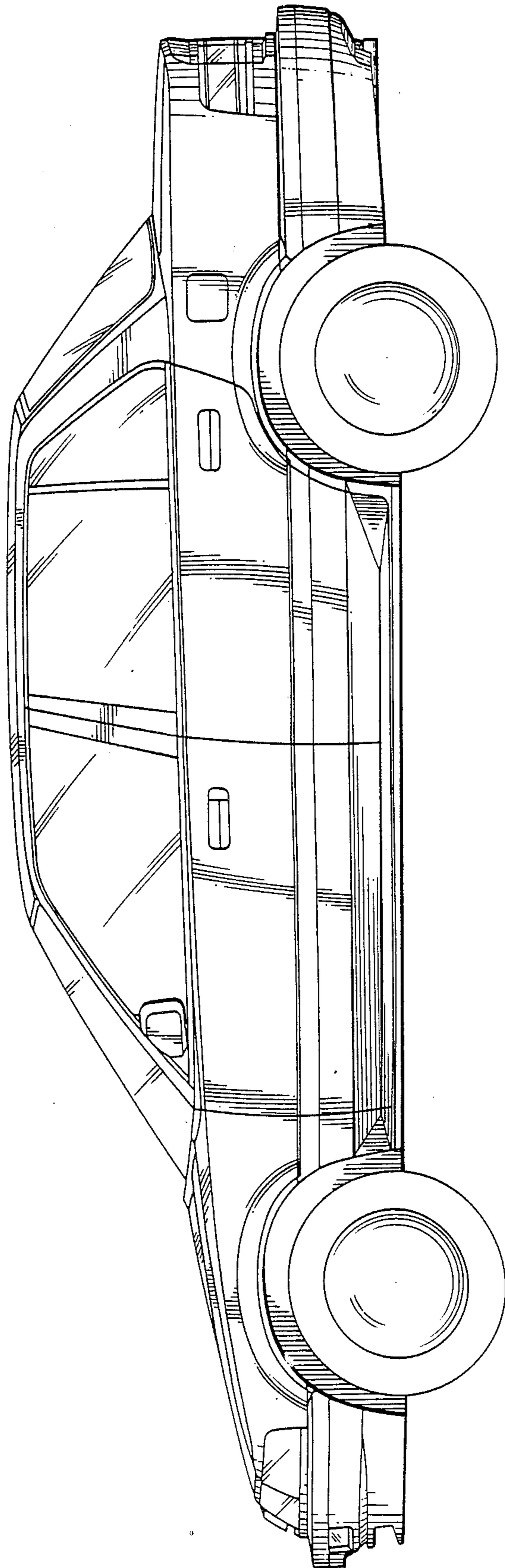

FIG. 5 .

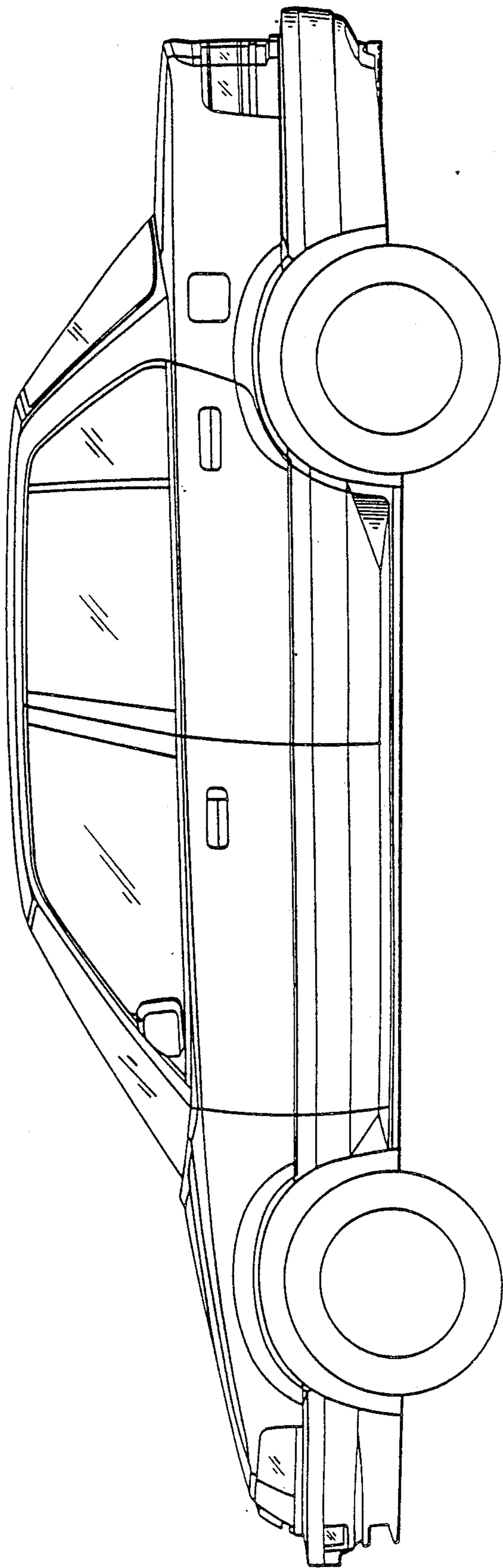

FIG. 6.