

[54] **TOY PUPPET STAGE**

[76] **Inventor: Frederick H. Kroll, 11289 Piping Rock Dr., Boynton Beach, Fla. 33437**

[\*\*] **Term: 14 Years**

[21] **Appl. No.: 360,714**

[22] **Filed: Jun. 2, 1989**

[52] **U.S. Cl. .... D21/114**

[58] **Field of Search ..... D21/59, 114; 446/82, 446/84, 83; D25/161**

[56] **References Cited**

**U.S. PATENT DOCUMENTS**

D. 240,151 6/1976 Stubbmann ..... D21/114

D. 247,721 4/1978 Wax ..... D21/114

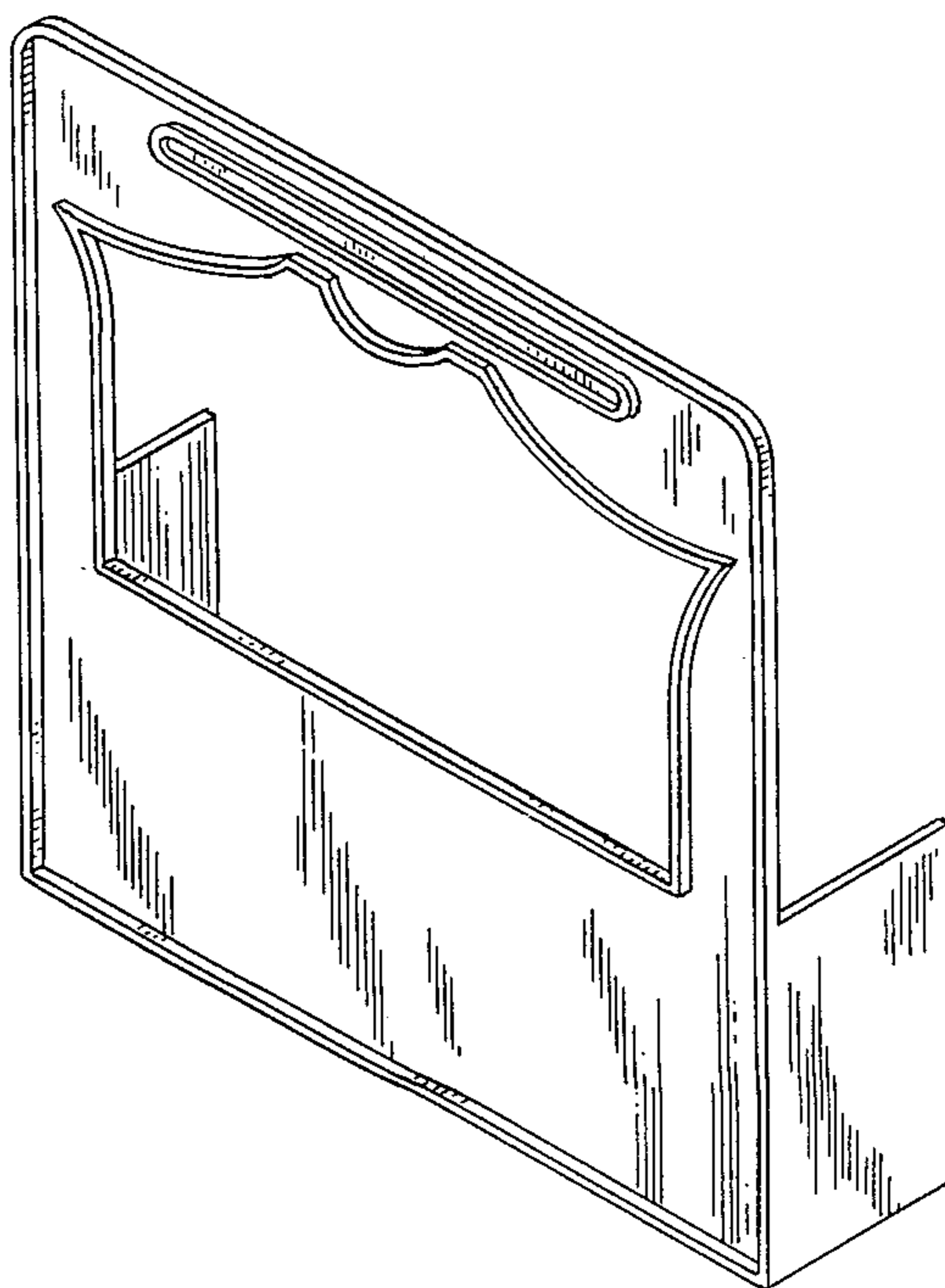
*Primary Examiner*—Charles A. Rademaker  
*Attorney, Agent, or Firm*—Harry W. Barron

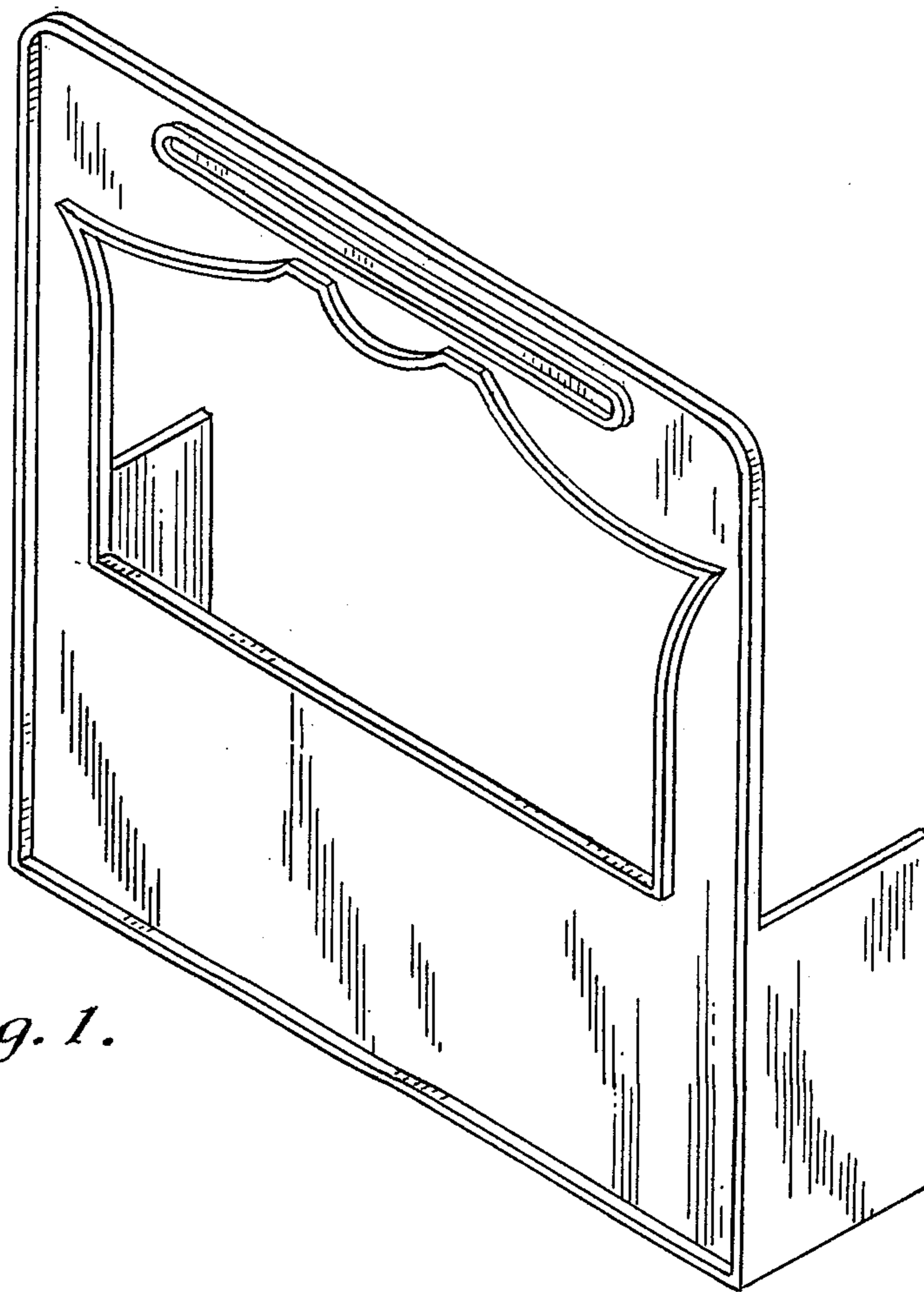
[57] **CLAIM**

The ornamental design for a toy puppet stage, as shown and described.

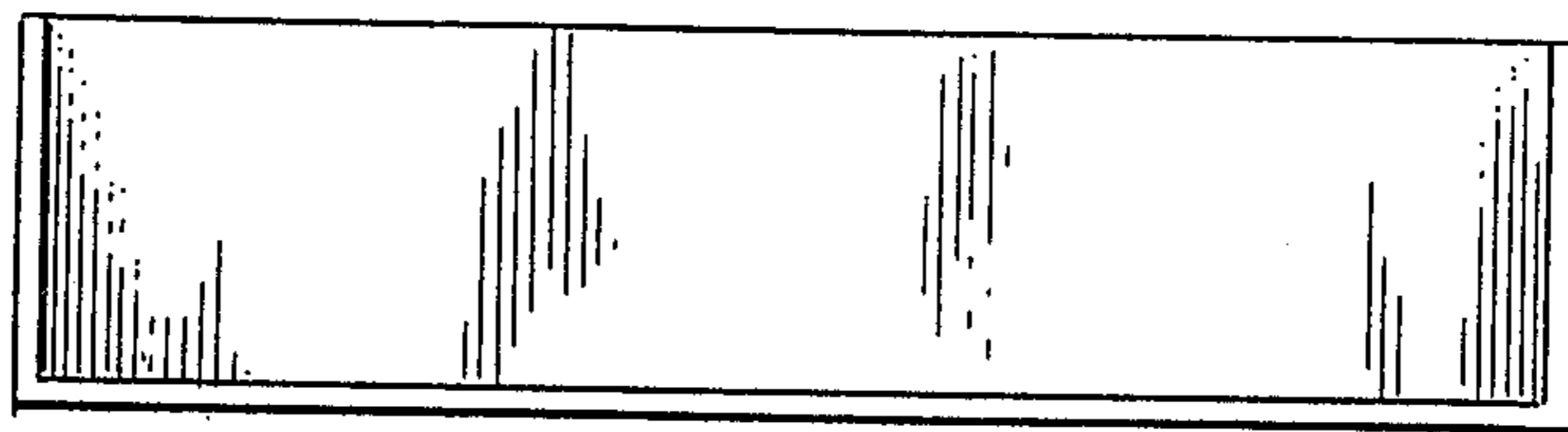
**DESCRIPTION**

FIG. 1 is a front perspective view of a toy puppet stage showing my new design;  
FIG. 2 is a front elevational view thereof;  
FIG. 3 is a left side elevational view thereof;  
FIG. 4 is a rear elevational view thereof;  
FIG. 5 is a right side elevational view thereof;  
FIG. 6 is a top plan view thereof; and,  
FIG. 7 is a bottom plan view thereof.

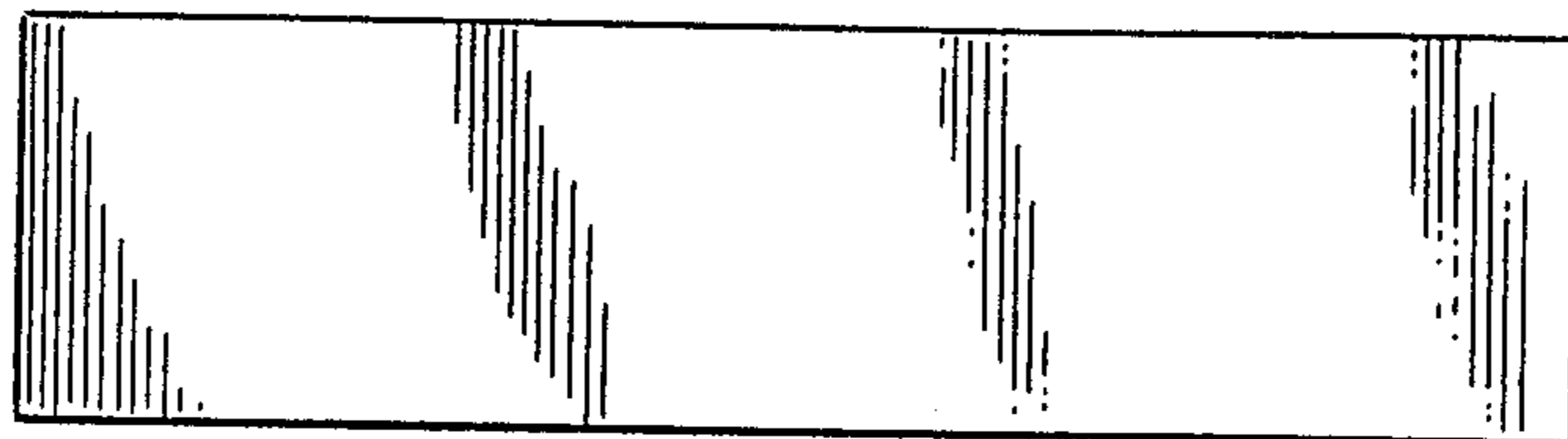




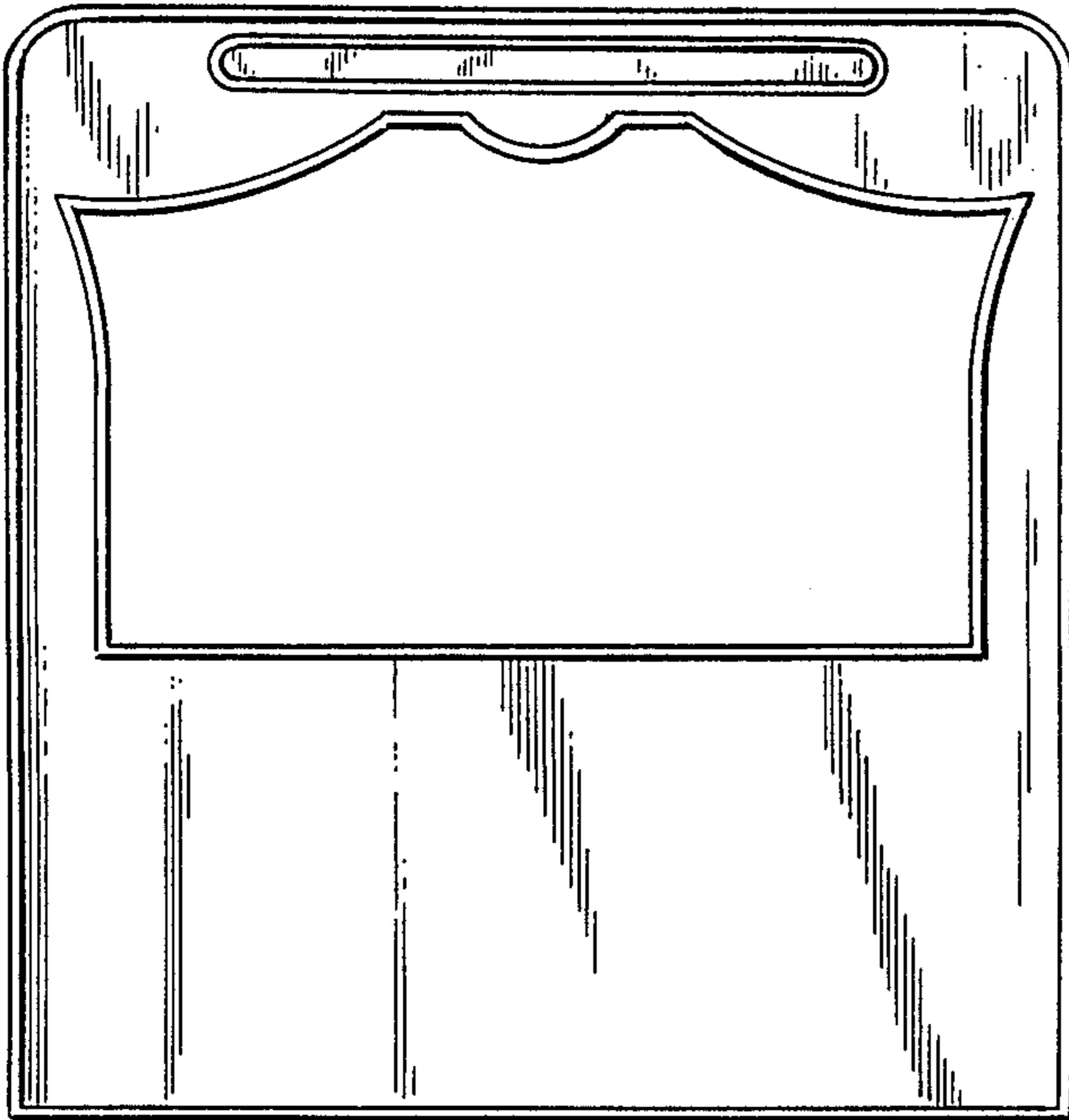
*Fig. 1.*



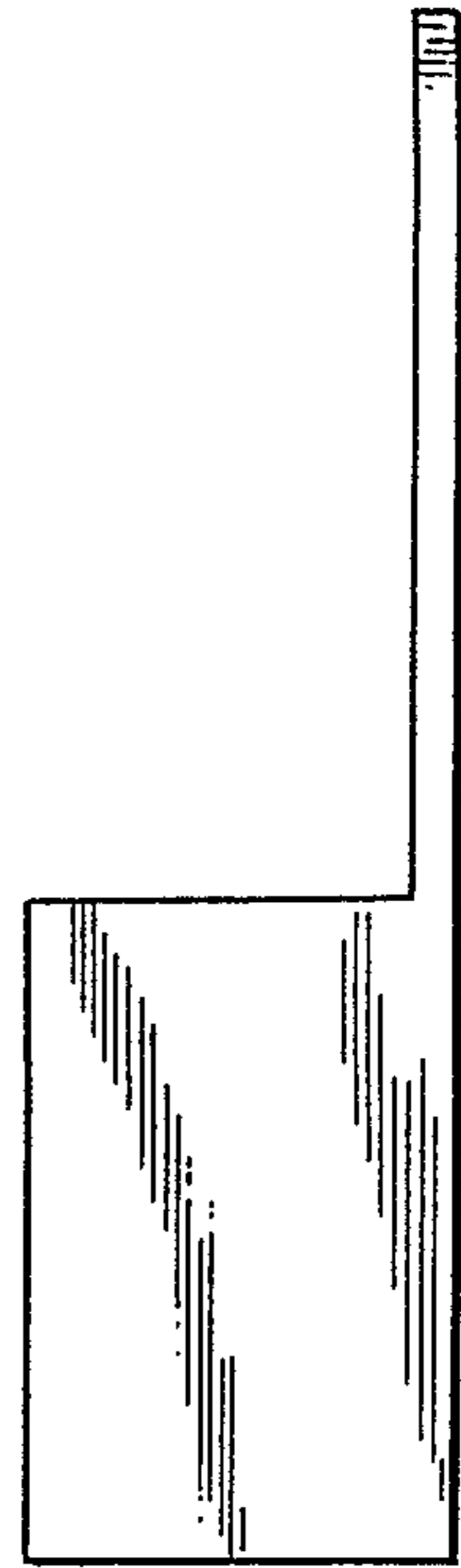
*Fig. 6.*



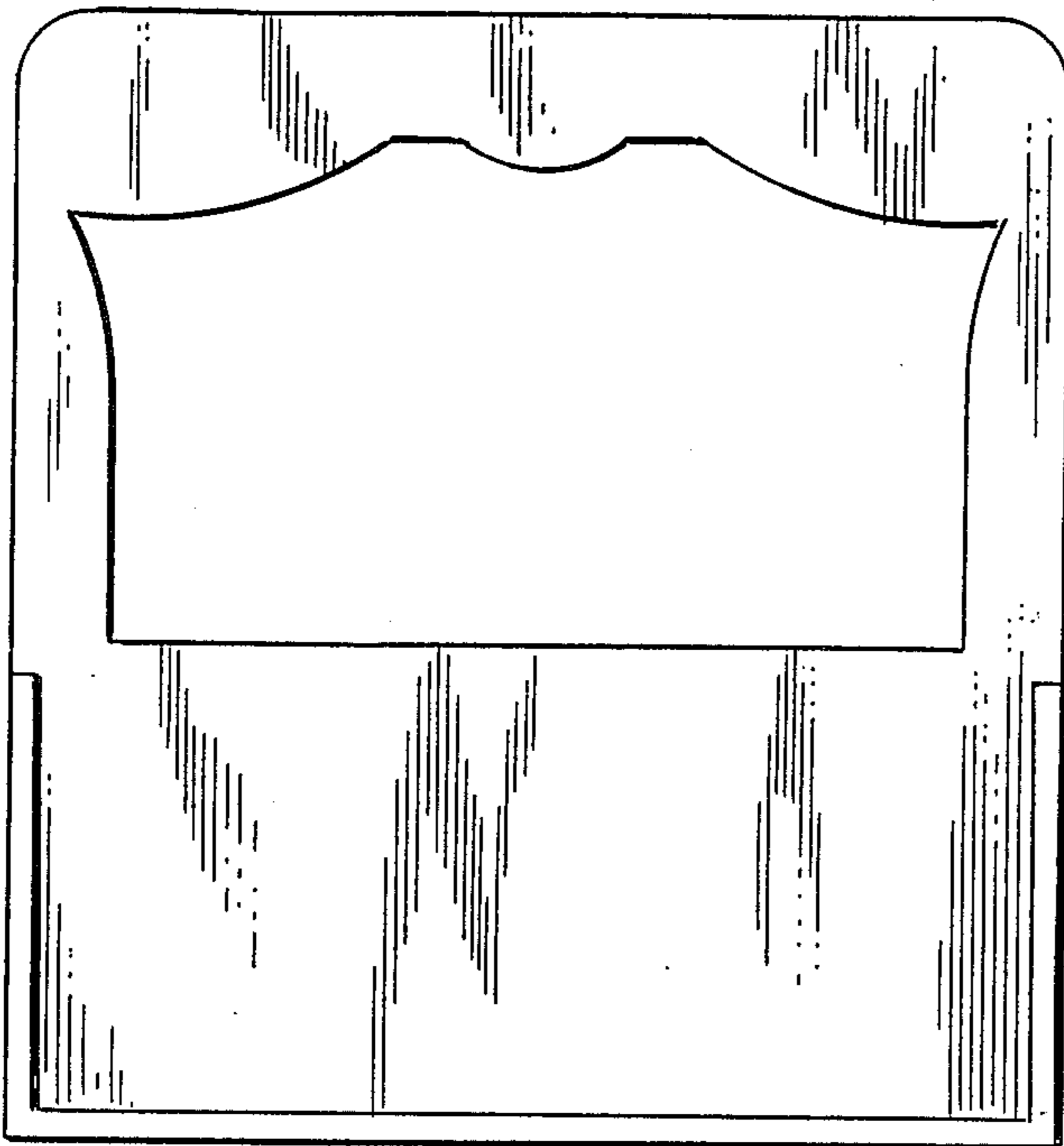
*Fig. 7.*



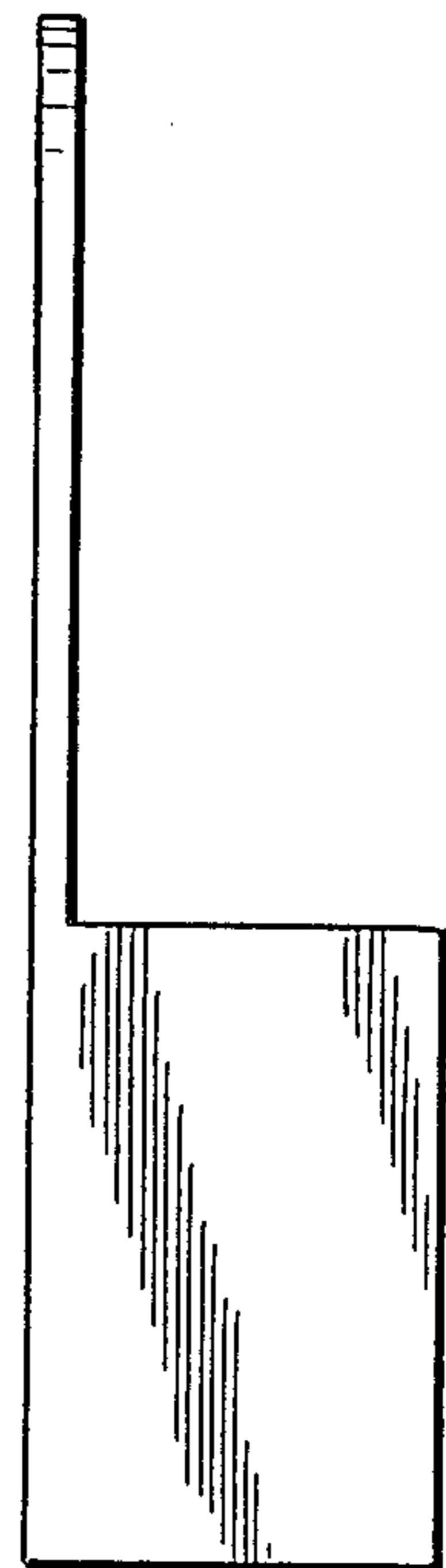
*Fig. 2.*



*Fig. 3.*



*Fig. 4.*



*Fig. 5.*