

[54] CHAIR

[75] Inventors: Gary Lee; Melvin Hamilton, both of Chicago, Ill.

[73] Assignee: Helikon Furniture Company, Taftville, Conn.

[\*\*] Term: 14 Years

[21] Appl. No.: 30,817

[22] Filed: Mar. 25, 1987

[52] U.S. Cl. .... D6/380; D6/370

[58] Field of Search ..... D6/334, 370, 379, 380

[56] References Cited

U.S. PATENT DOCUMENTS

D. 194,031	11/1962	Jensen et al. ....	D6/379
D. 202,035	8/1965	Cox et al. ....	D6/380
D. 279,331	6/1985	Griffith ....	D6/379
D. 298,190	10/1988	Komai et al. ....	D6/379

Primary Examiner—Bruce W. Dunkins  
Assistant Examiner—Ann Hunt

Attorney, Agent, or Firm—Darby & Darby

[57] CLAIM

The ornamental design for a chair, as shown and described.

DESCRIPTION

FIG. 1 is a front perspective view of the chair, on a reduced scale, showing our new design;  
 FIG. 2 is a front elevational view;  
 FIG. 3 is a top plan view;  
 FIG. 4 is a left side elevational view, the right side elevational view being a mirror image thereof;  
 FIG. 5 is a bottom plan view;  
 FIG. 6 is a rear elevational view thereof;  
 FIG. 7 is a front perspective view of a second embodiment of the chair, on a reduced scale, showing our new design.  
 FIG. 8 is a front elevational view;  
 FIG. 9 is a top plan view;  
 FIG. 10 is a left side elevational view, the right side elevational view being a mirror image thereof;  
 FIG. 11 is a bottom plan view; and  
 FIG. 12 is a rear elevational view thereof.

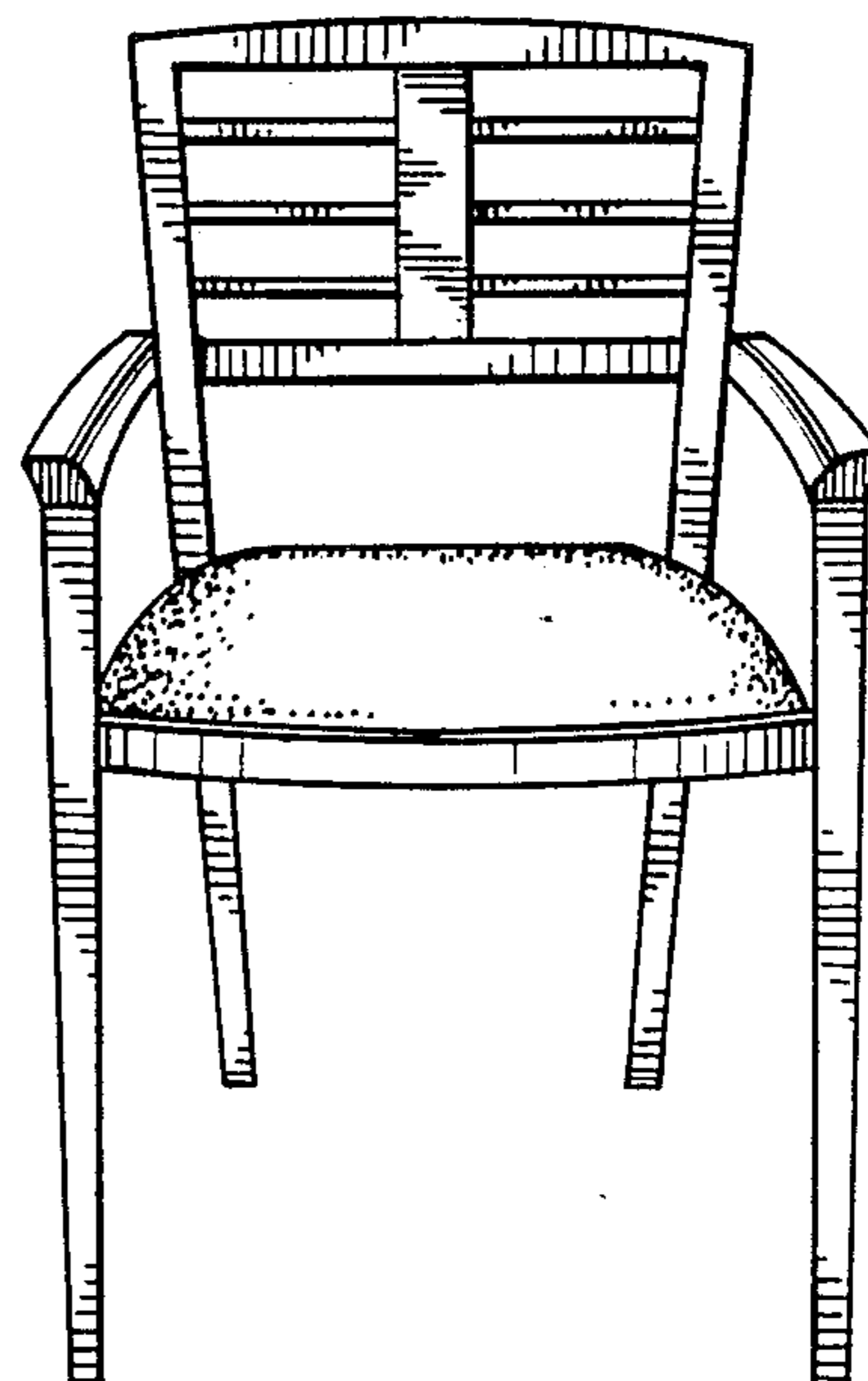
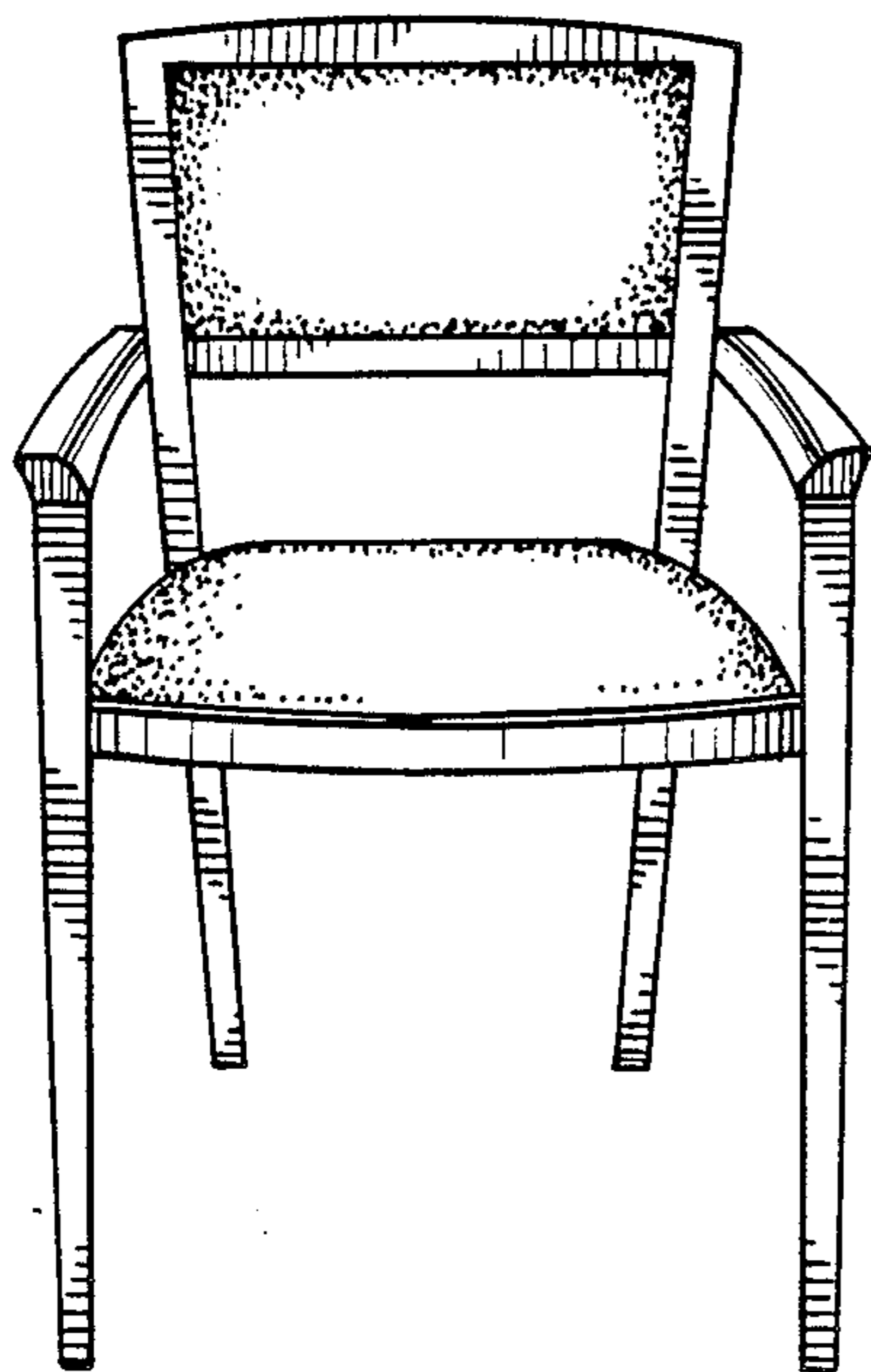

FIG. 1

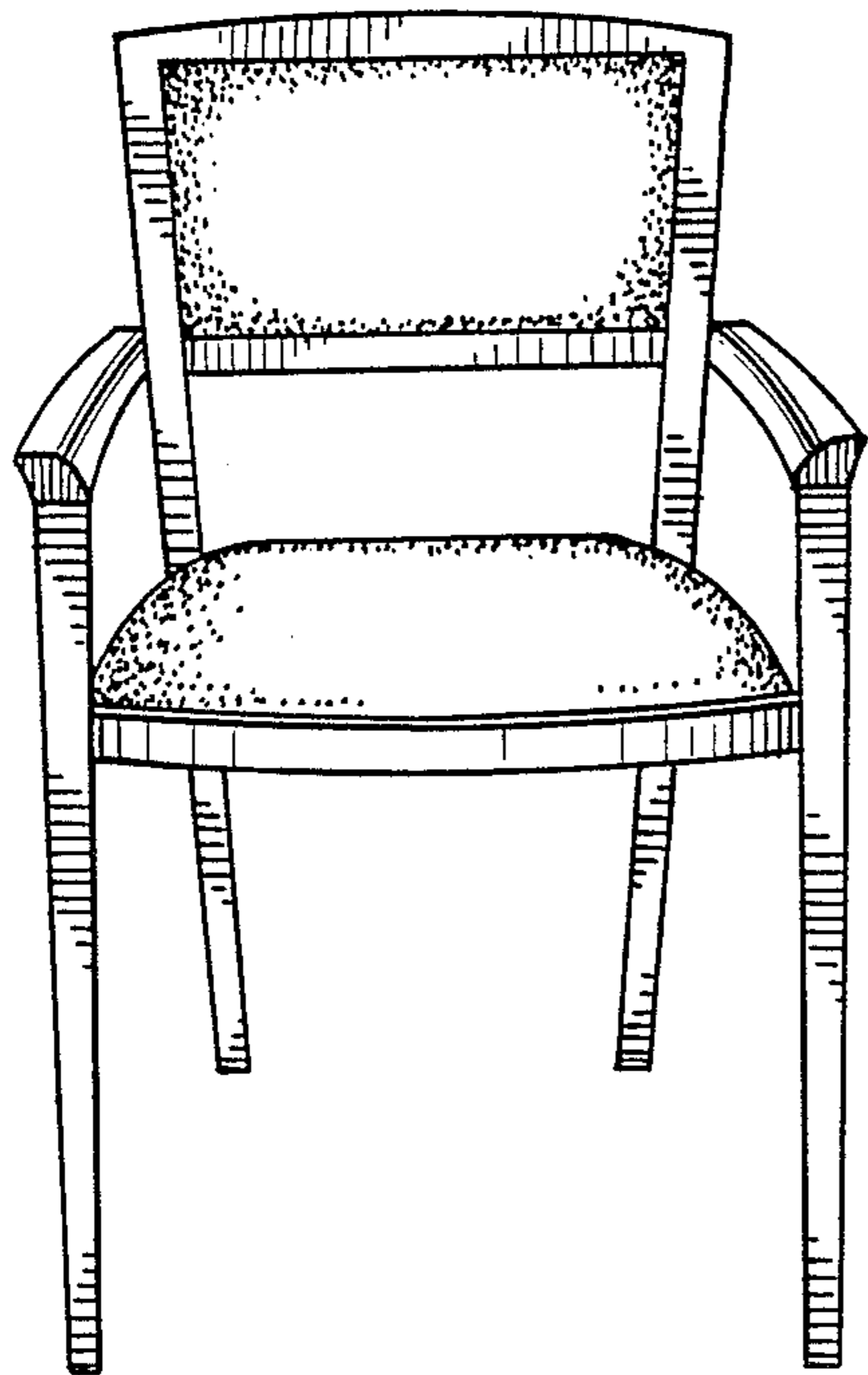

FIG. 2

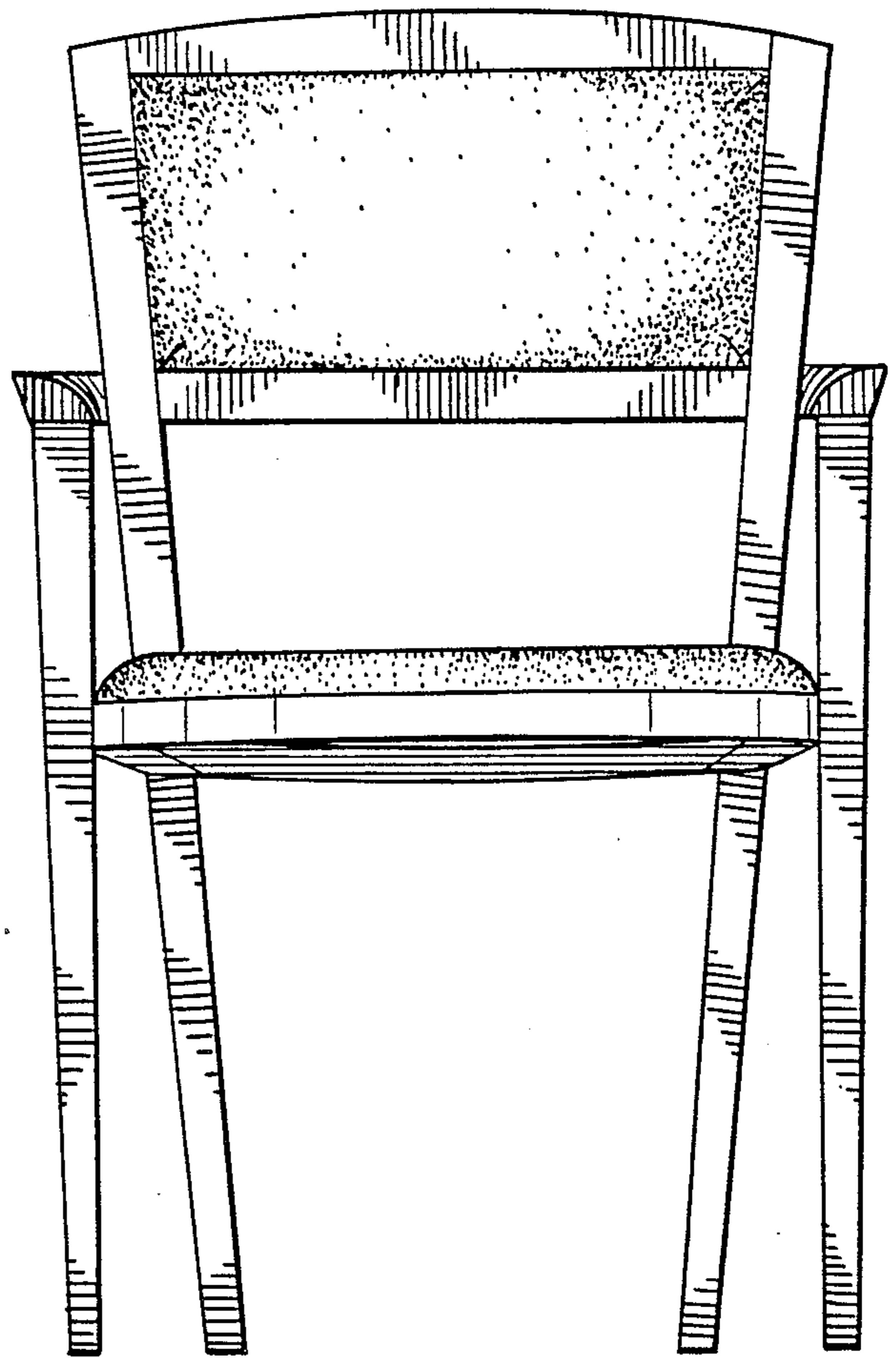

FIG. 3

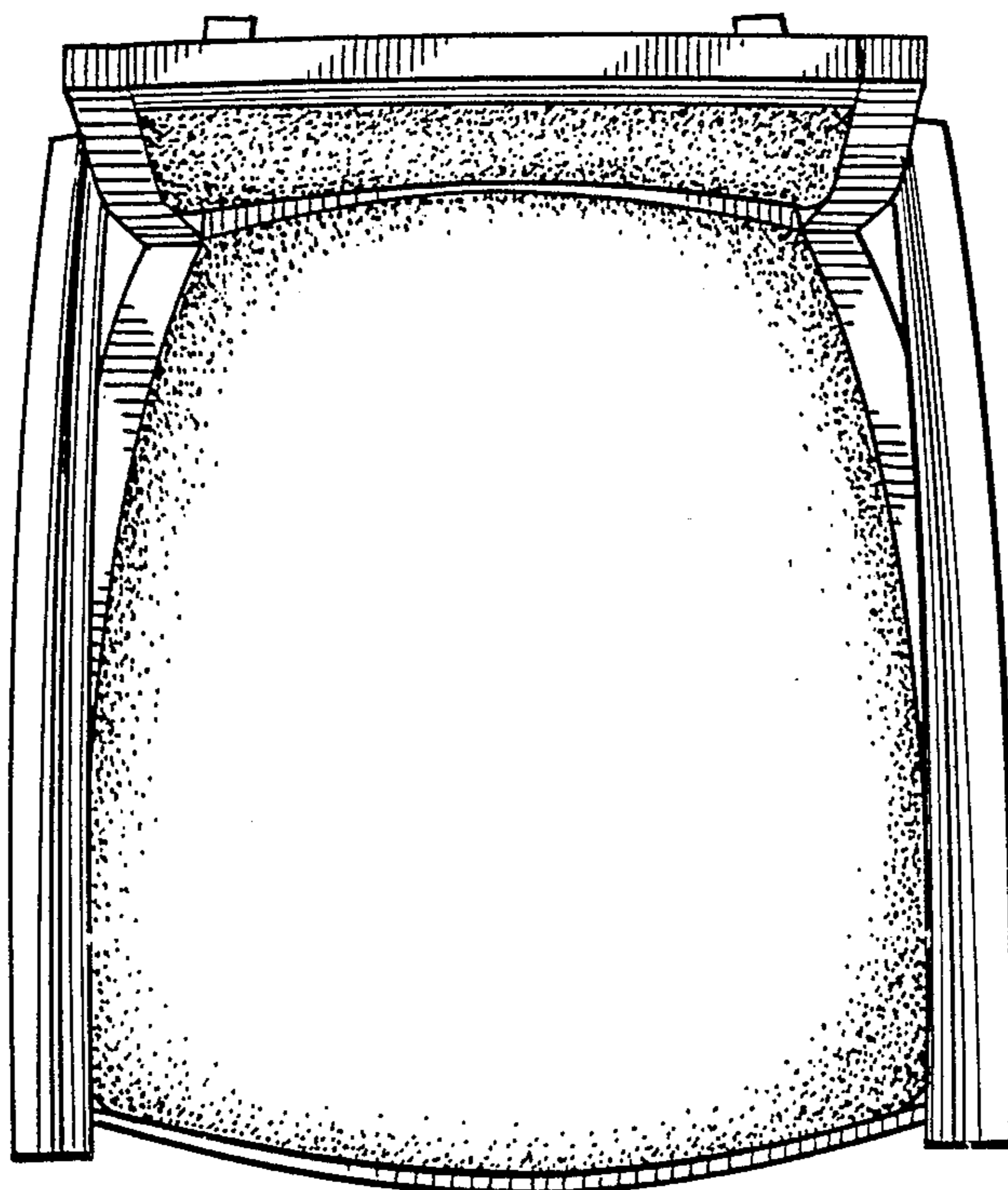

FIG. 4

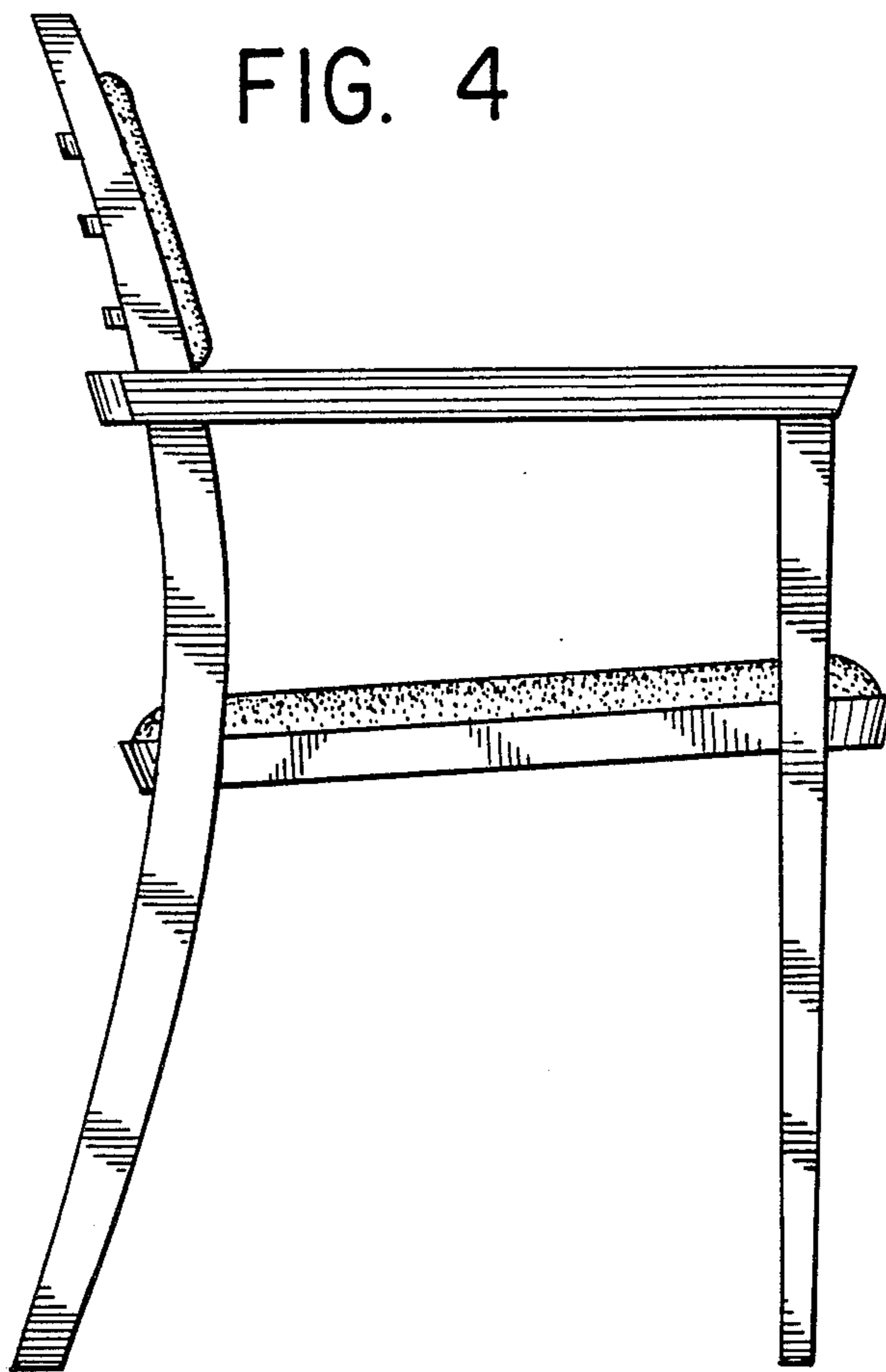

FIG. 5

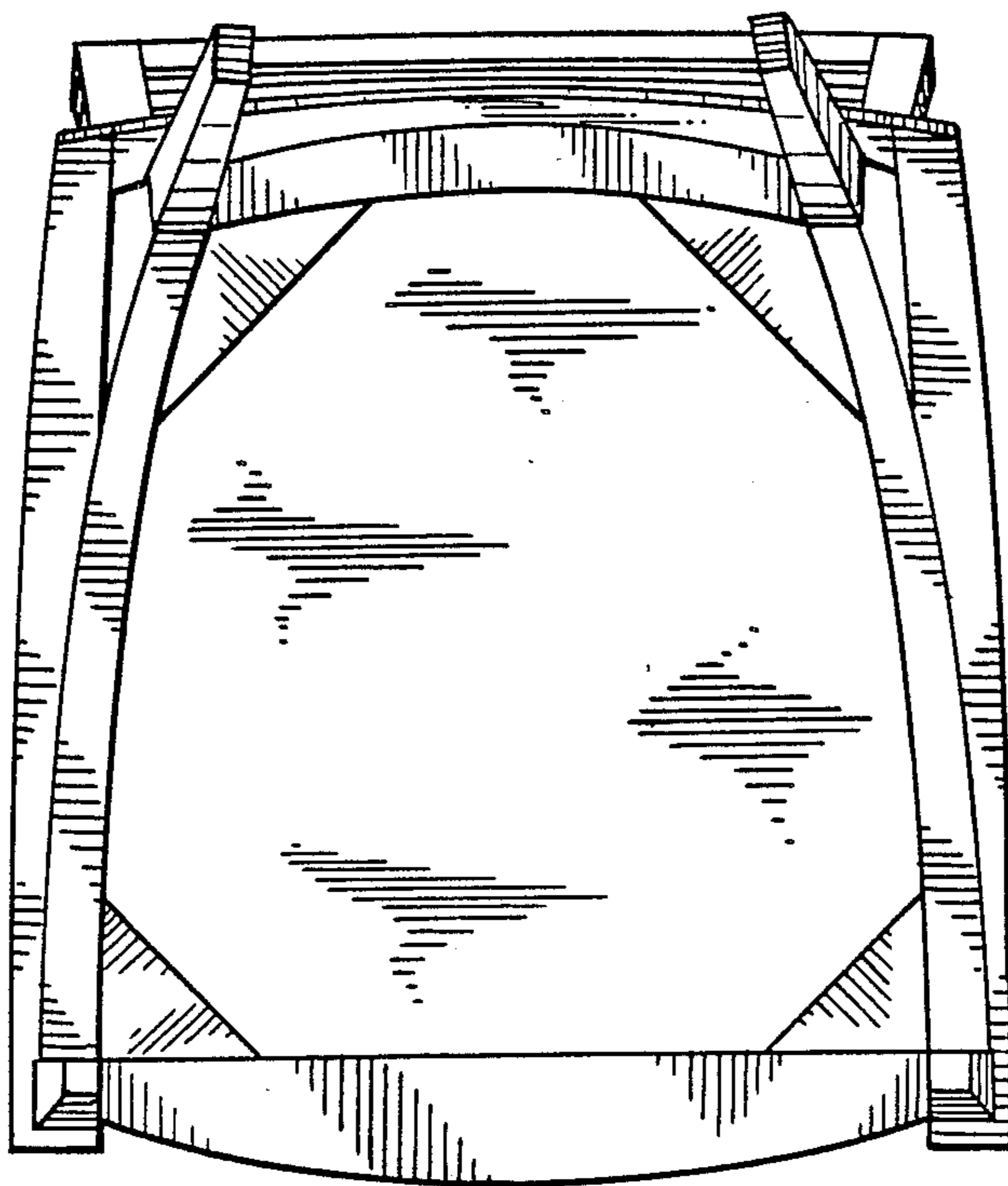

FIG. 7

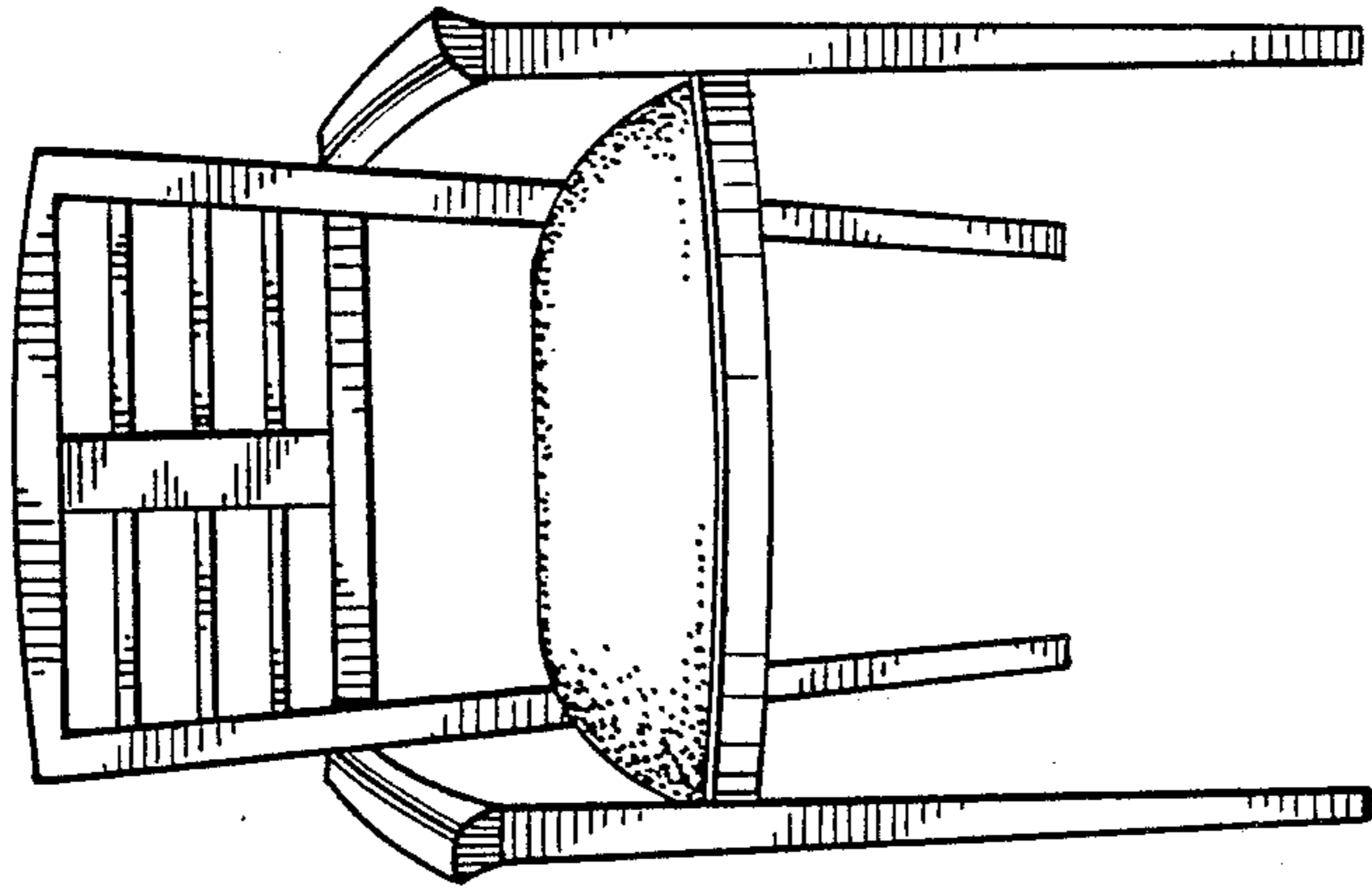

FIG. 6

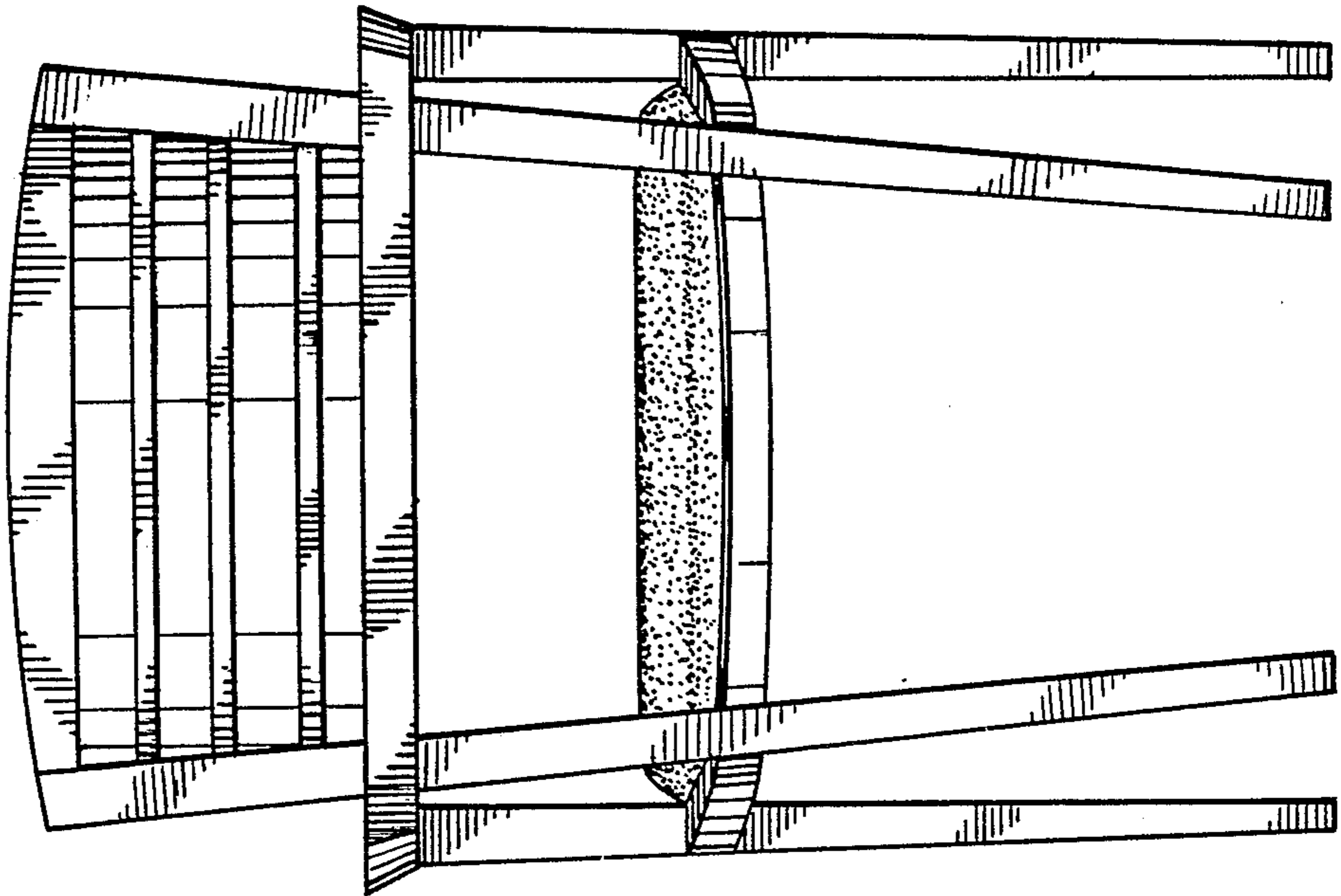



FIG. 8

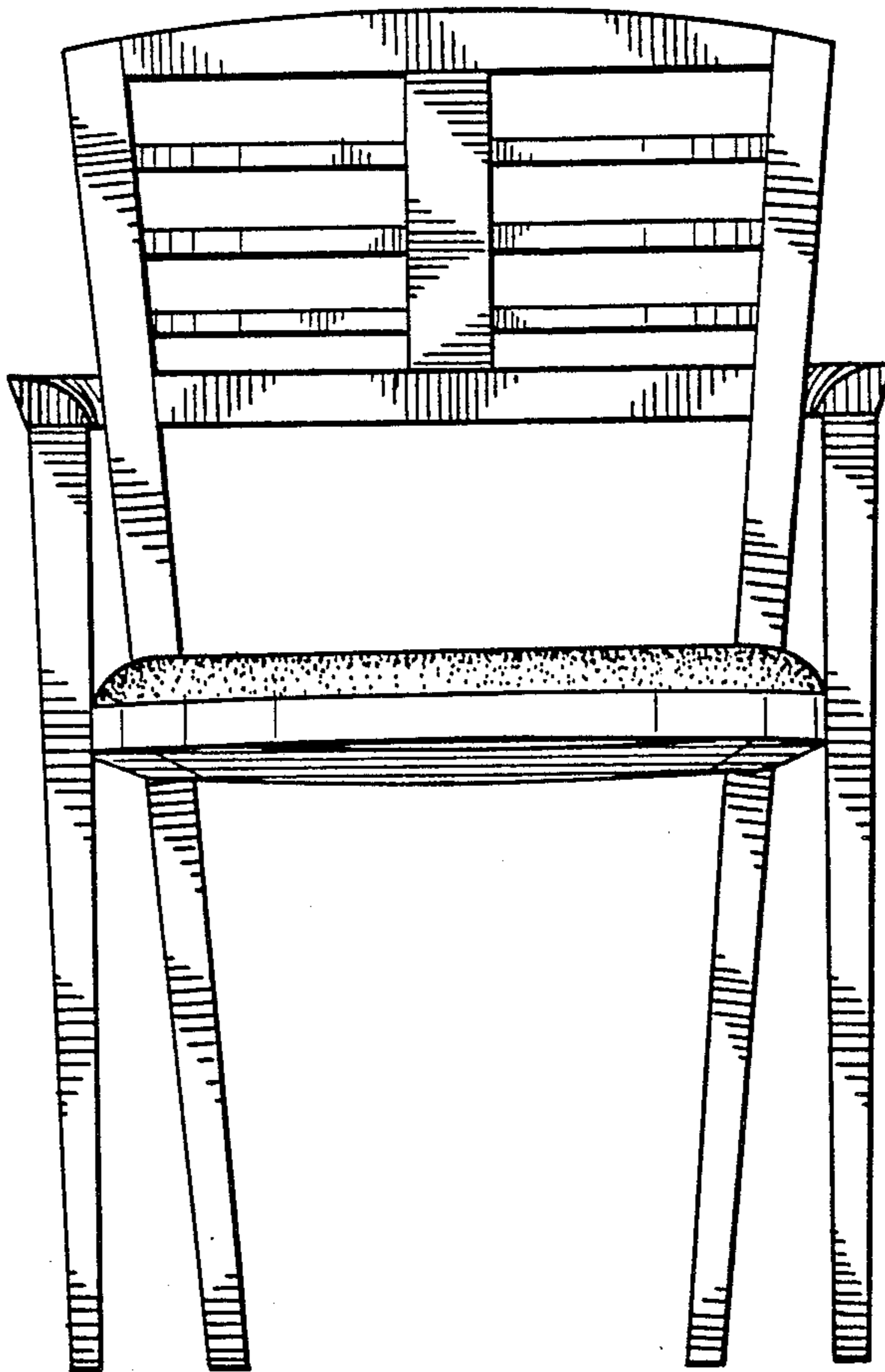

FIG. 9

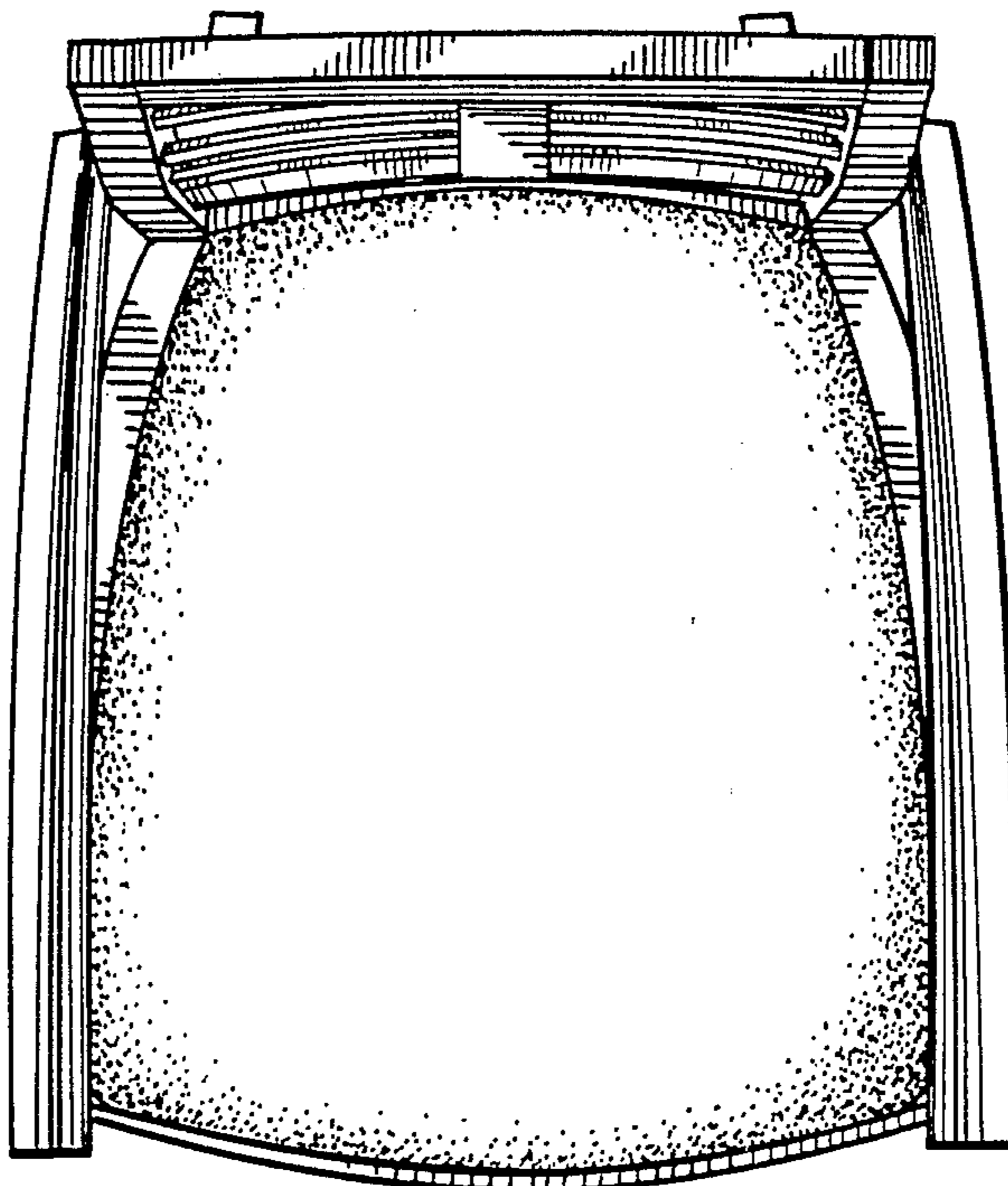

FIG. 10

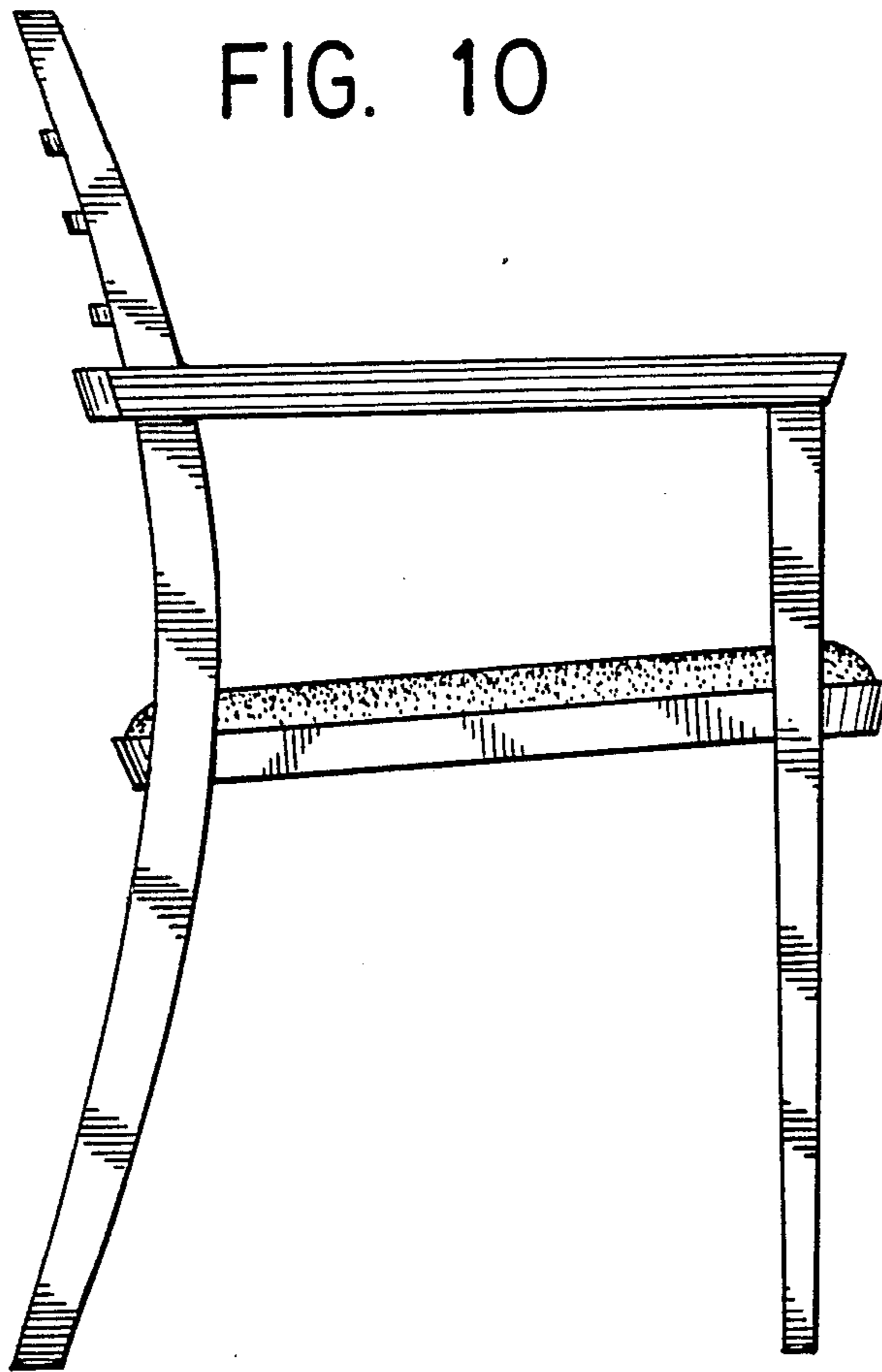

FIG. 11

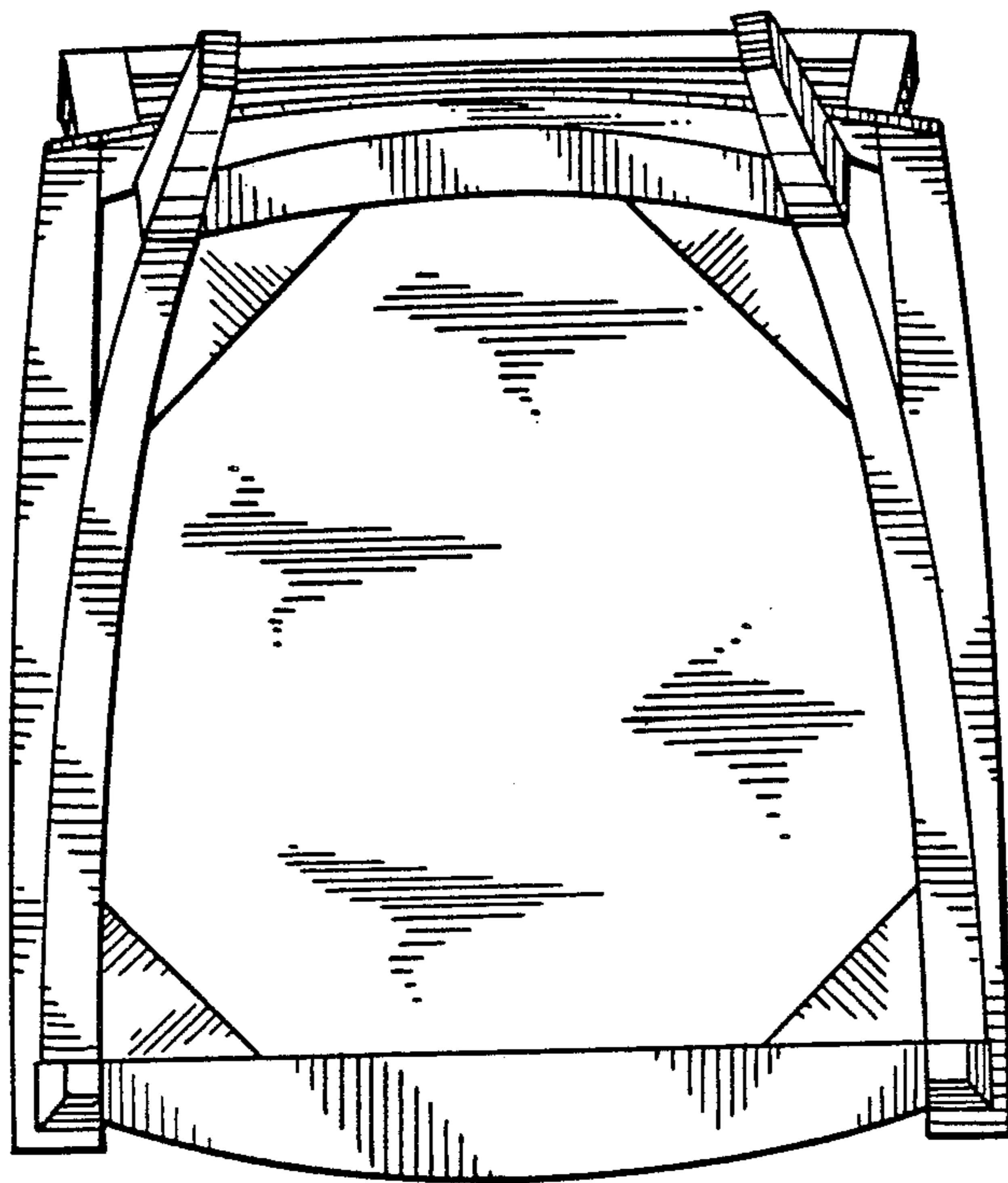

FIG. 12

