

[54] WHEELBARROW TRAY EXTENDER

[76] Inventor: Bruce L. Batchelor, 23401 SW. 124 Ave., Homestead, Fla. 33032

[**] Term: 14 Years

[21] Appl. No.: 278,541

[22] Filed: Dec. 1, 1988

[52] U.S. Cl. D34/27; D34/16

[58] Field of Search D34/12, 16, 27; 280/653, 47.31, 47.18; 296/37.4, 37.1, 35.3, 35.4

[56] References Cited

U.S. PATENT DOCUMENTS

- D. 301,650 6/1989 Germain D34/16
- 4,227,709 10/1980 Gradwohl et al. 280/47.18
- 4,645,225 2/1987 Eubanks D34/16

Primary Examiner—Wallace R. Burke

Assistant Examiner—Kay H. Chin
Attorney, Agent, or Firm—Robert J. Van Der Wall

[57] CLAIM

The ornamental design for a wheelbarrow tray extender, as shown and described.

DESCRIPTION

FIG. 1 is a side perspective view of a wheelbarrow tray extender showing my new design, the opposite side perspective view being a mirror image of that shown. It being understood that the broken lines are for illustrative purposes only and form no part of the claimed design;

FIG. 2 is a top plan view thereof;

FIG. 3 is a side elevational view thereof, the opposite side view being a mirror image of that shown;

FIG. 4 is a bottom plan view thereof;

FIG. 5 is a rear elevational view thereof; and

FIG. 6 is a front elevational view thereof.

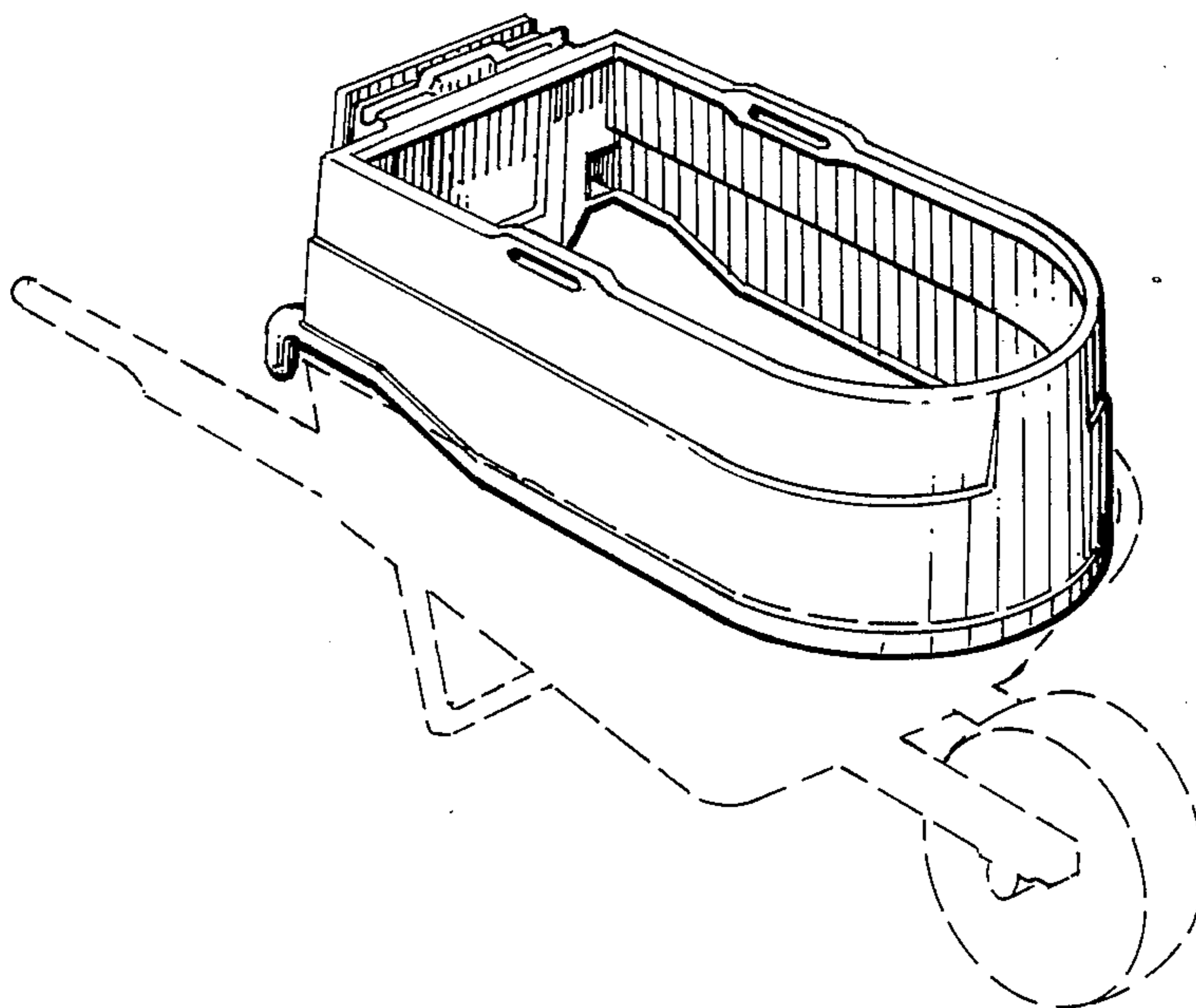

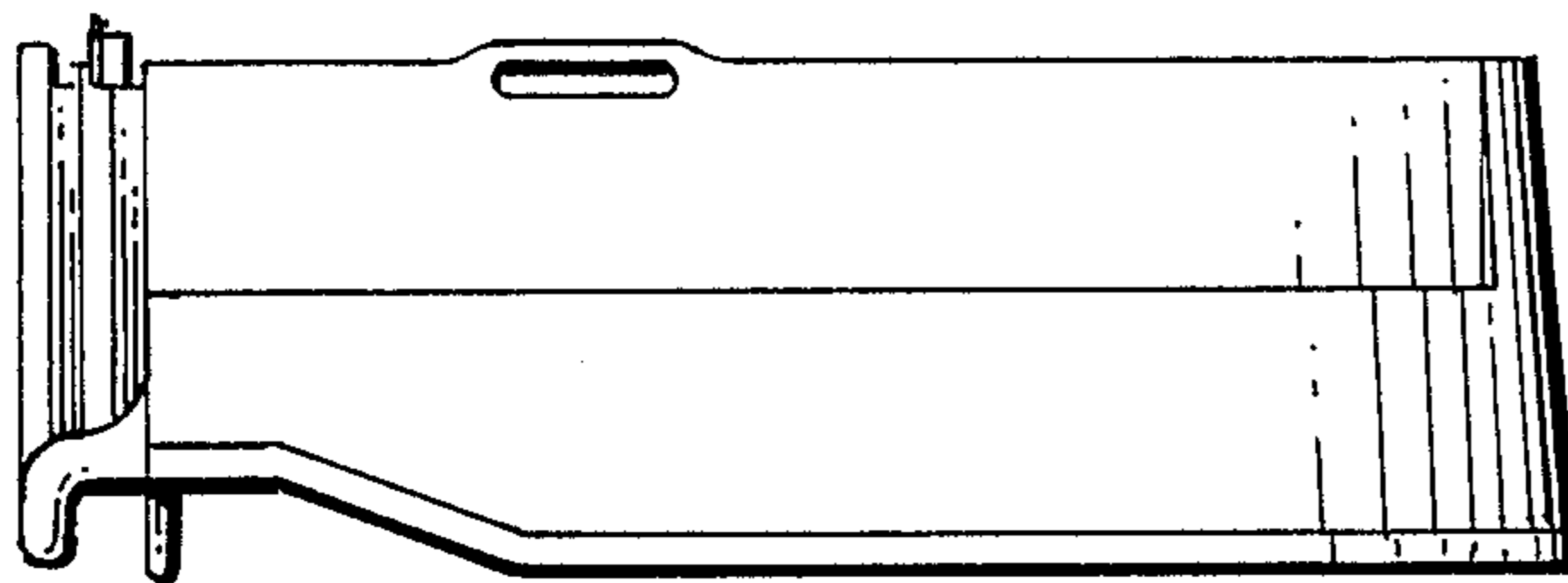
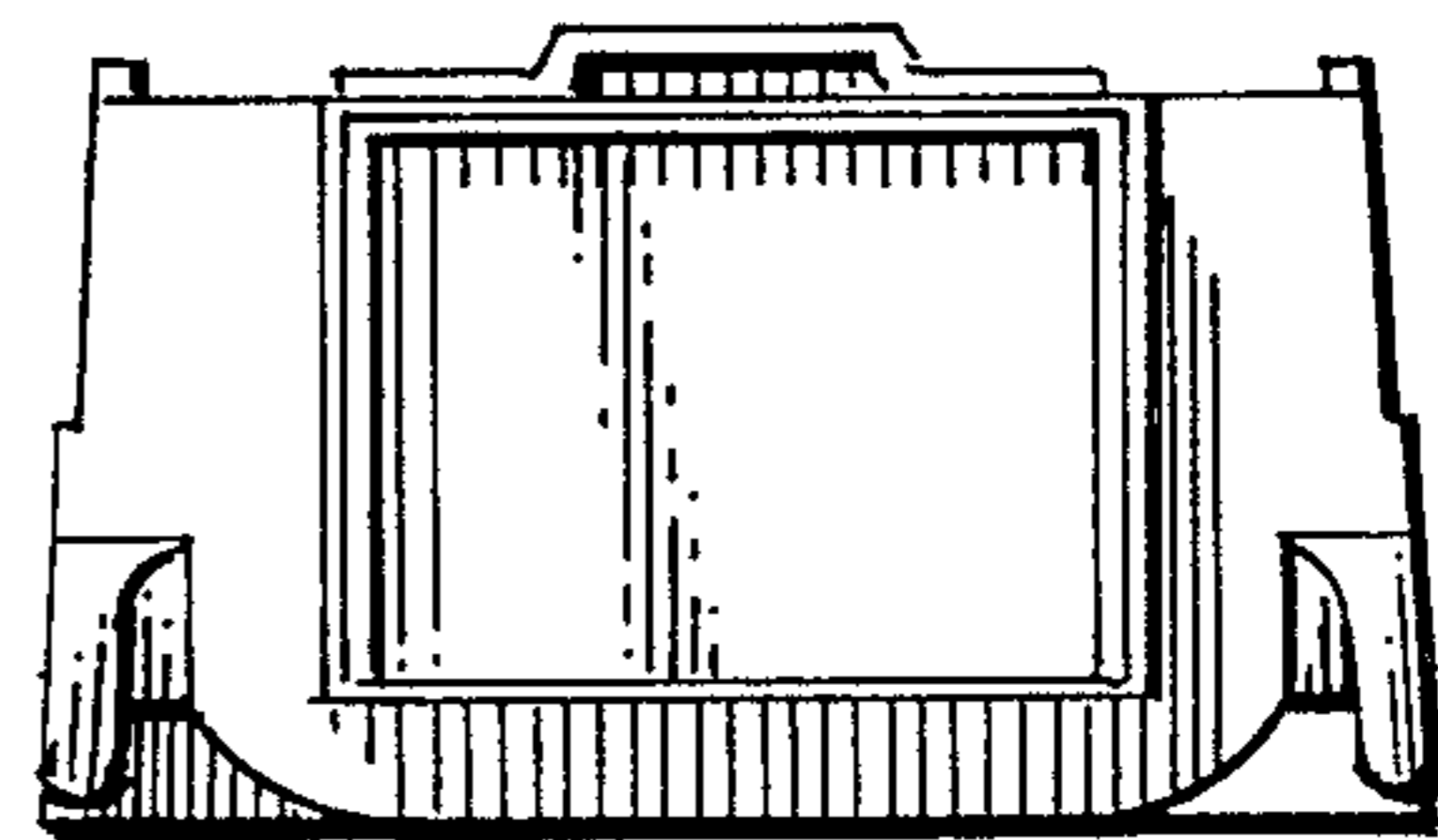
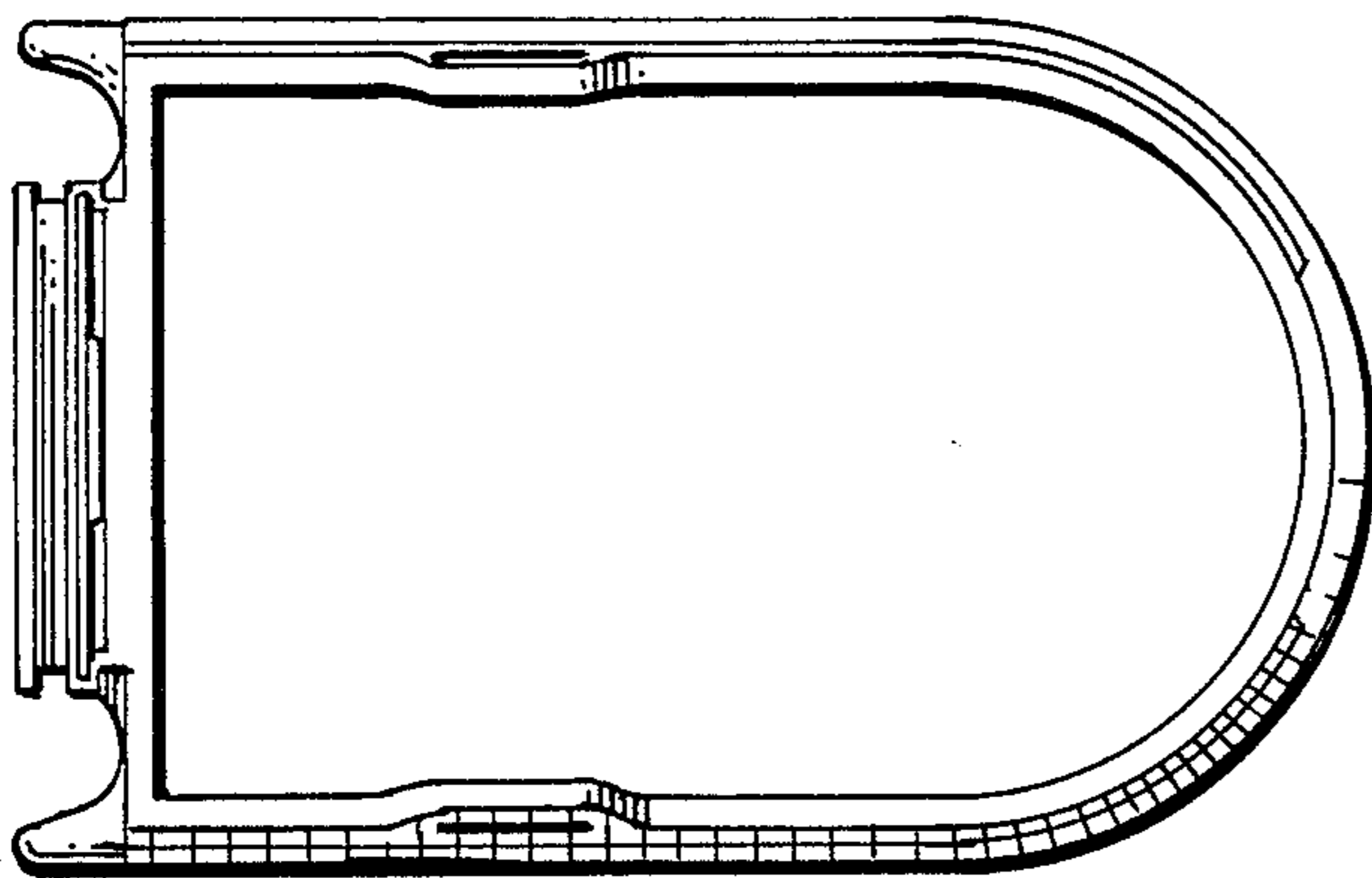
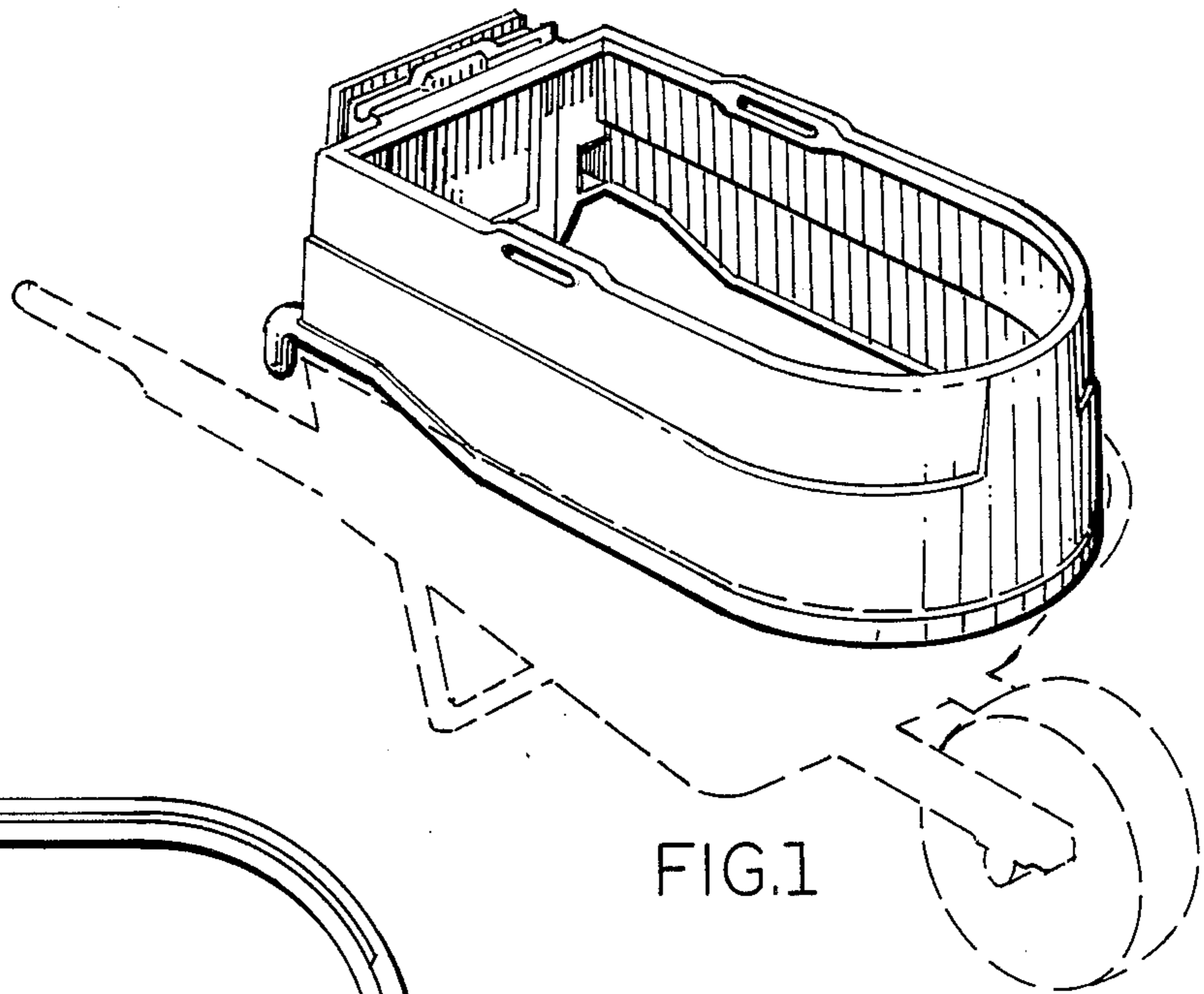

FIG. 5

FIG. 3

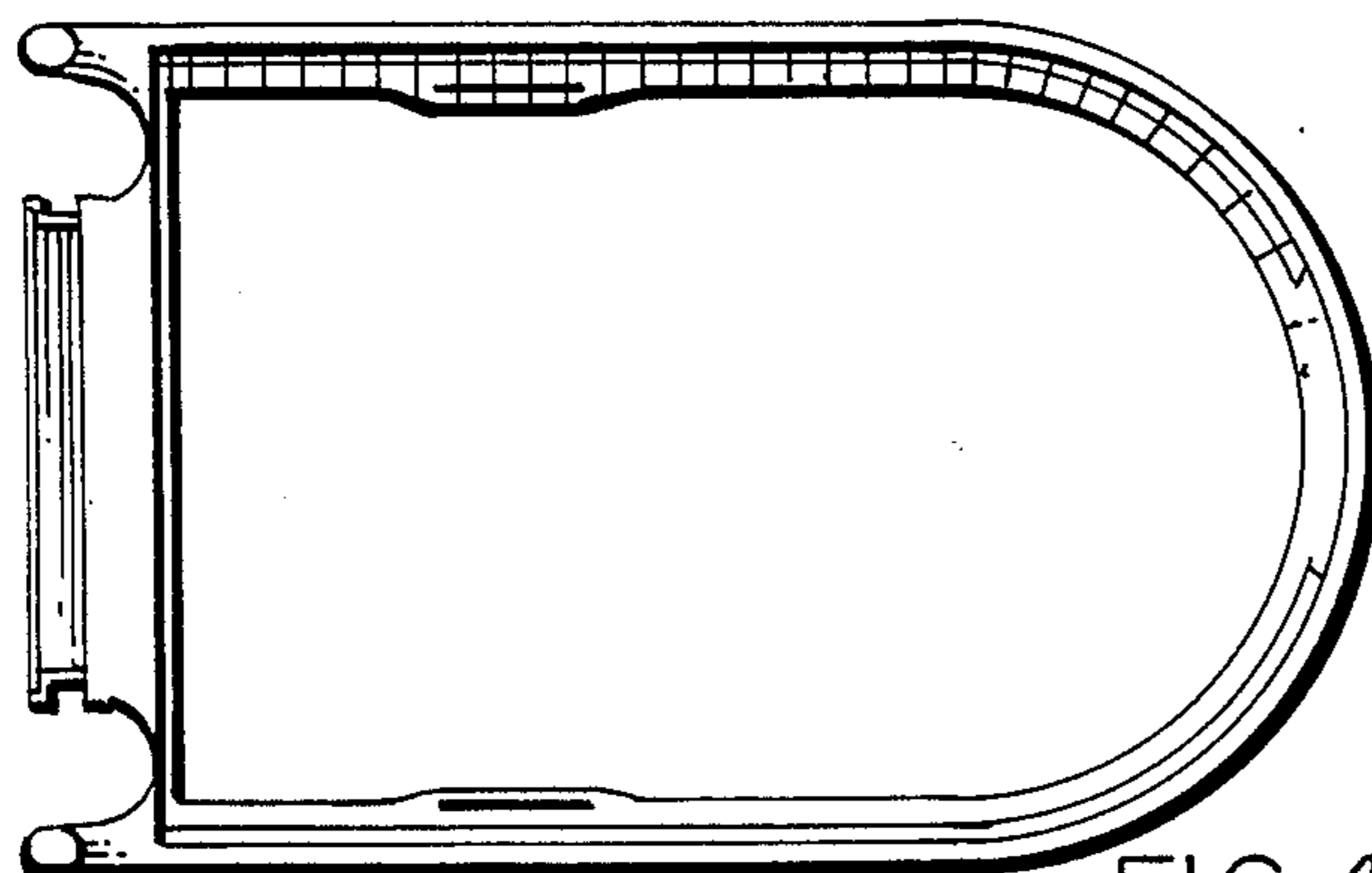

FIG. 6

FIG. 4

