

[54] **CLAMP FOR HOLDING SOCKS TOGETHER WHEN LAUNDERING**

[76] **Inventors: Wayne Holladay; Barbara Holladay,**
both of 30 College Ave., Rexburg,
Id. 83440

[**] **Term: 14 Years**

[21] **Appl. No.: 58,751**

[22] **Filed: Jun. 5, 1987**

[52] **U.S. Cl. D32/61; D32/35**

[58] **Field of Search D32/35, 61; 2/265;**
24/94-95, 303, 455, 620-622, 687-692, 694

[56] **References Cited**

U.S. PATENT DOCUMENTS

D. 192,076	1/1962	Coughlin	D32/61
D. 231,310	4/1974	Burgher	D32/61
1,741,027	12/1929	King	2/265
2,071,507	2/1937	Dews	24/691 X
3,049,777	8/1962	Lewin	24/620

FOREIGN PATENT DOCUMENTS

2312717 9/1974 Fed. Rep. of Germany 2/265

Primary Examiner—Wallace R. Burke
Assistant Examiner—Lavone D. Tabor
Attorney, Agent, or Firm—K. S. Cornaby

[57] **CLAIM**

The ornamental design for a clamp for holding socks together when laundering, as shown.

DESCRIPTION

FIG. 1 is an exploded perspective view of a clamp for holding socks together when laundering showing our new design;

FIG. 2 is a front elevational view thereof;

FIG. 3 is a rear elevational view thereof;

FIG. 4 is a left side elevational view thereof;

FIG. 5 is a right side elevational view thereof;

FIG. 6 is a top plan view thereof; and

FIG. 7 is a bottom plan view thereof.

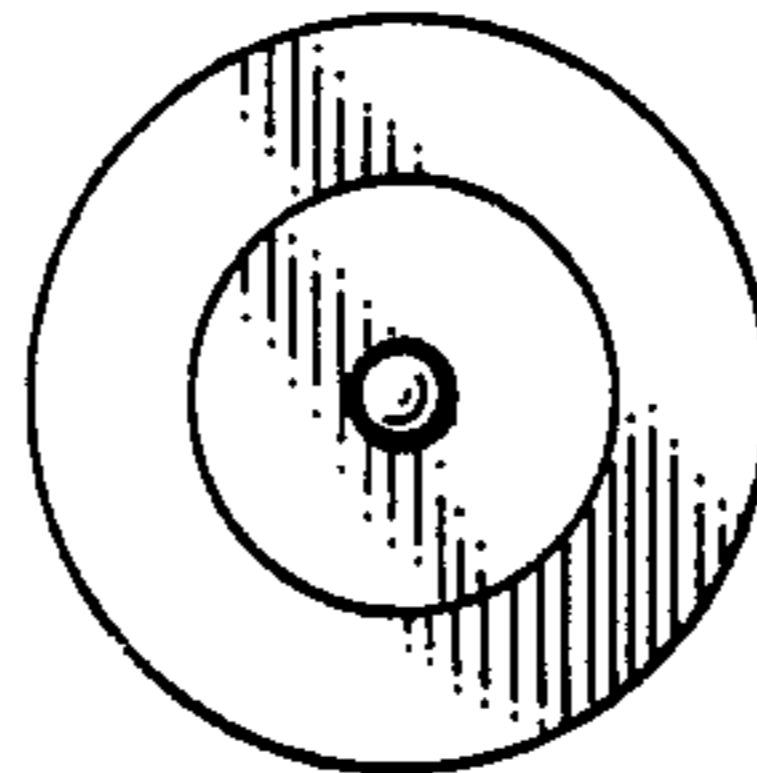
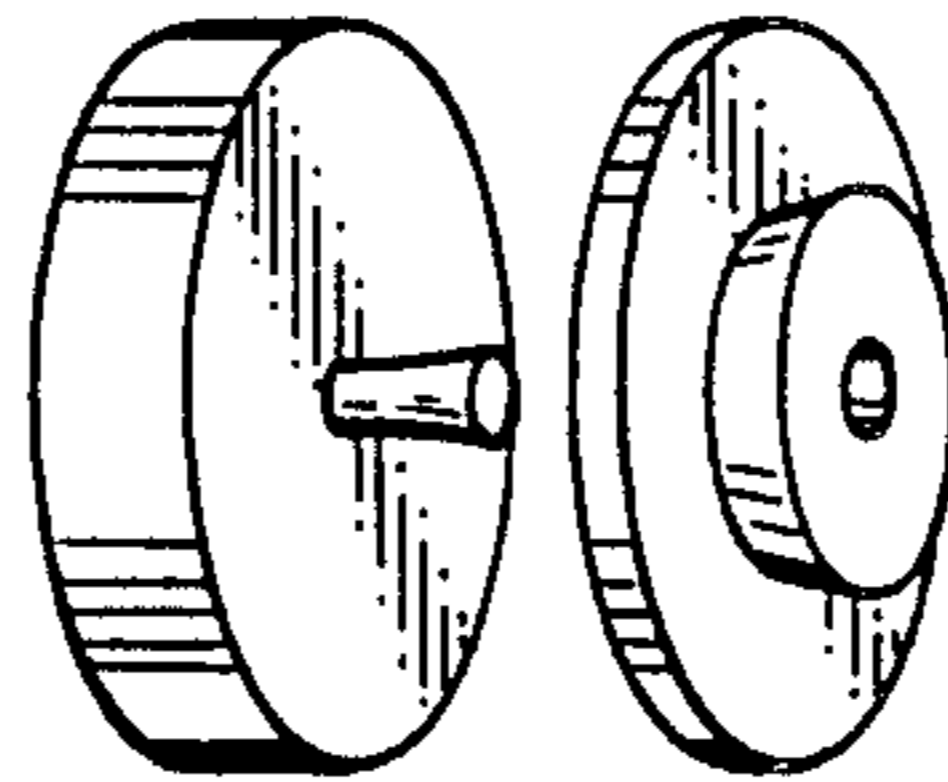

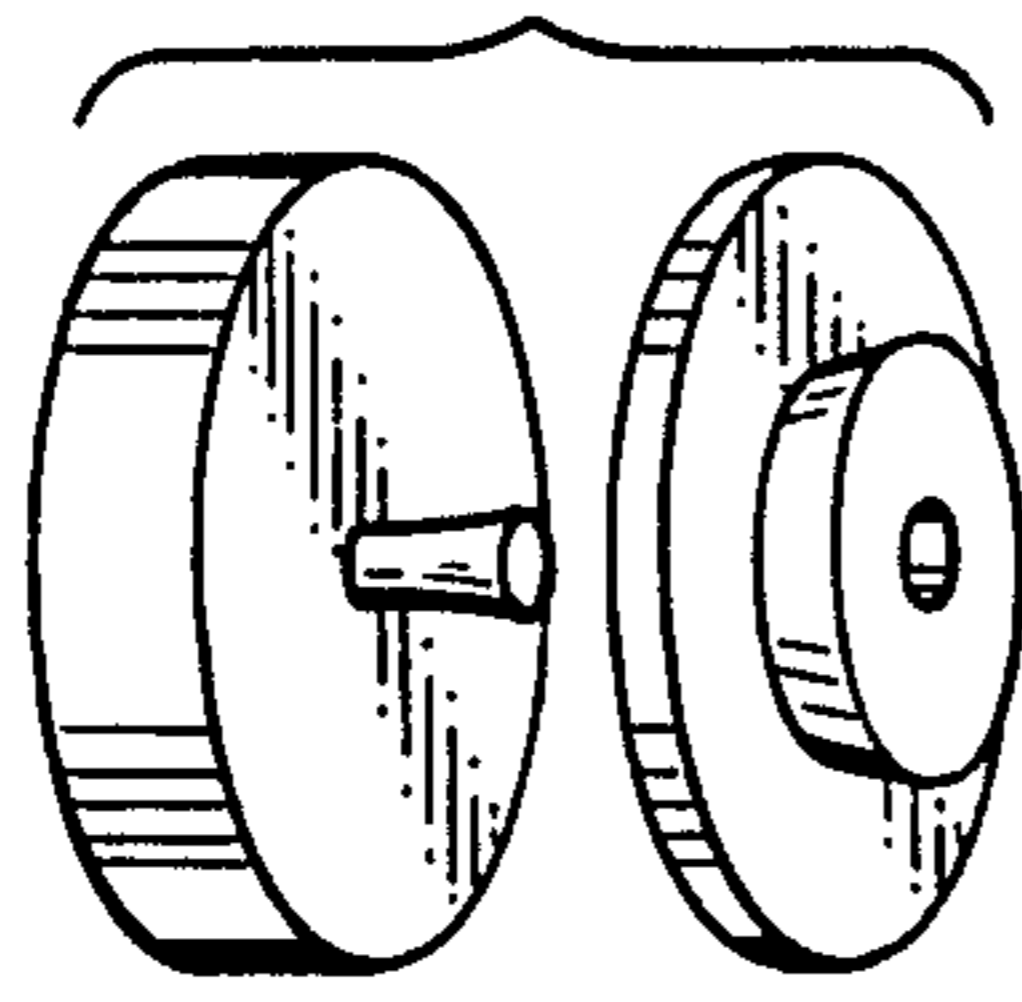

FIG. 1

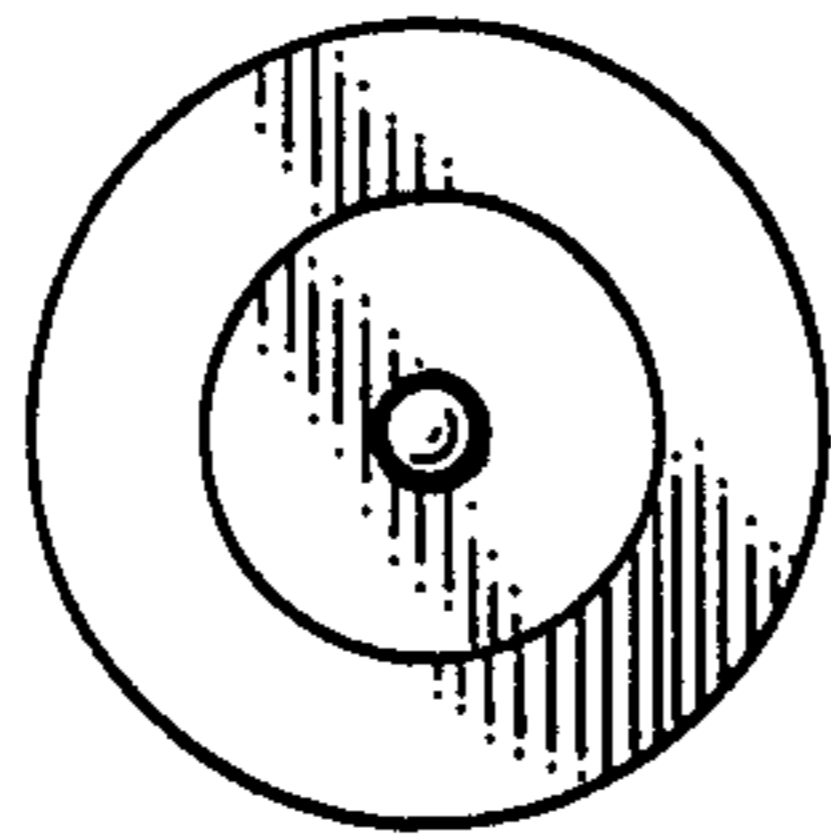

FIG. 2

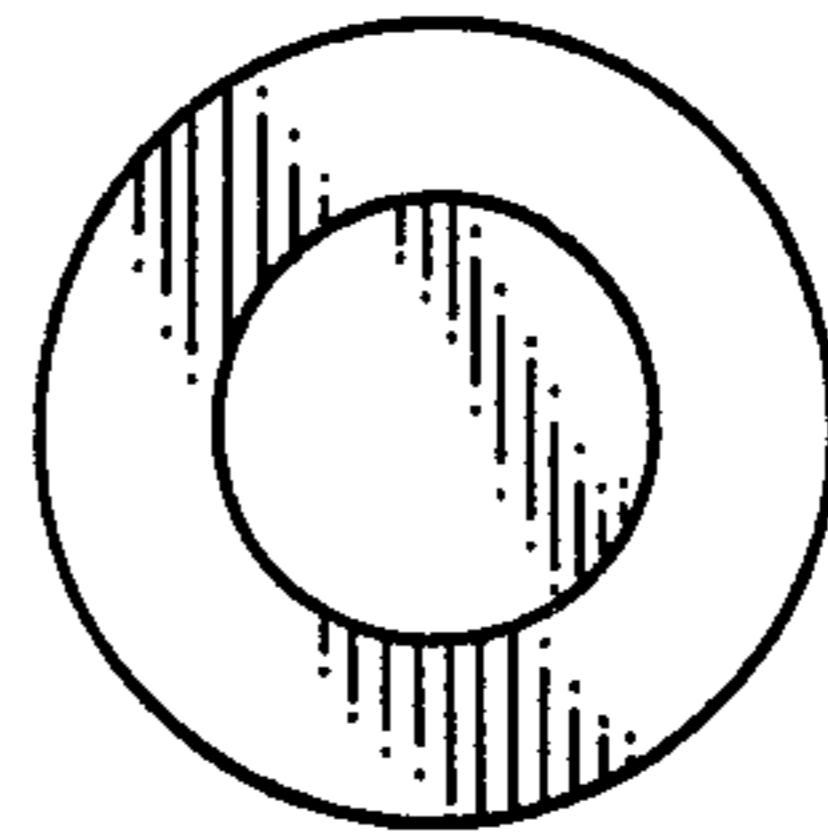

FIG. 3

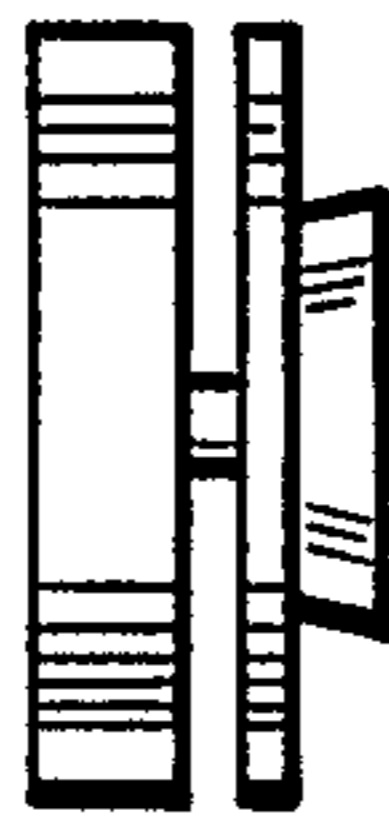

FIG. 4

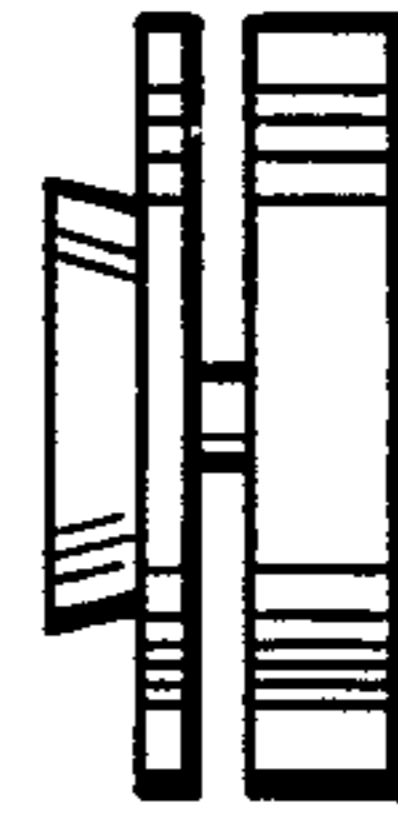

FIG. 5

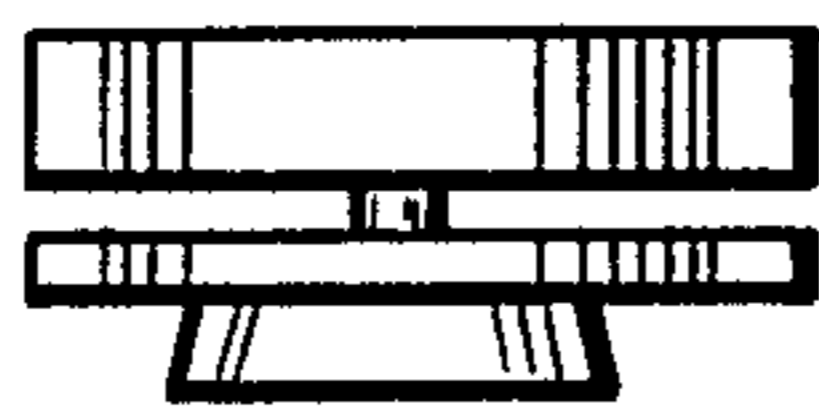

FIG. 6

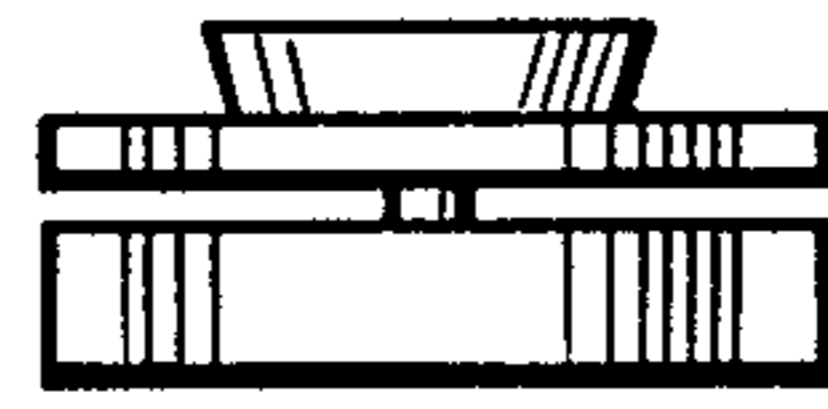

FIG. 7