

[54] COMBINED TAPE RECORDER AND RADIO RECEIVER

[75] Inventor: Yasuaki Isonaga, Kawasaki, Japan

[73] Assignee: Sony Corporation, Tokyo, Japan

[**] Term: 14 Years

[21] Appl. No.: 193,358

[22] Filed: May 12, 1988

[30] Foreign Application Priority Data

Nov. 12, 1987 [JP] Japan 62-46357

[52] U.S. Cl. D14/163; D14/168

[58] Field of Search D14/141, 160-168, D14/188-189, 191-192, 196, 199, 202, 299; 455/344, 350, 351

[56] References Cited

U.S. PATENT DOCUMENTS

- D. 273,379 4/1984 Hamada et al. D14/163
- D. 294,567 3/1988 Fujii D14/163
- D. 297,834 9/1988 Kawabe et al. D14/163

OTHER PUBLICATIONS

HFD; 01/05/87; p. 116 (insert) Sanyo Model MS450. HFD; 06/01/87; p. 116; top right-Gran Prix Dual Cassette Portable Stereo.

Primary Examiner—Theodore M. Shooman
Attorney, Agent, or Firm—Lewis H. Eslinger; Jay H. Maioli

[57] CLAIM

The ornamental design for a combined tape recorder and radio, as shown and described.

DESCRIPTION

FIG. 1 is a top, front, and right-side perspective view of a combined tape recorder and radio receiver, showing my new design;

FIG. 2 is a top, front and right-side perspective view thereof, shown with handle in the upraised position and antenna in the extended position;

FIG. 3 is a front elevational view thereof;

FIG. 4 is a rear elevational thereof;

FIG. 5 is a left-side elevational view thereof;

FIG. 6 is a right-side elevational view thereof;

FIG. 7 is a top plan view thereof; and

FIG. 8 is a bottom plan view thereof.

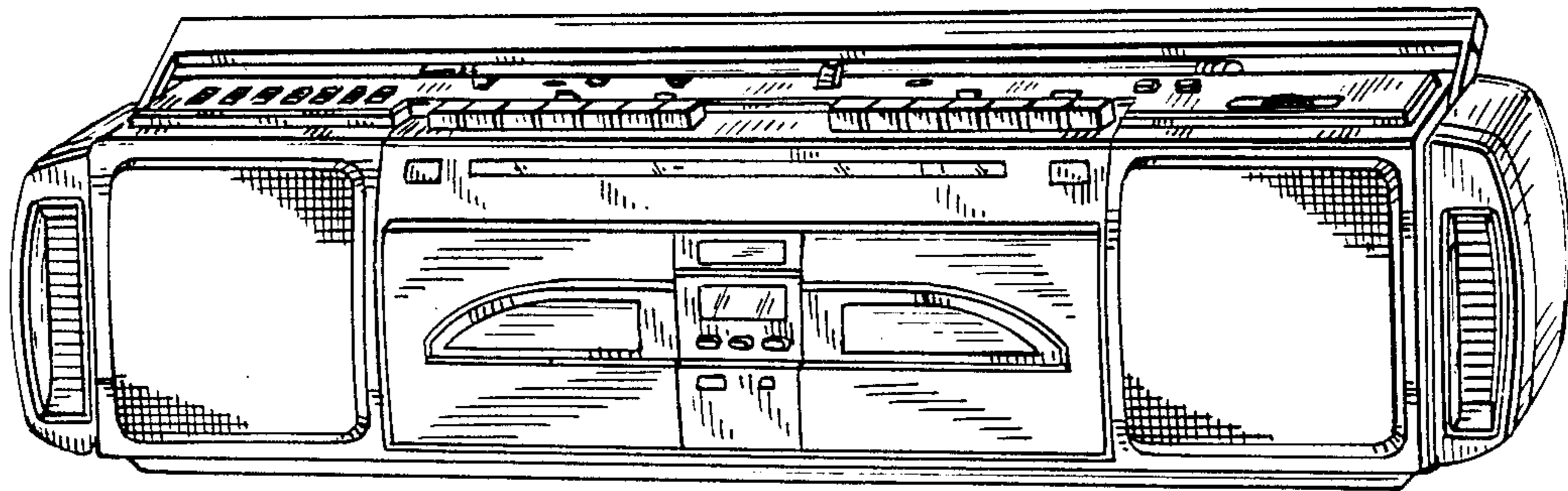

FIG. 1

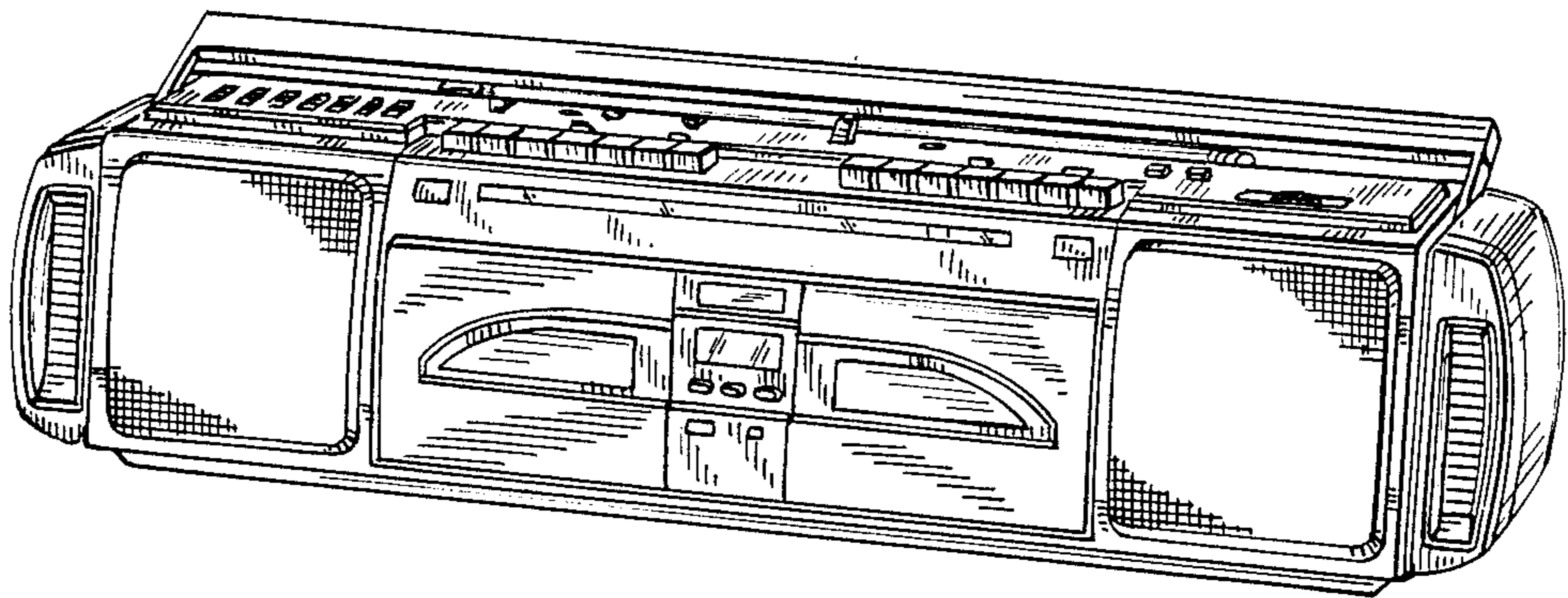

FIG. 2

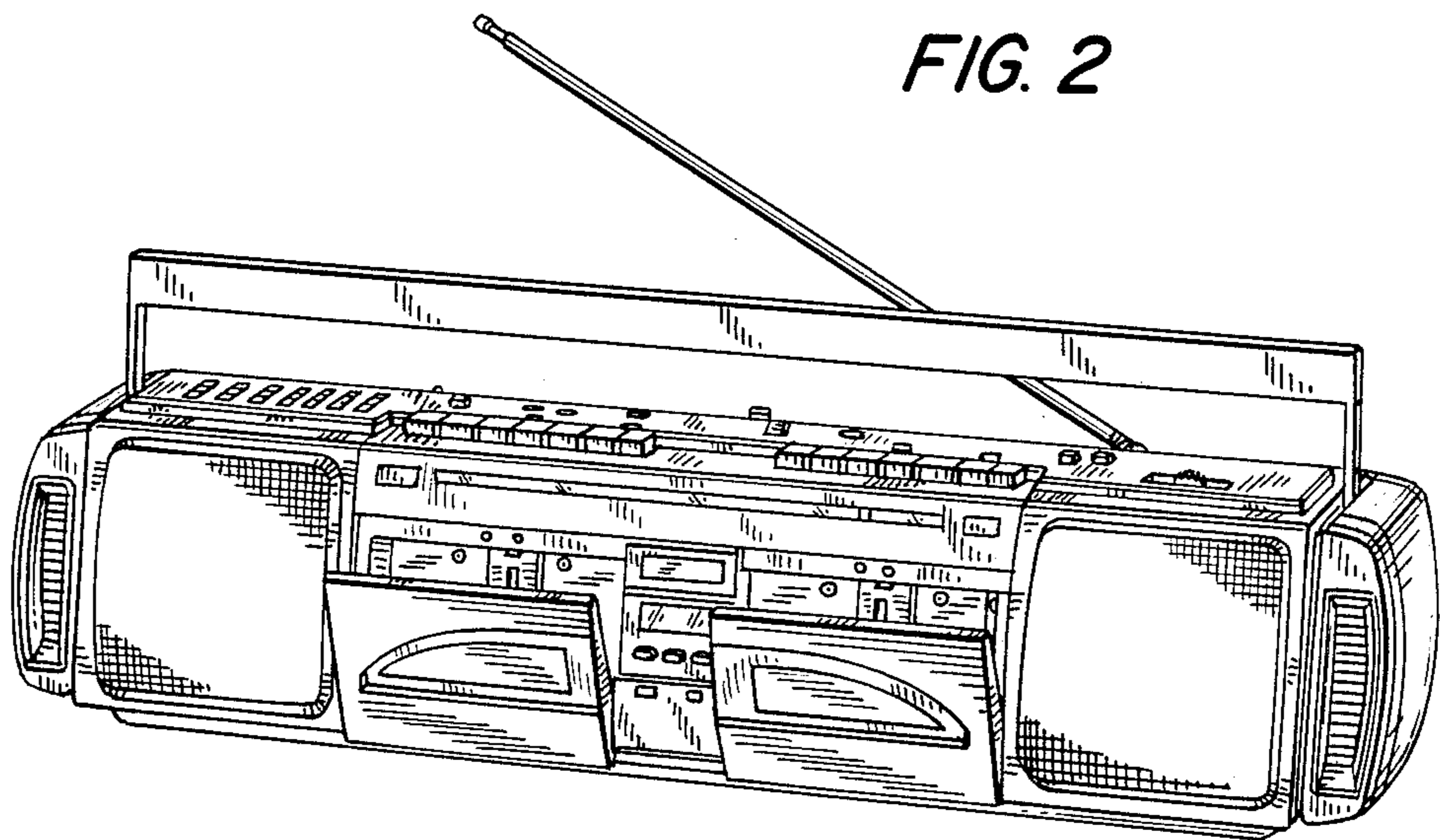

FIG. 3

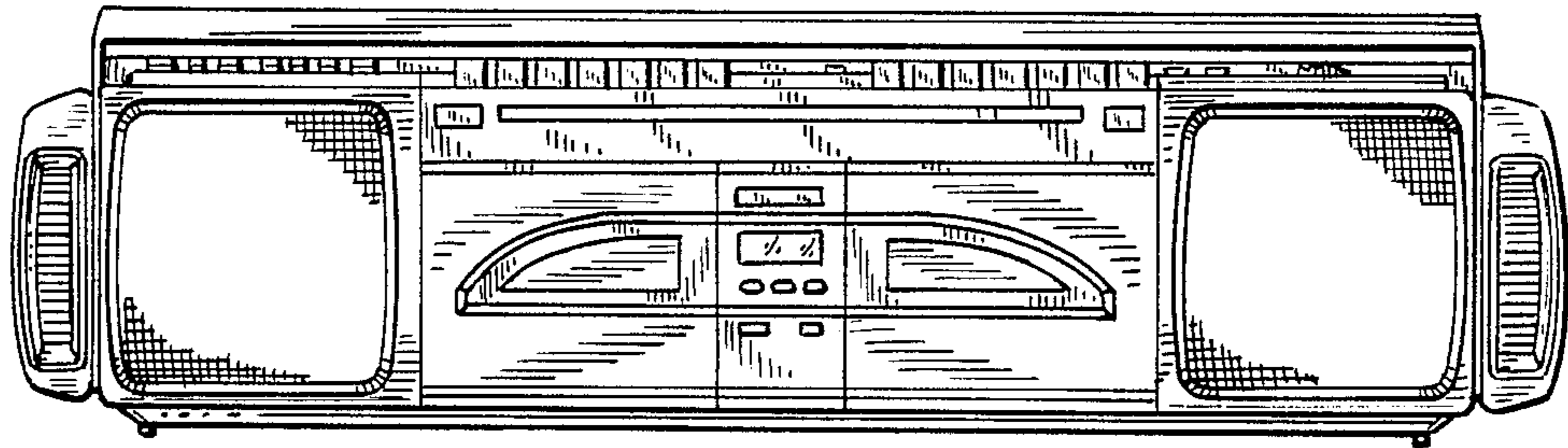

FIG. 5

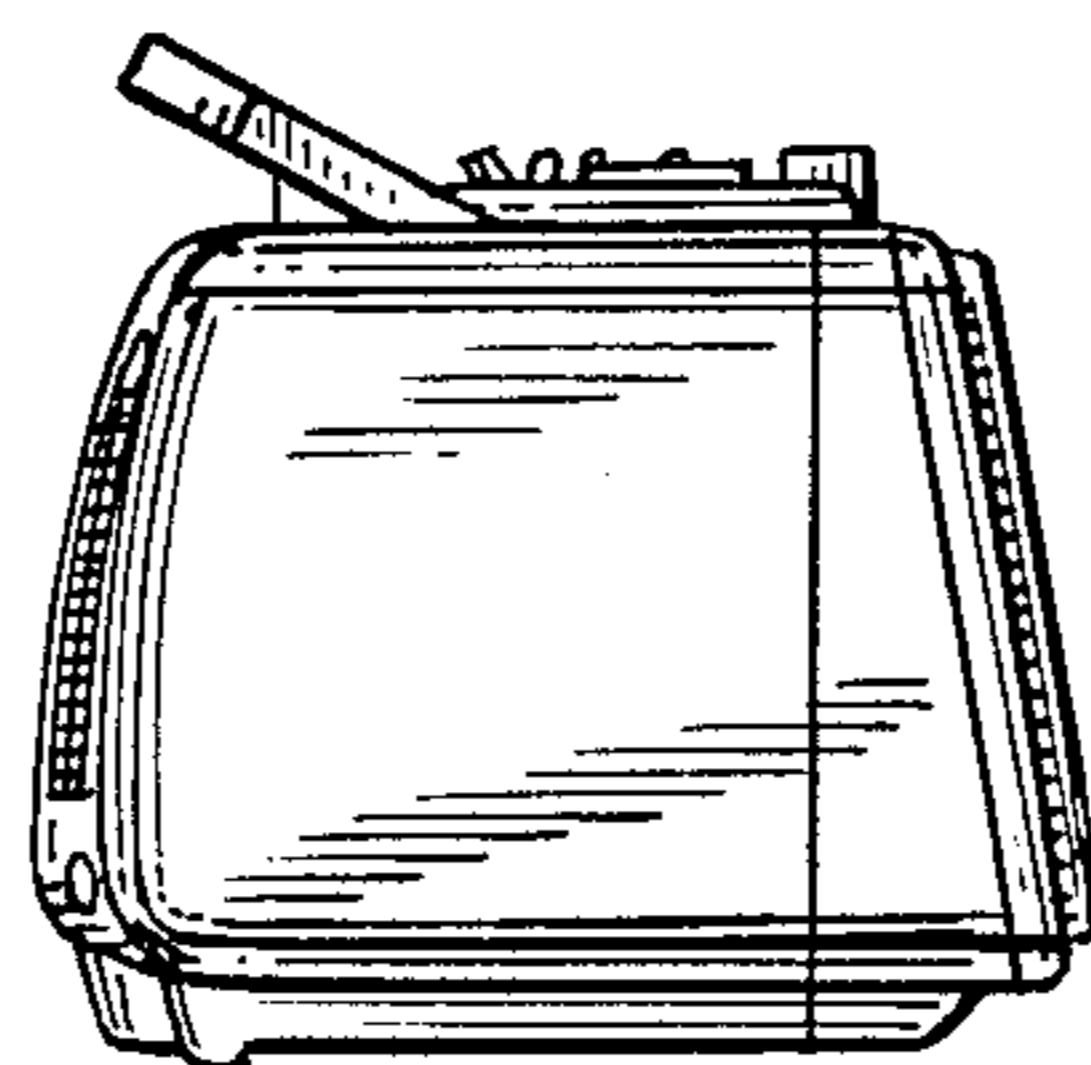

FIG. 4

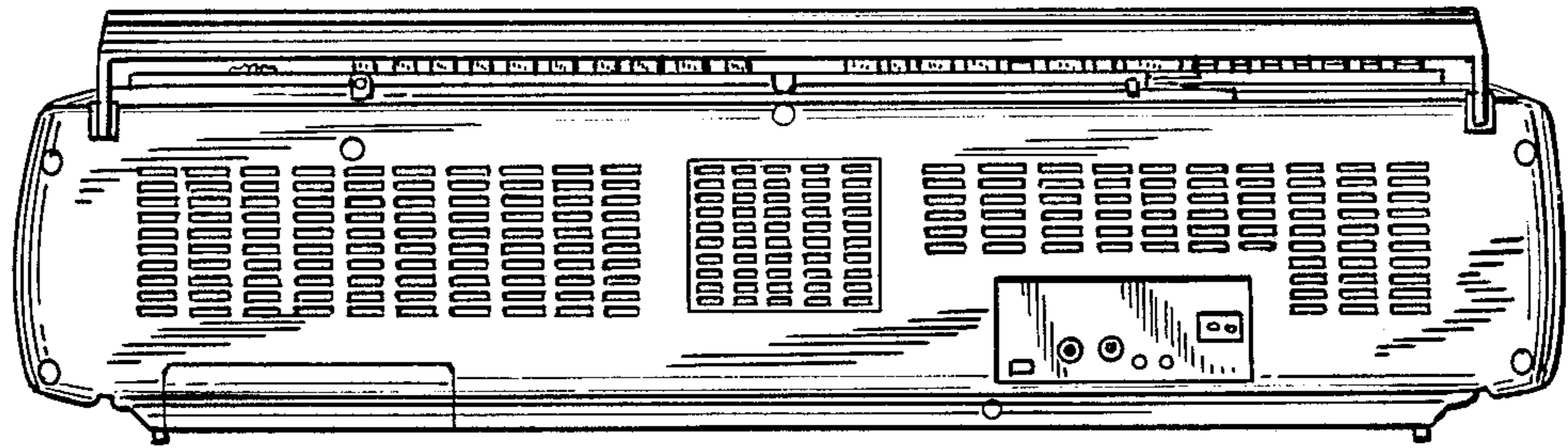

FIG. 8

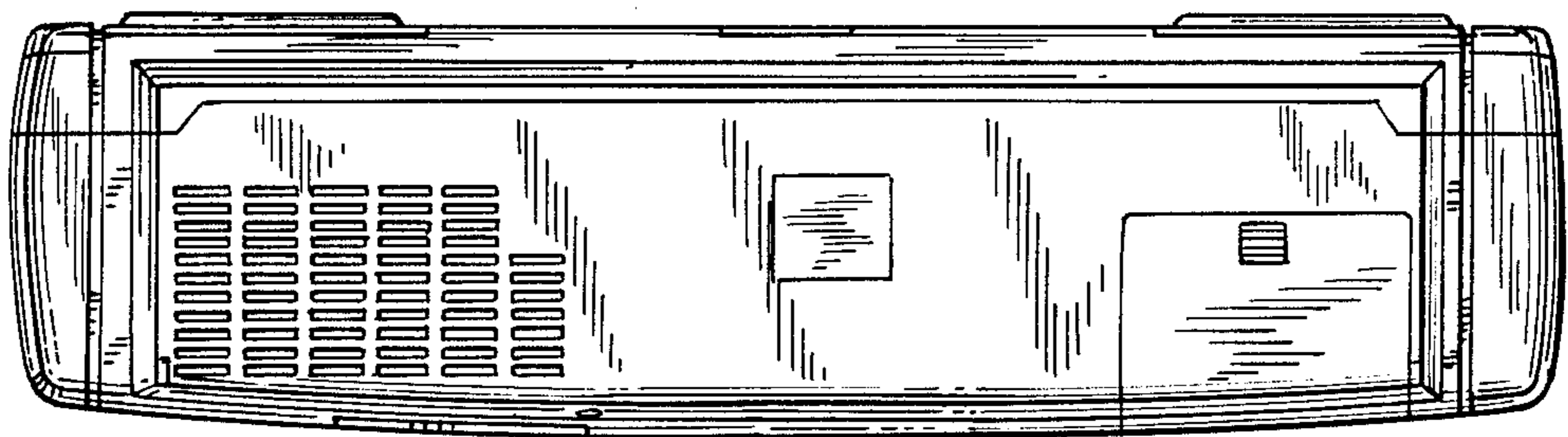

FIG. 6

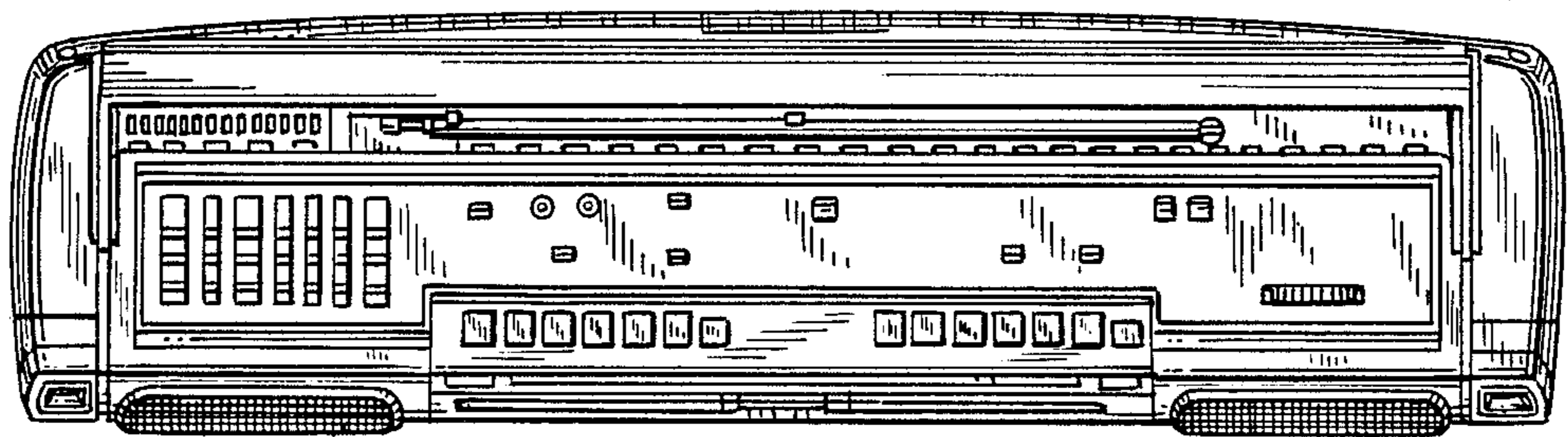
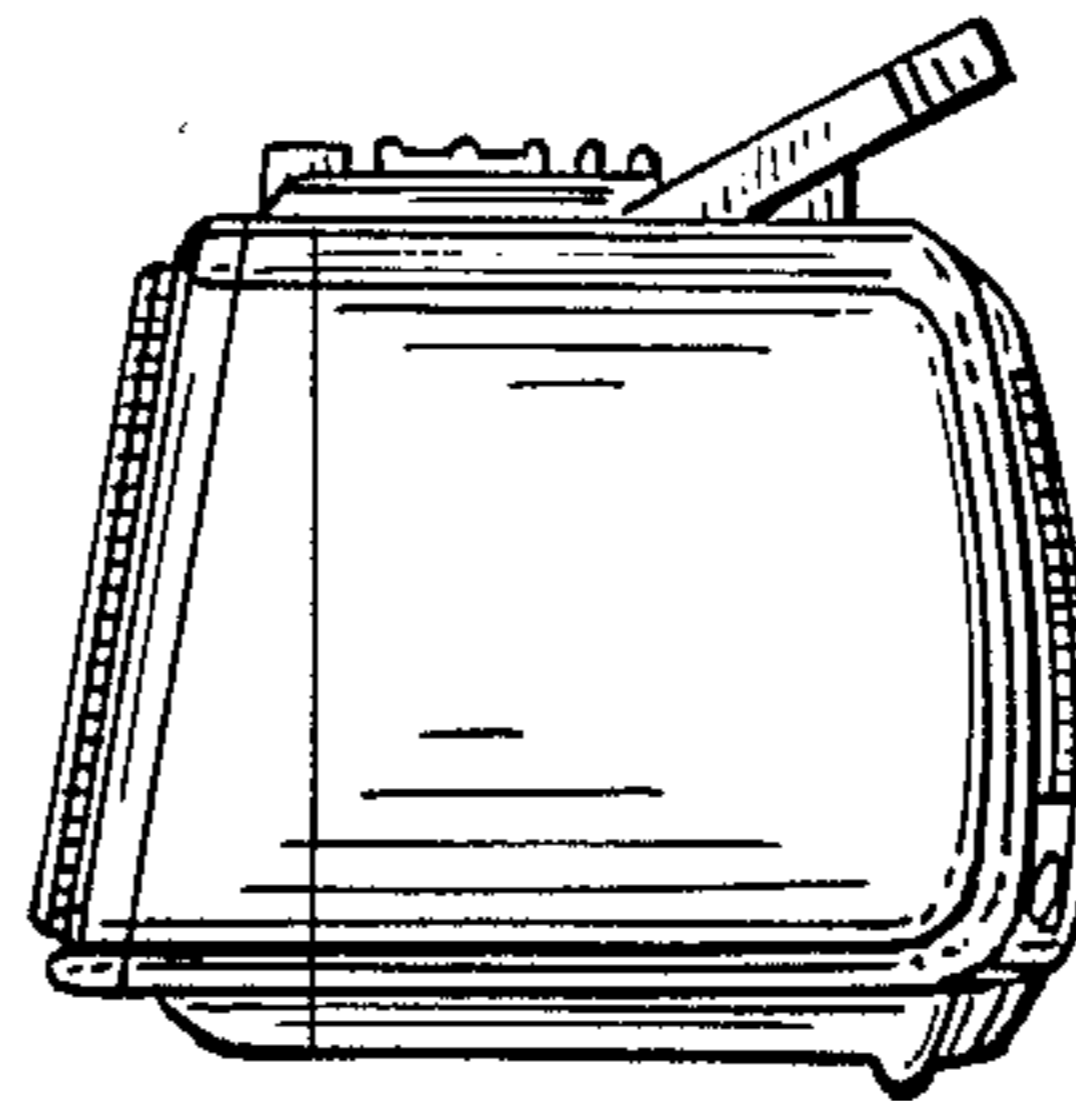

FIG. 7