

[54] **EMERGENCY MEDICAL INFORMATION CONTAINER**

[75] Inventor: Samuel F. Speers, Sarasota, Fla.

[73] Assignee: Design Data, Inc., East Greenwich, R.I.

[**] Term: 14 Years

[21] Appl. No.: 51,674

[22] Filed: May 18, 1987

[52] U.S. Cl. D9/418

[58] Field of Search D9/414-433, D9/446; D24/56, 99; 206/803, 828, 534, 535, 493, 806, 45.34, 45.31, 218, 569, 570; 229/41 R, 904.1

4,063,639 12/1977 Grant 220/45
 4,294,352 10/1981 Fitzke 206/803

OTHER PUBLICATIONS

Packaging Catalog, 1945, p. 152, item No. 6 (shown by arrow).

Modern Packaging Encyclopedia, 1958, p. 347, Extension Edge Box (shown by arrow).

Primary Examiner—Bernard Ansher
 Assistant Examiner—Prabhakar Deshmukh
 Attorney, Agent, or Firm—Salter & Michaelson

[57] CLAIM

The ornamental design for an emergency medical information container, as shown and described.

DESCRIPTION

FIG. 1 is a front elevation of my emergency medical information container showing my new design; FIG. 2 is a left side elevation thereof, the right side elevation being a mirror image thereof; FIG. 3 is a rear side elevation thereof; FIG. 4 is a top plan view thereof, the bottom plan view being a mirror image; FIG. 5 is an exploded view thereof; and FIG. 6 is a section taken on line 6—6 in FIG. 3.

[56] References Cited

U.S. PATENT DOCUMENTS

D. 197,740	3/1964	Shiffman	D9/420
D. 198,946	8/1964	Braun	D9/420
D. 265,346	7/1982	Maier	D24/99
D. 281,033	10/1985	Mohri	D3/30.1
D. 281,903	12/1985	Duffy	D24/99 X
1,739,920	12/1929	Schleicher	206/45.31
2,238,147	4/1941	Young	206/45.35

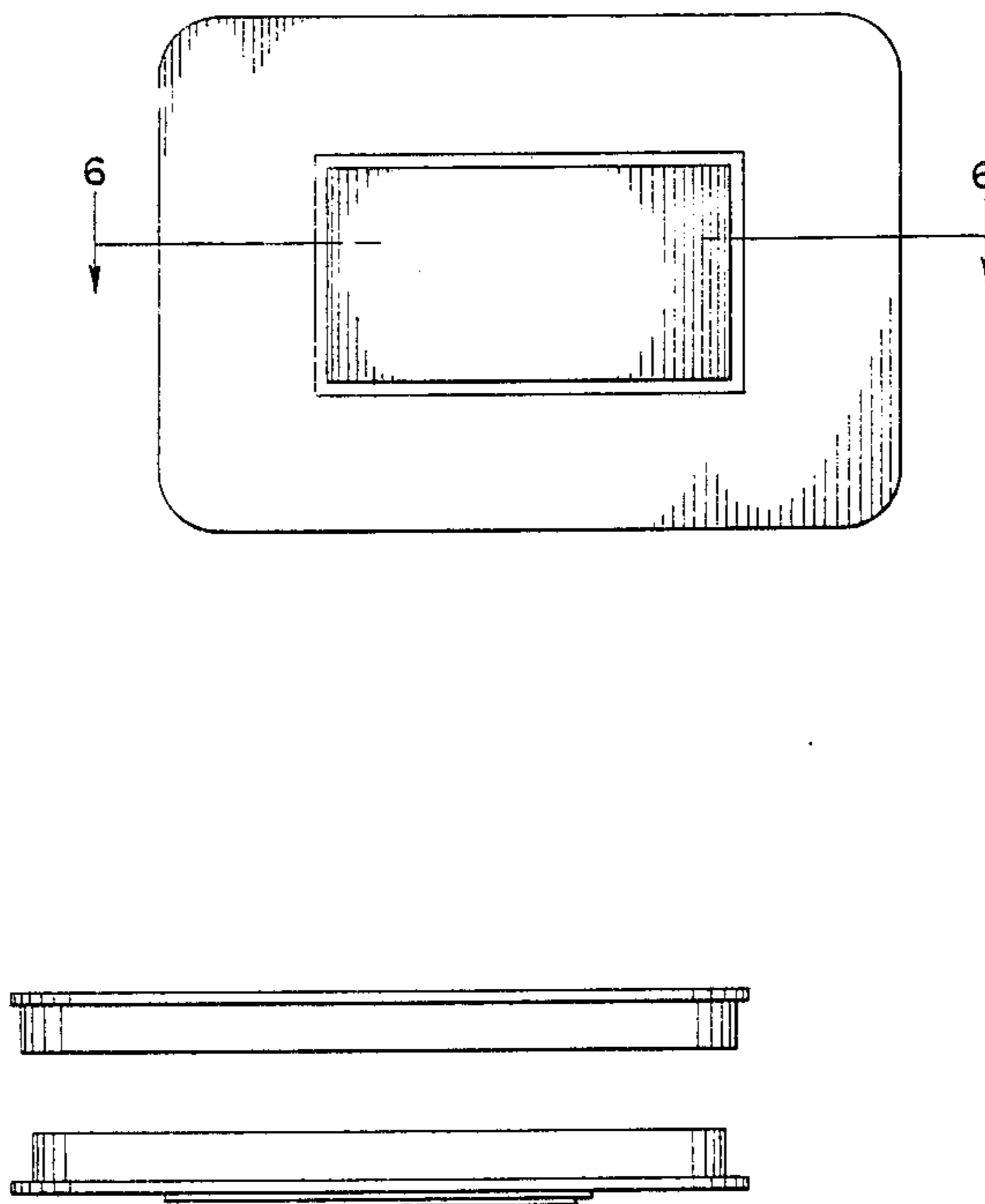

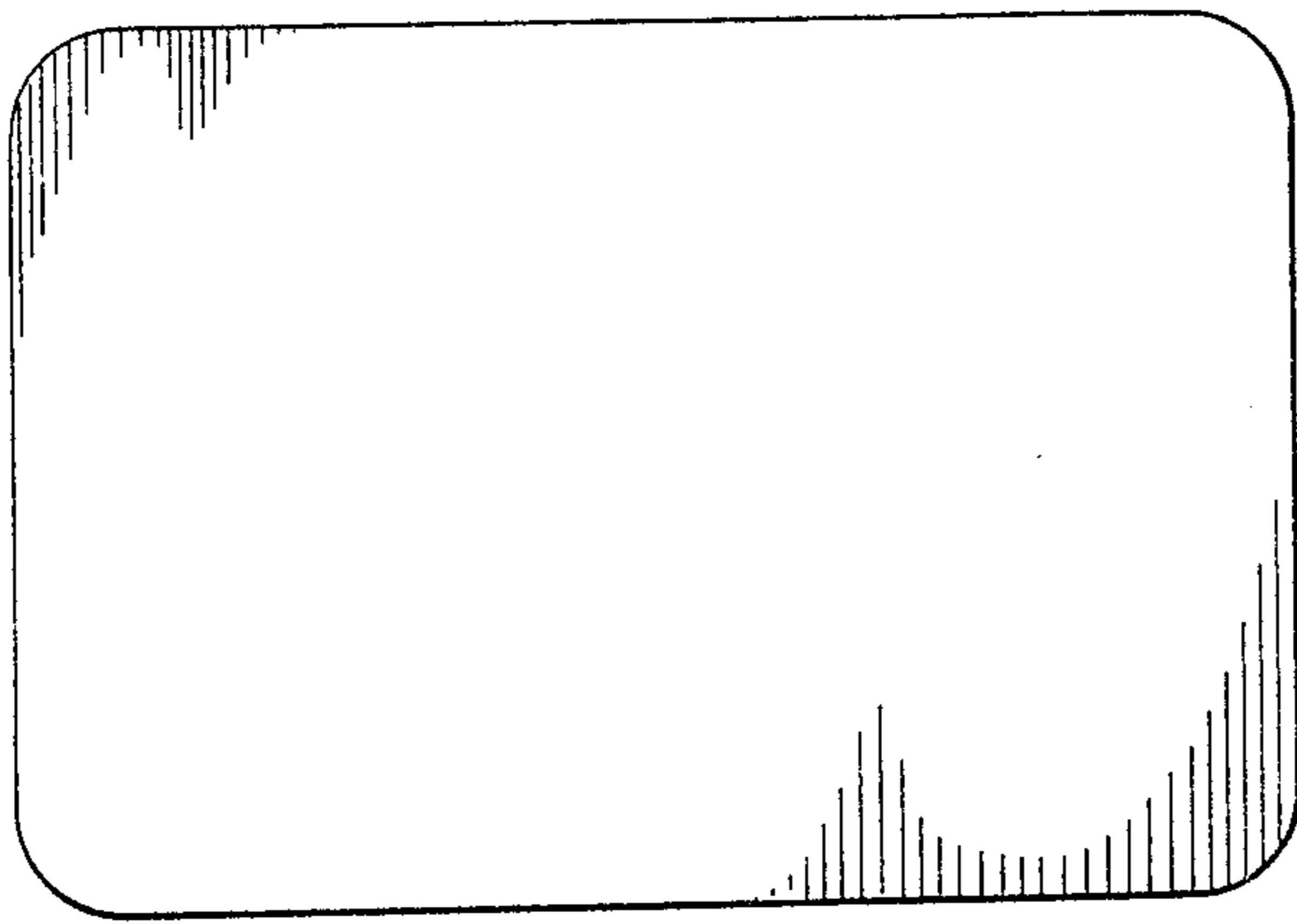

FIG. 1

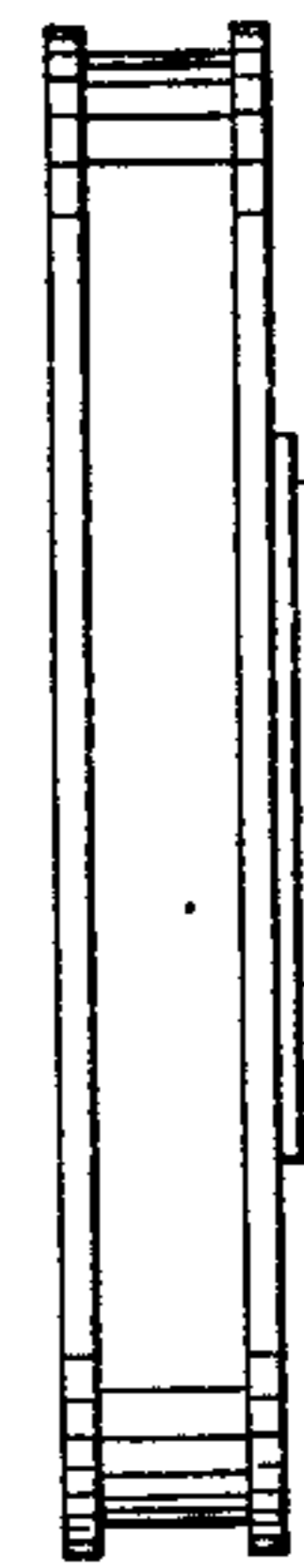

FIG. 2

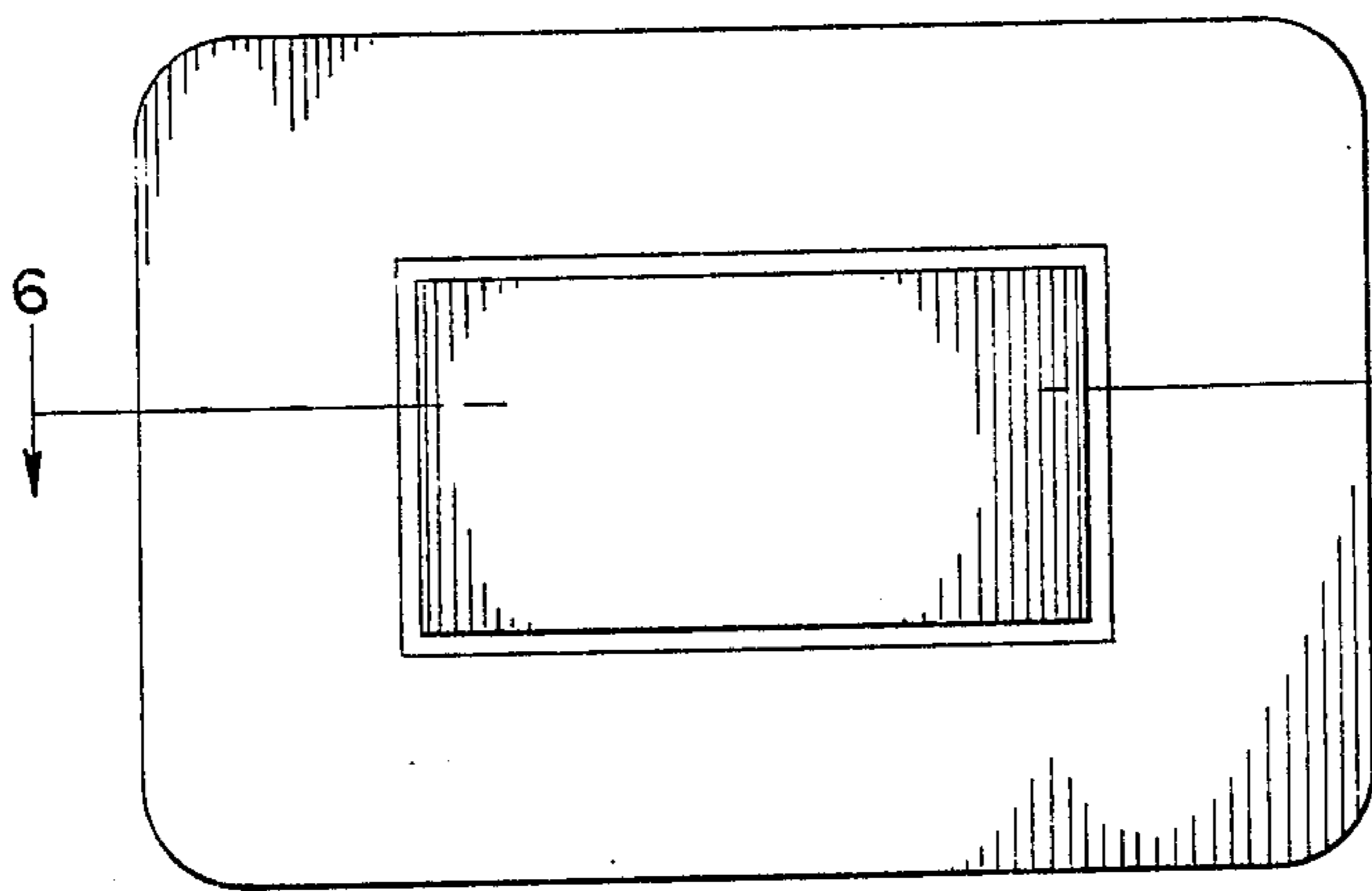

FIG. 3

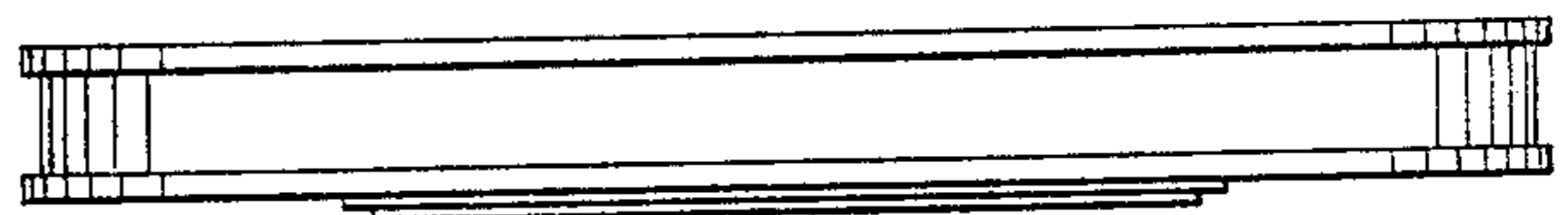

FIG. 4

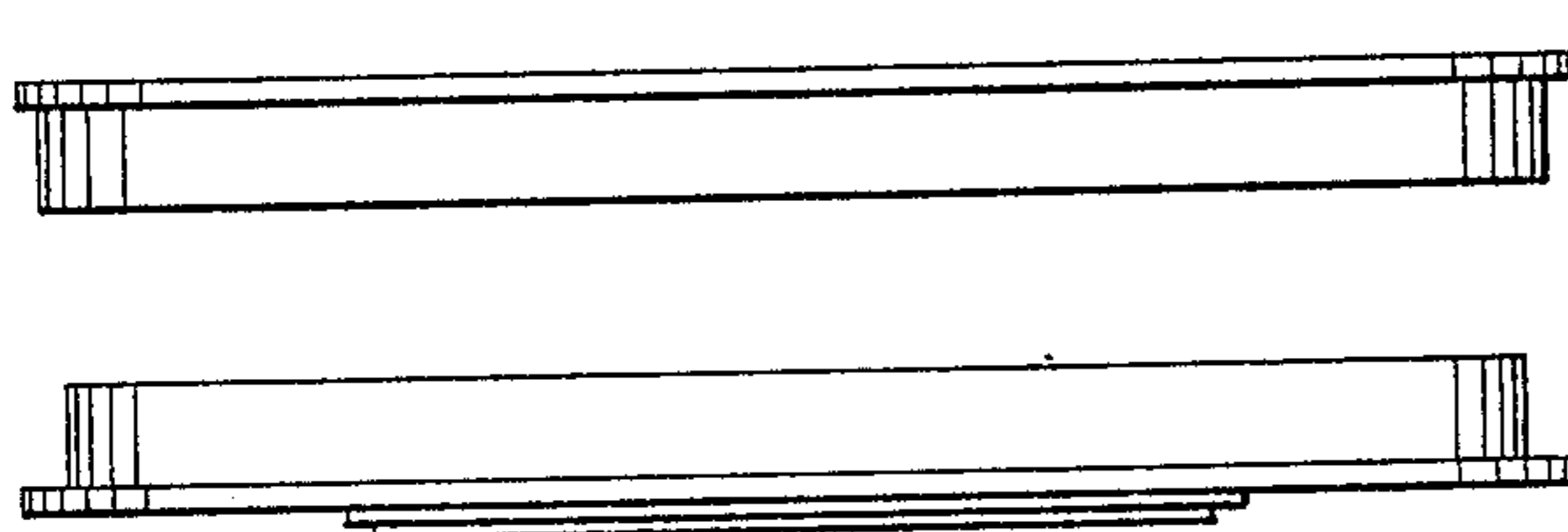

FIG. 5

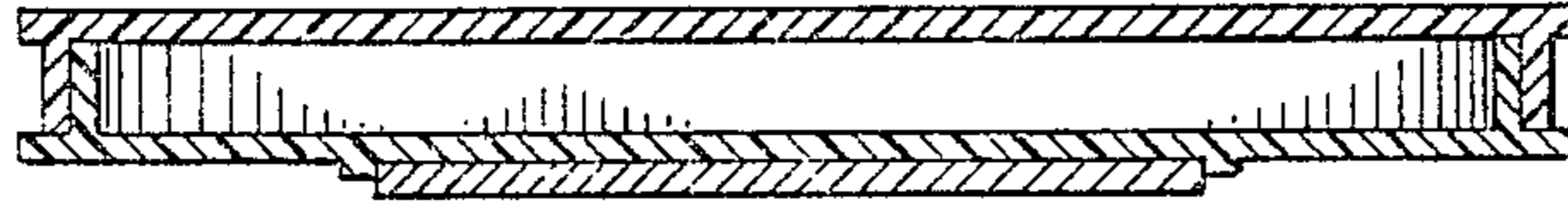

FIG. 6