

[54] **TONER CARTRIDGE**

[75] **Inventor: Yousuke Ohata, Osaka, Japan**

[73] **Assignee: Mita Industrial Co., Ltd., Osaka, Japan**

[**] **Term: 14 Years**

[21] **Appl. No.: 130,047**

[22] **Filed: Dec. 8, 1987**

[30] **Foreign Application Priority Data**

Jul. 2, 1987 [JP] Japan 62-26979

[52] **U.S. Cl. D18/43**

[58] **Field of Search D18/22, 43; D9/306, D9/373, 385, 390, 393, 399, 415, 418, 424, 425, 432; 206/316, 446, 461, 474, 495, 532, 601, 628, 631; 222/DIG. 1, 166, 325; 355/200, 245, 260**

[56] **References Cited**

U.S. PATENT DOCUMENTS

D. 245,761 9/1977 Alseth et al. D18/43
D. 252,557 8/1979 Walker et al. D18/43
4,491,161 1/1985 Tamura et al. 355/260
4,851,873 7/1989 Sakao et al. 355/260

Primary Examiner—Nelson C. Holtje
Assistant Examiner—Caron D. Veynar
Attorney, Agent, or Firm—Jordan and Hamburg

[57] **CLAIM**

The ornamental design for a toner cartridge, as shown.

DESCRIPTION

FIG. 1 is a front elevational view of a toner cartridge showing my new design;

FIG. 2 is a rear elevational view thereof;

FIG. 3 is a top plan view thereof;

FIG. 4 is a bottom plan view thereof;

FIG. 5 is a left side elevational view thereof;

FIG. 6 is a right side elevational view thereof; and

FIG. 7 is a right front perspective view thereof.

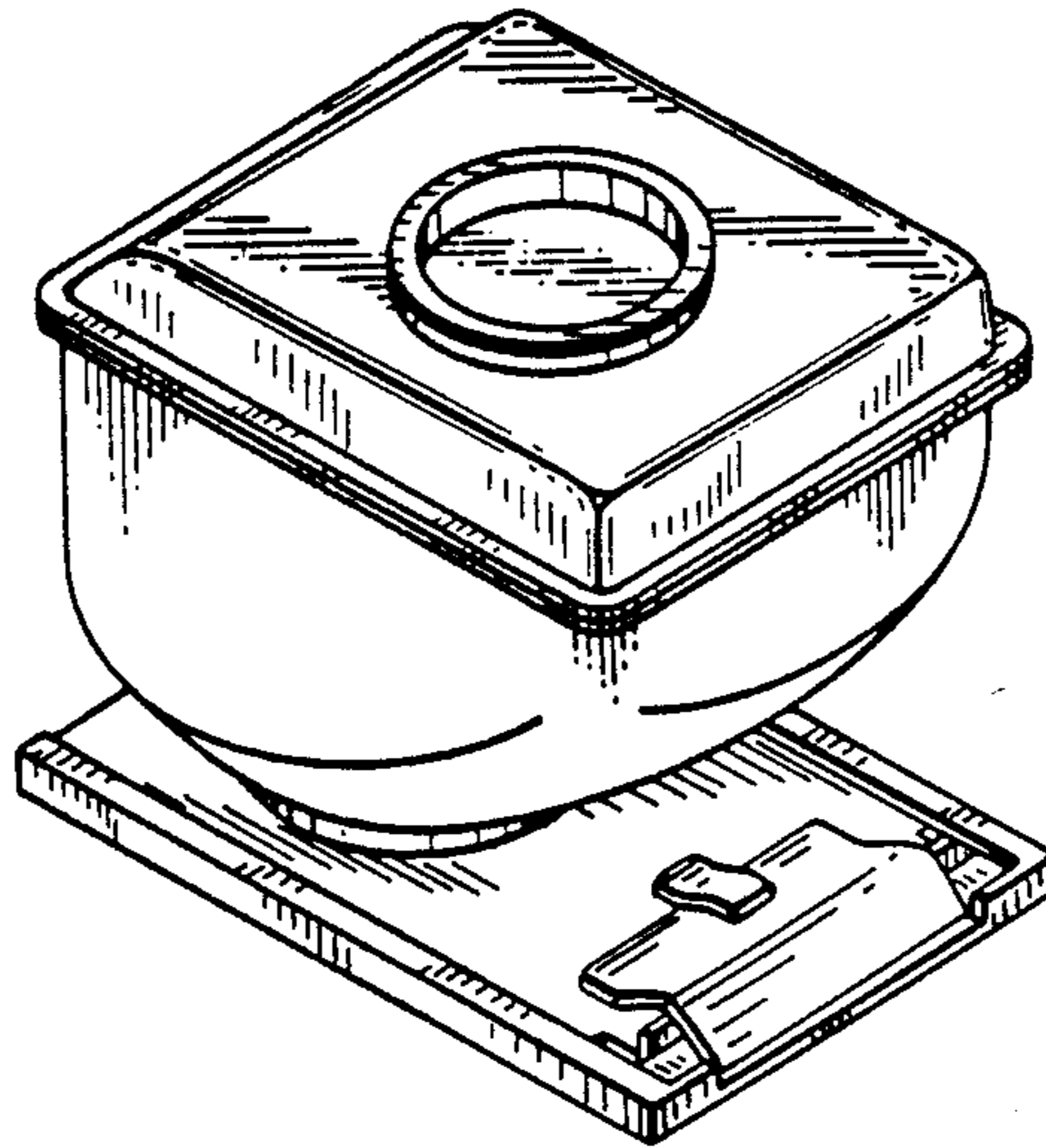

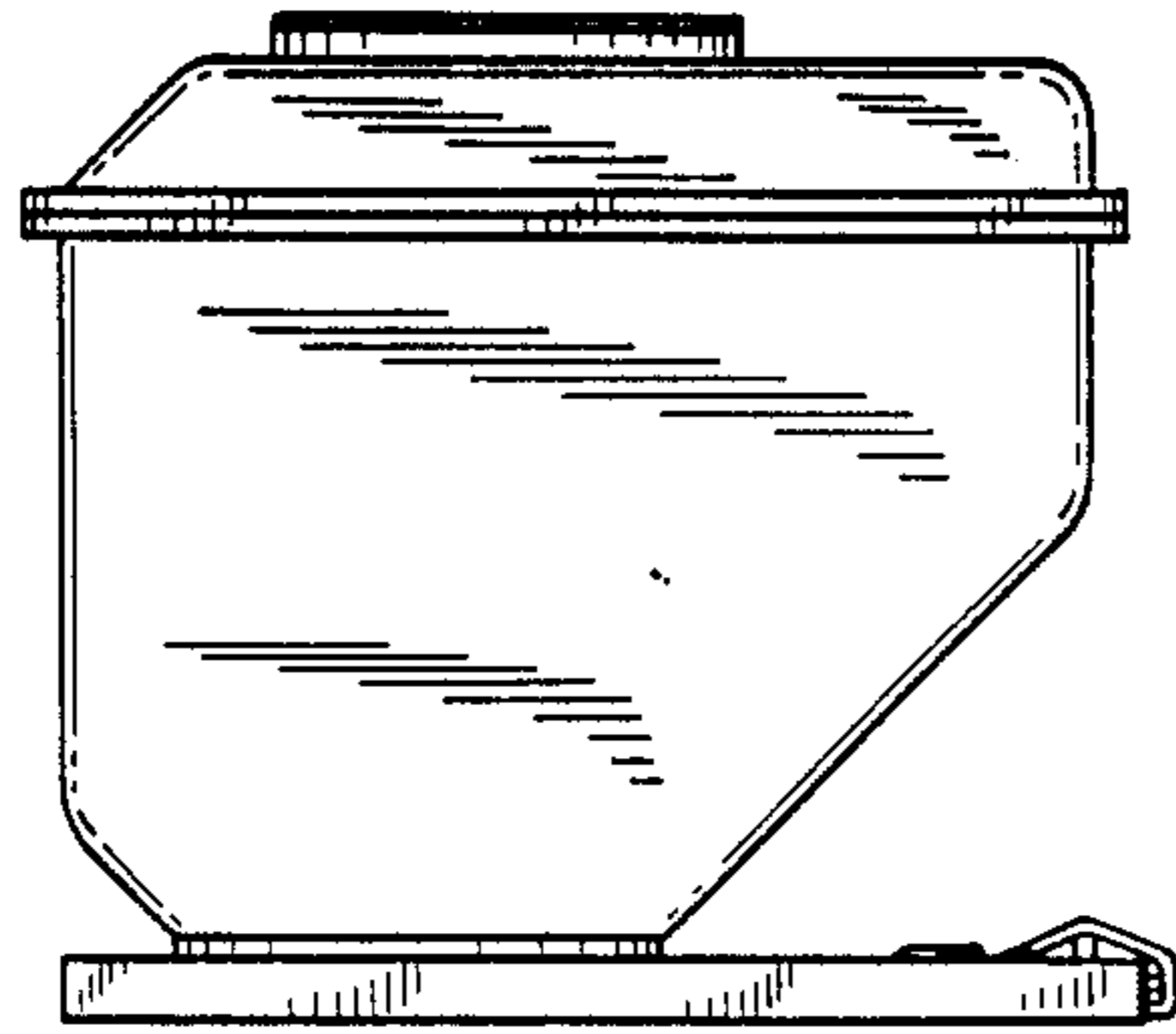

FIG. 1

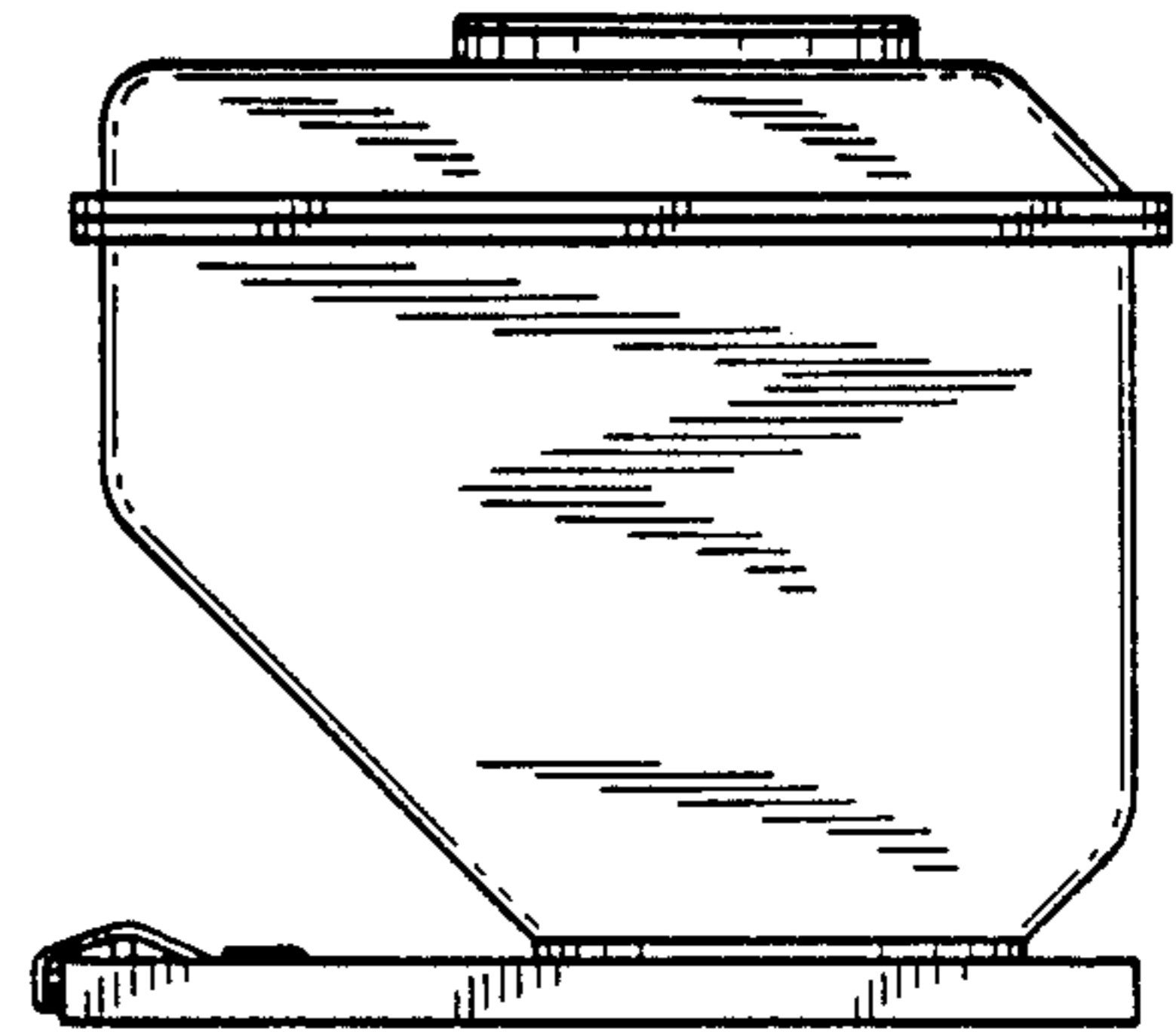

FIG. 2

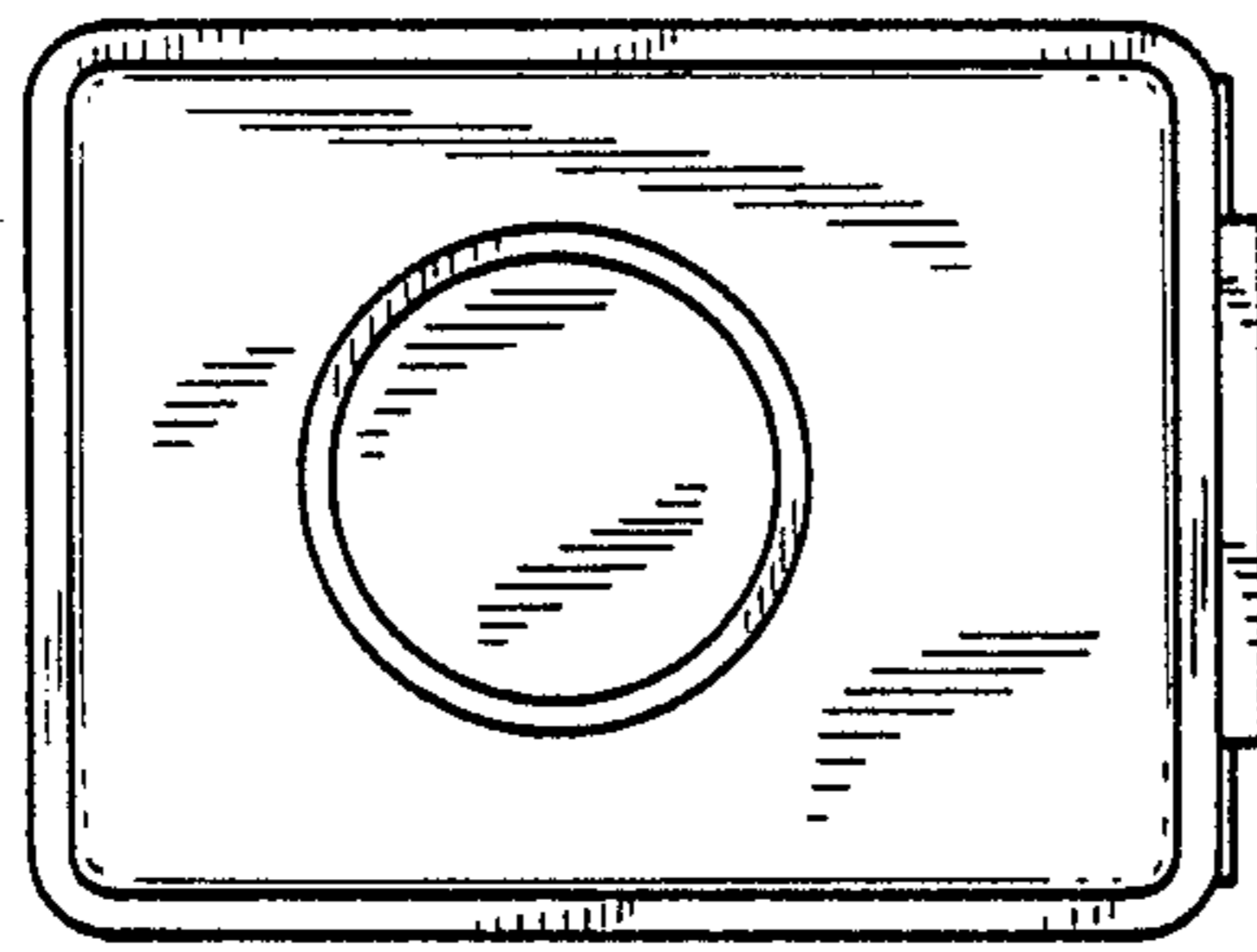

FIG. 3

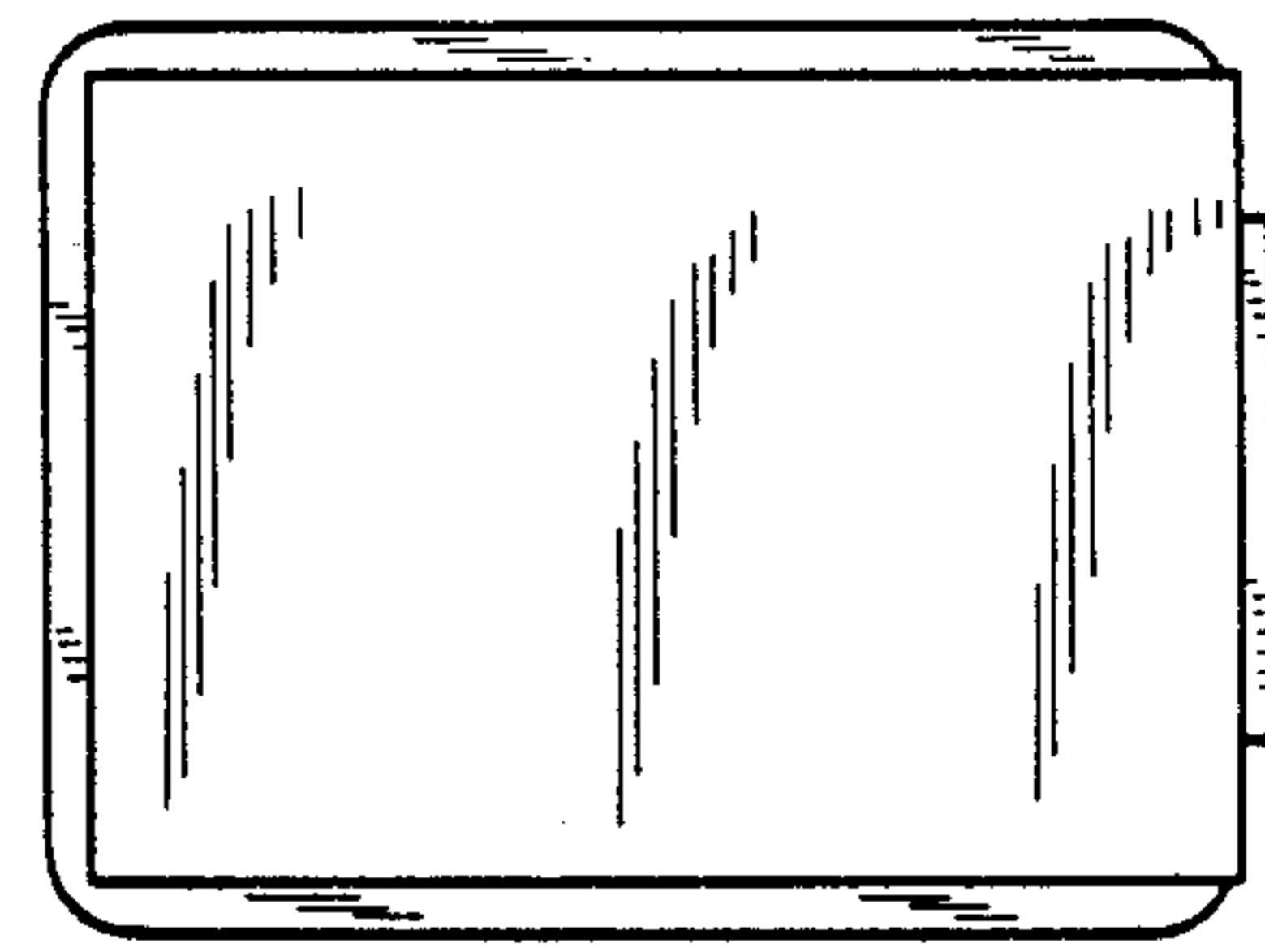

FIG. 4

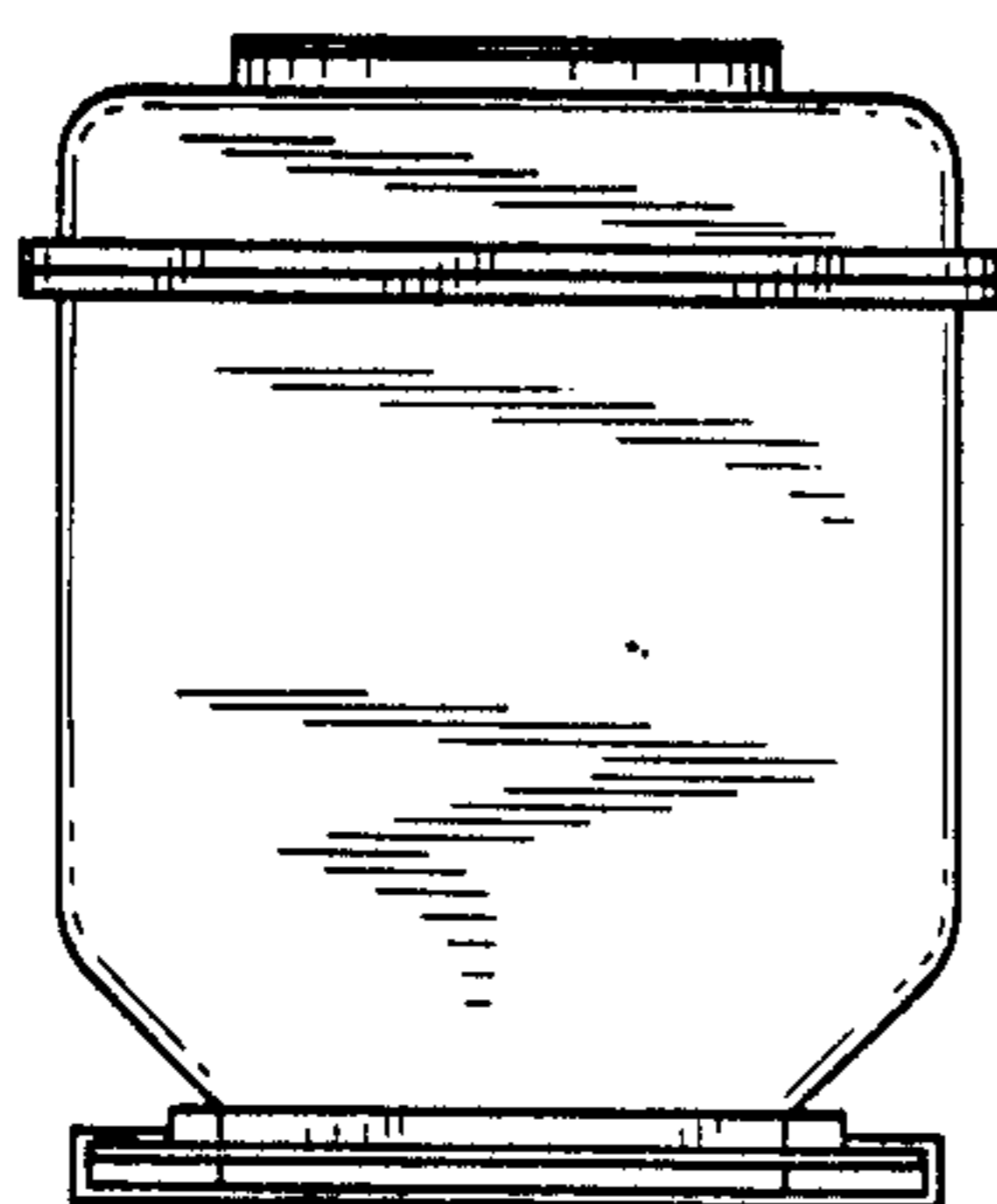

FIG. 5

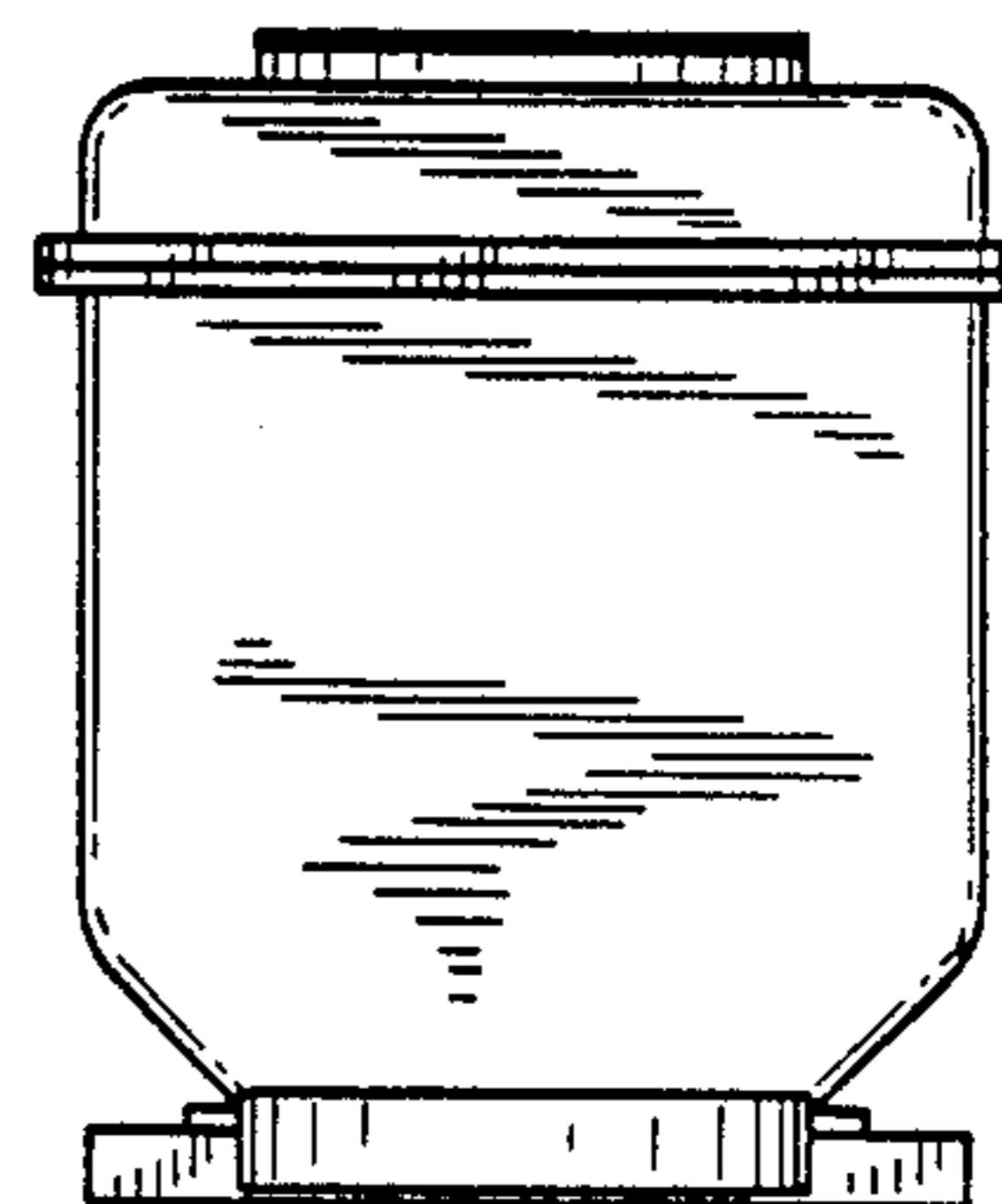

FIG. 6

FIG. 7

