

[54] SCARF SLIDE

[76] Inventor: Josette Boivin, 50-52 rue de la Saussière, 92100 Boulogne S/Seine, France

[**] Term: 14 Years

[21] Appl. No.: 187,433

[22] Filed: Apr. 28, 1988

[52] U.S. Cl. D11/202

[58] Field of Search D11/202-205, D11/26, 35, 38; 63/1.1, 18

[56] References Cited

U.S. PATENT DOCUMENTS

D. 83,453 2/1931 Krasnow D11/38

152,066 6/1874 Brainerd 68/18
D. 256,403 8/1980 Hocq D11/202

Primary Examiner—Louis S. Zarfes
Assistant Examiner—R. T. Seifert
Attorney, Agent, or Firm—Kuhn and Muller

[57] CLAIM

The ornamental design for a scarf slide, as shown.

DESCRIPTION

FIG. 1 is a front elevational view of a scarf slide showing my new design;
FIG. 2 is a rear elevational view;
FIG. 3 is a right side elevational view;
FIG. 4 is a top plan view;
FIG. 5 is a bottom plan view; and
FIG. 6 is a left side elevational view.

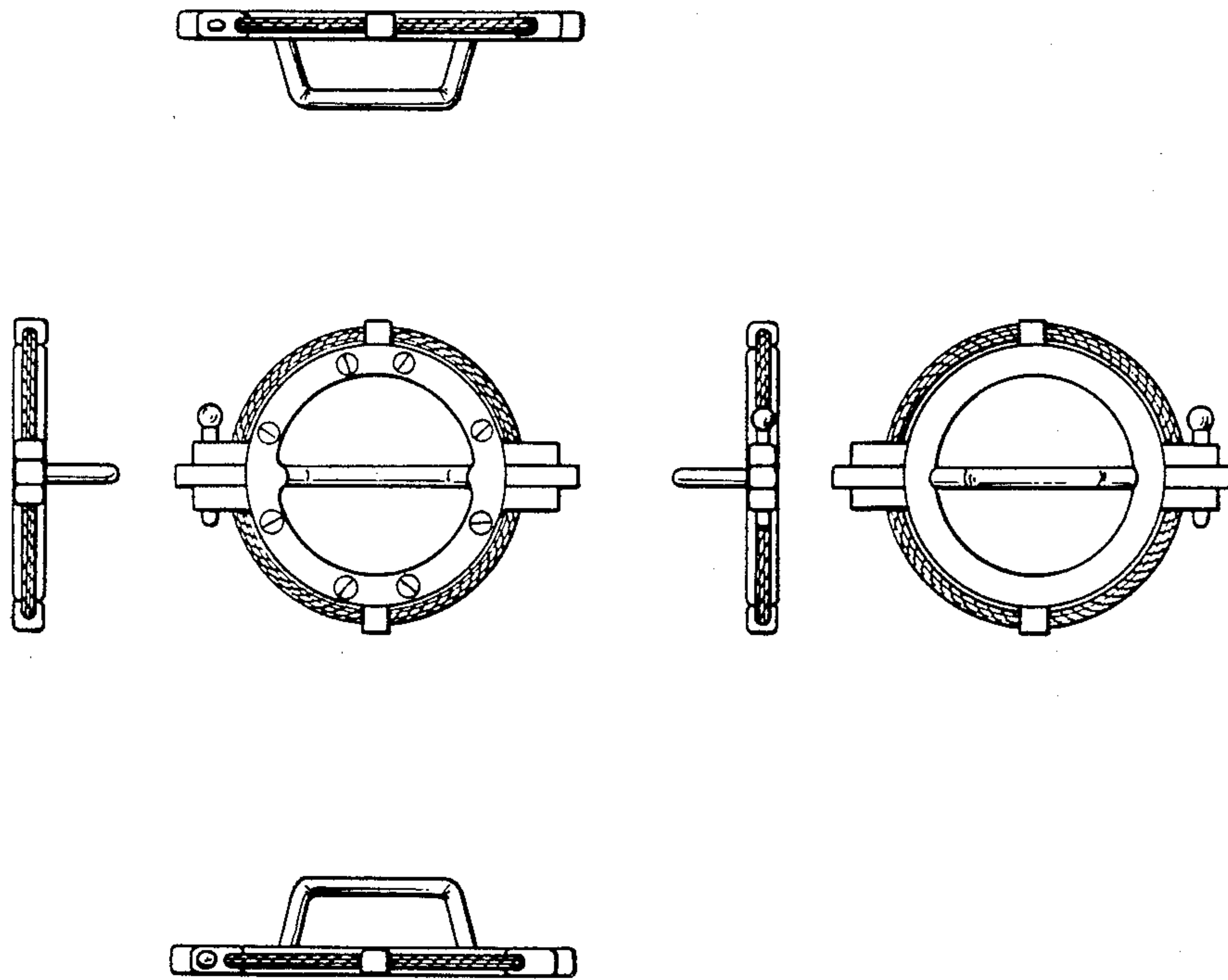

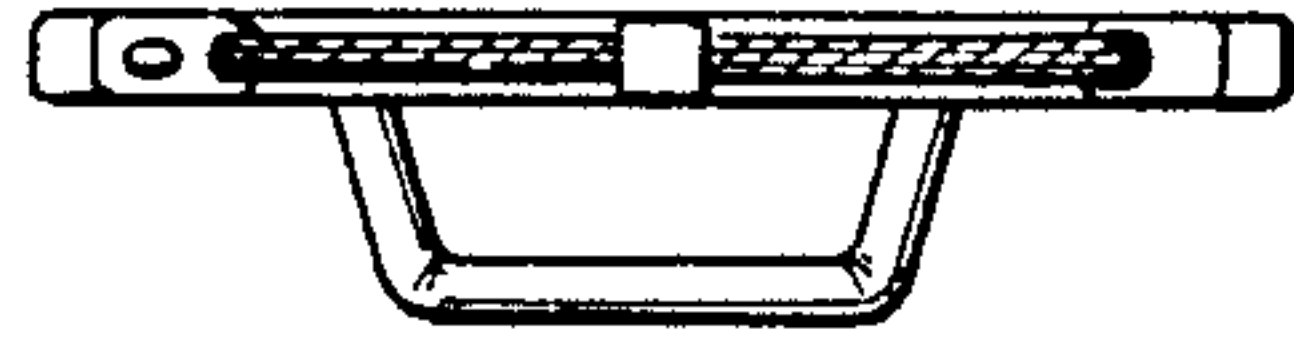

FIG. 5

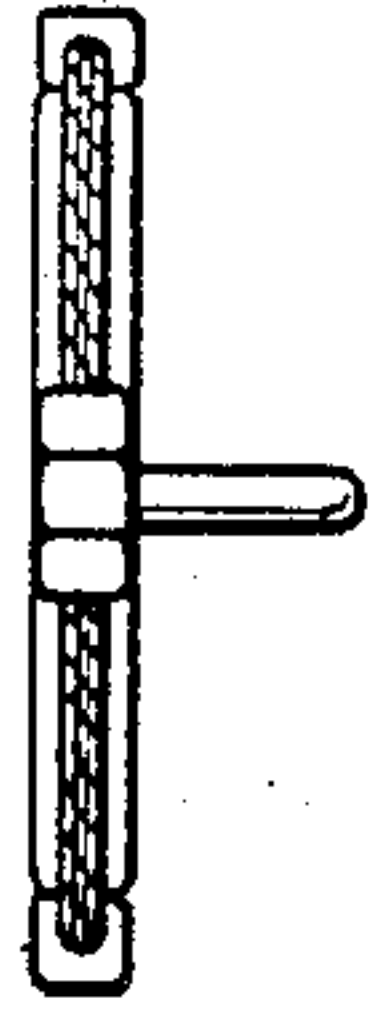

FIG. 3

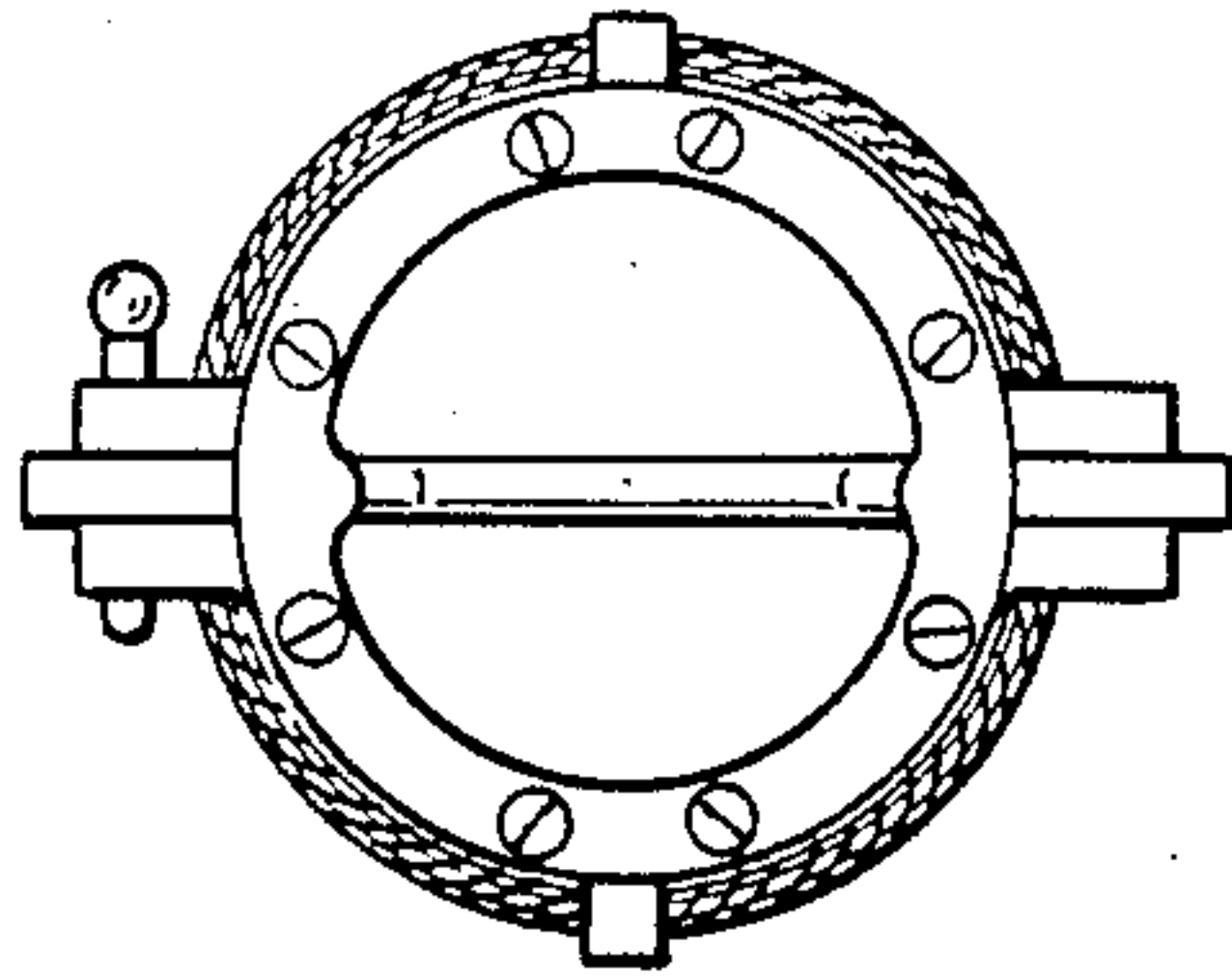

FIG. 1

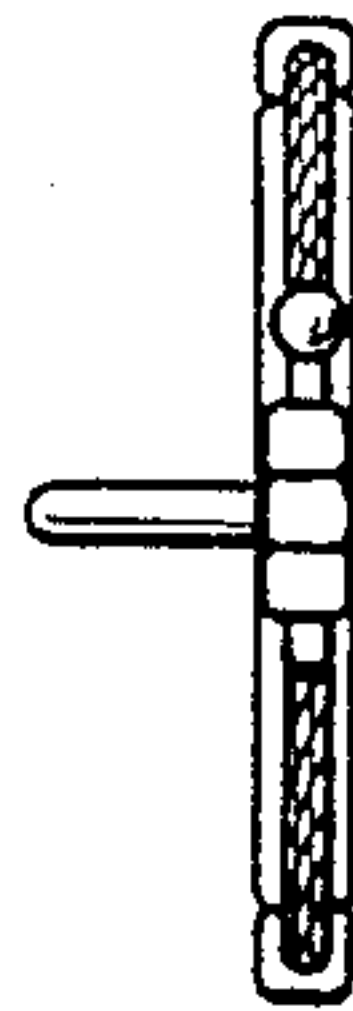

FIG. 6

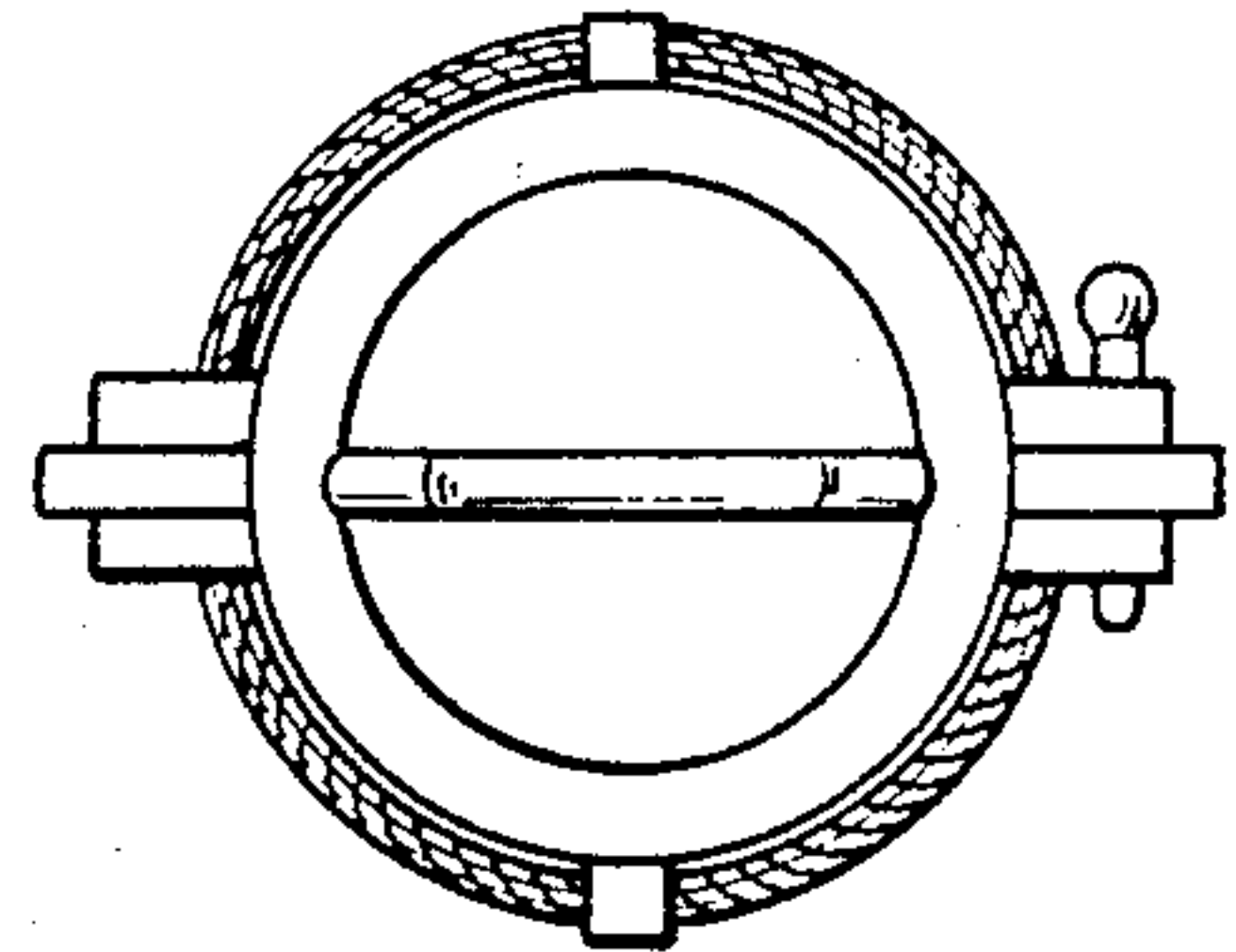

FIG. 2

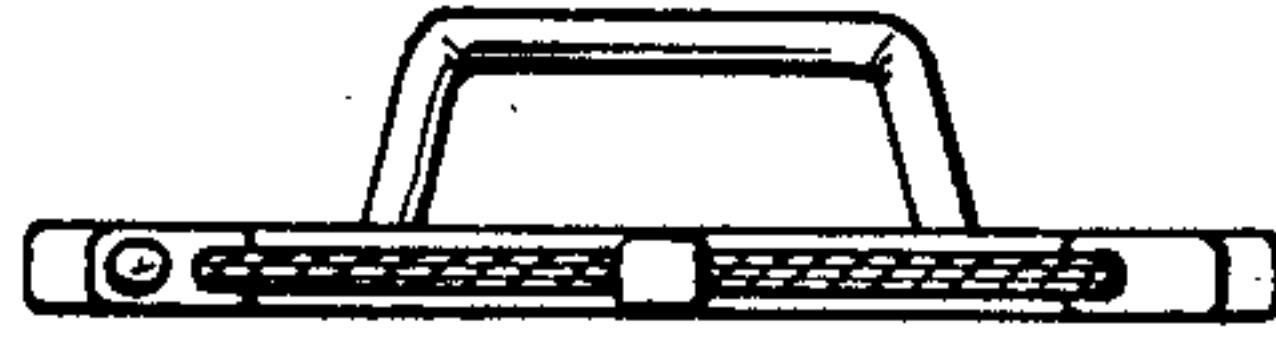

FIG. 4