

[54] BATTERY POWERED LAMP

[75] Inventor: David K. Stearns, Derby, Kans.

[73] Assignee: Coleman Outdoor Products, Inc.,
Wichita, Kans.

[**] Term: 14 Years

[21] Appl. No.: 140,423

[22] Filed: Jan. 4, 1988

[52] U.S. Cl. D26/110

[58] Field of Search D26/93, 102-112;
362/410-414, 806

[56] References Cited

U.S. PATENT DOCUMENTS

- D. 50,335 2/1917 Barrows et al. D26/110
- D. 76,347 9/1928 KannéD26 110/
- D. 237,534 11/1975 Jacobsen D26/108

D. 268,055 2/1983 Moore D26/112

Primary Examiner—Susan J. Lucas

[57] CLAIM

The ornamental design for a battery powered lamp, as shown and described.

DESCRIPTION

FIG. 1 is a front, left side perspective view of a battery powered lamp showing my new design, the front, right side view being a mirror image;

FIG. 2 is a rear perspective view thereof;

FIG. 3 is a front, left side perspective view thereof, with the shade removed for purposes of disclosure;

FIG. 4 is a front elevational view thereof, the rear elevational view being identical except for the omission of the switch;

FIG. 5 is a top plan view thereof;

FIG. 6 is a bottom plan view thereof.

The oblique lines on the shade indicate translucency.

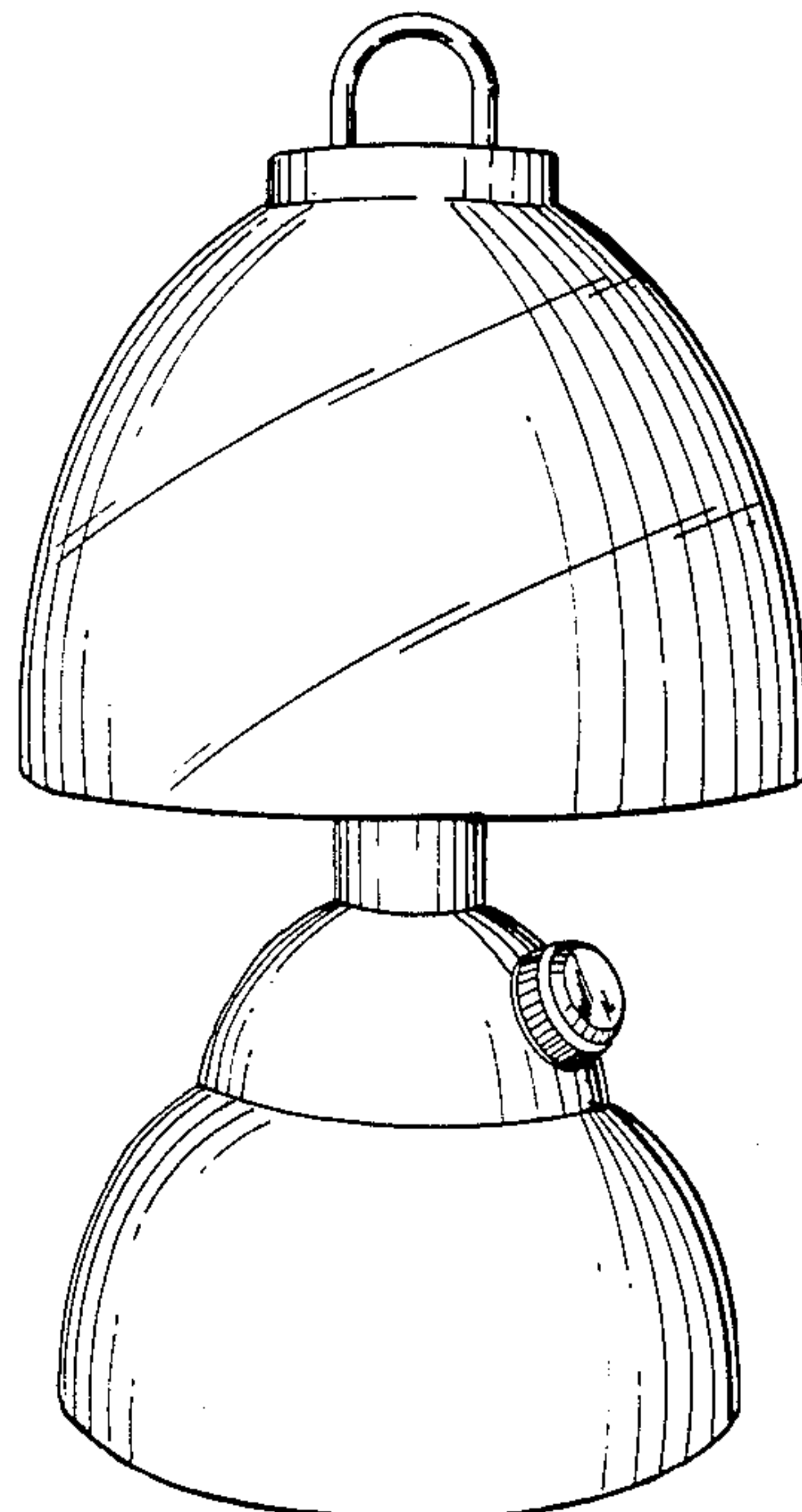

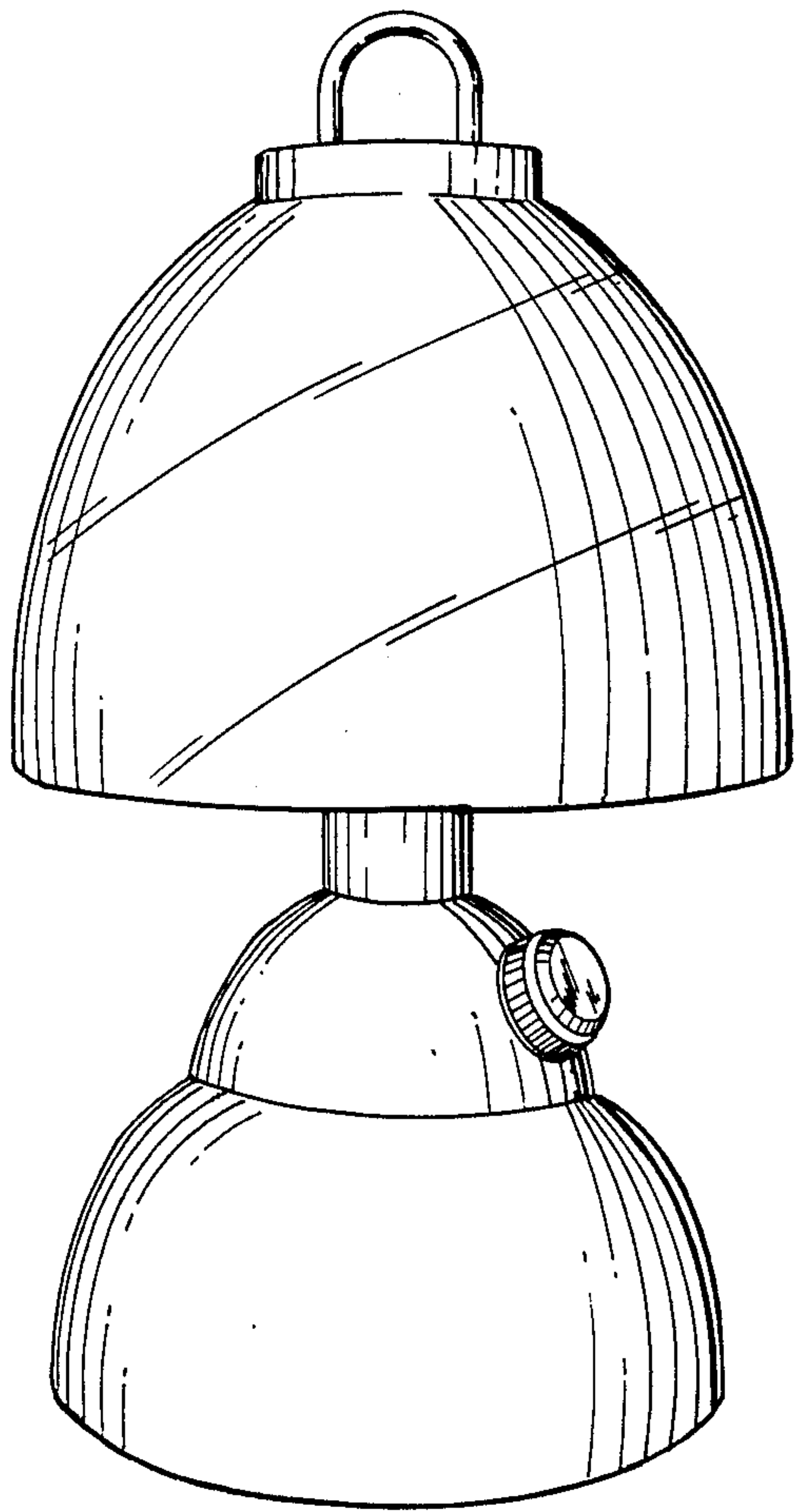

FIG. 1

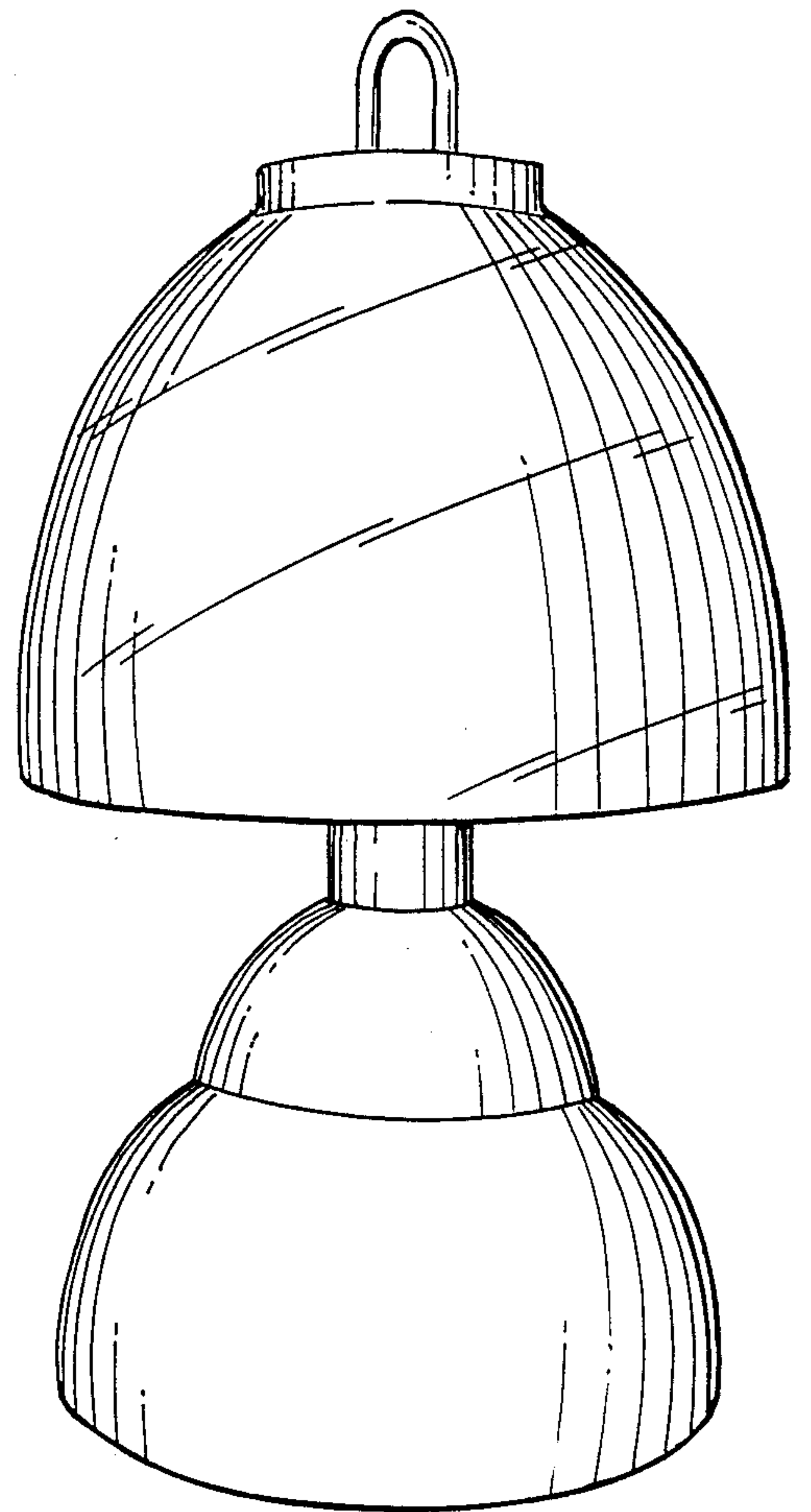

FIG. 2

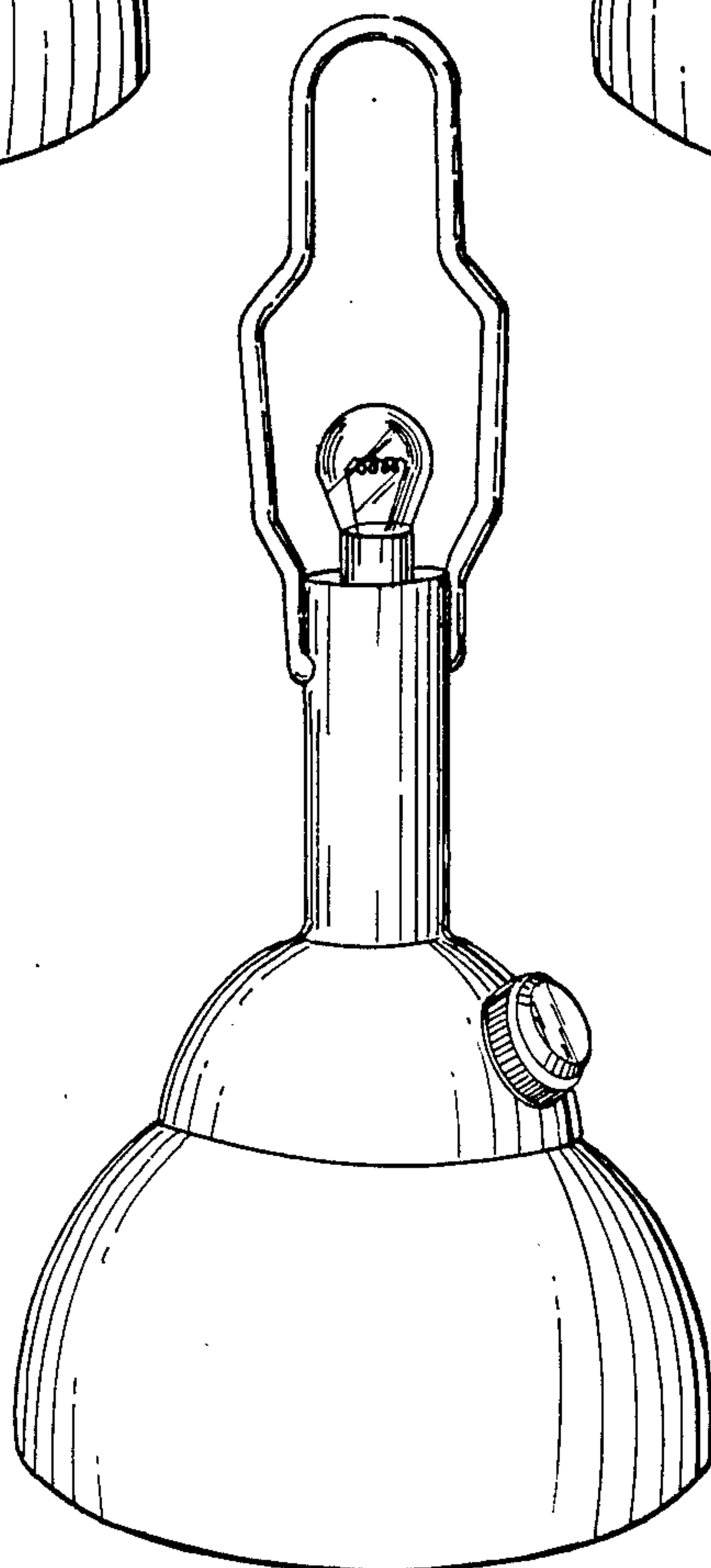

FIG. 3

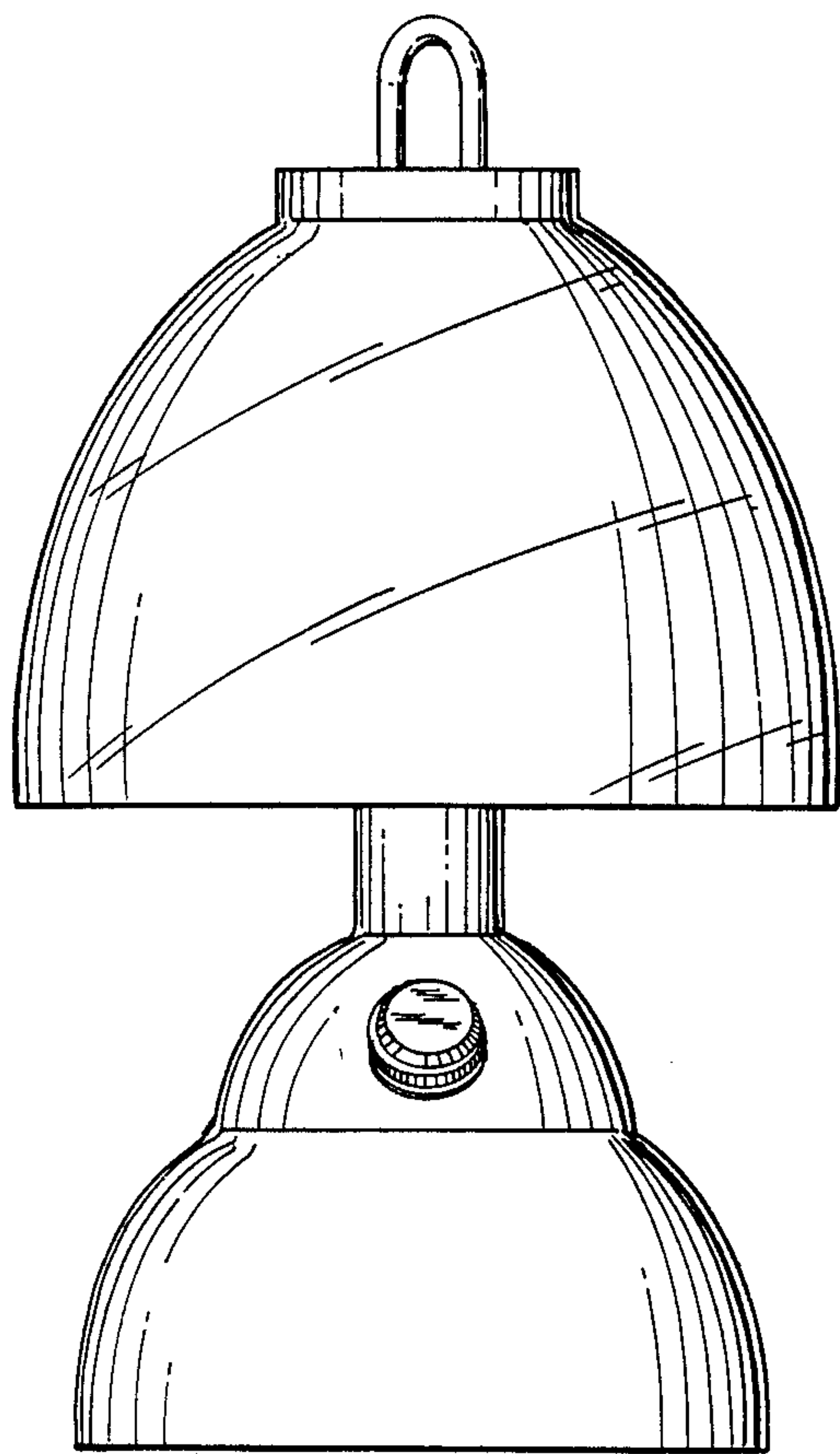

FIG. 4

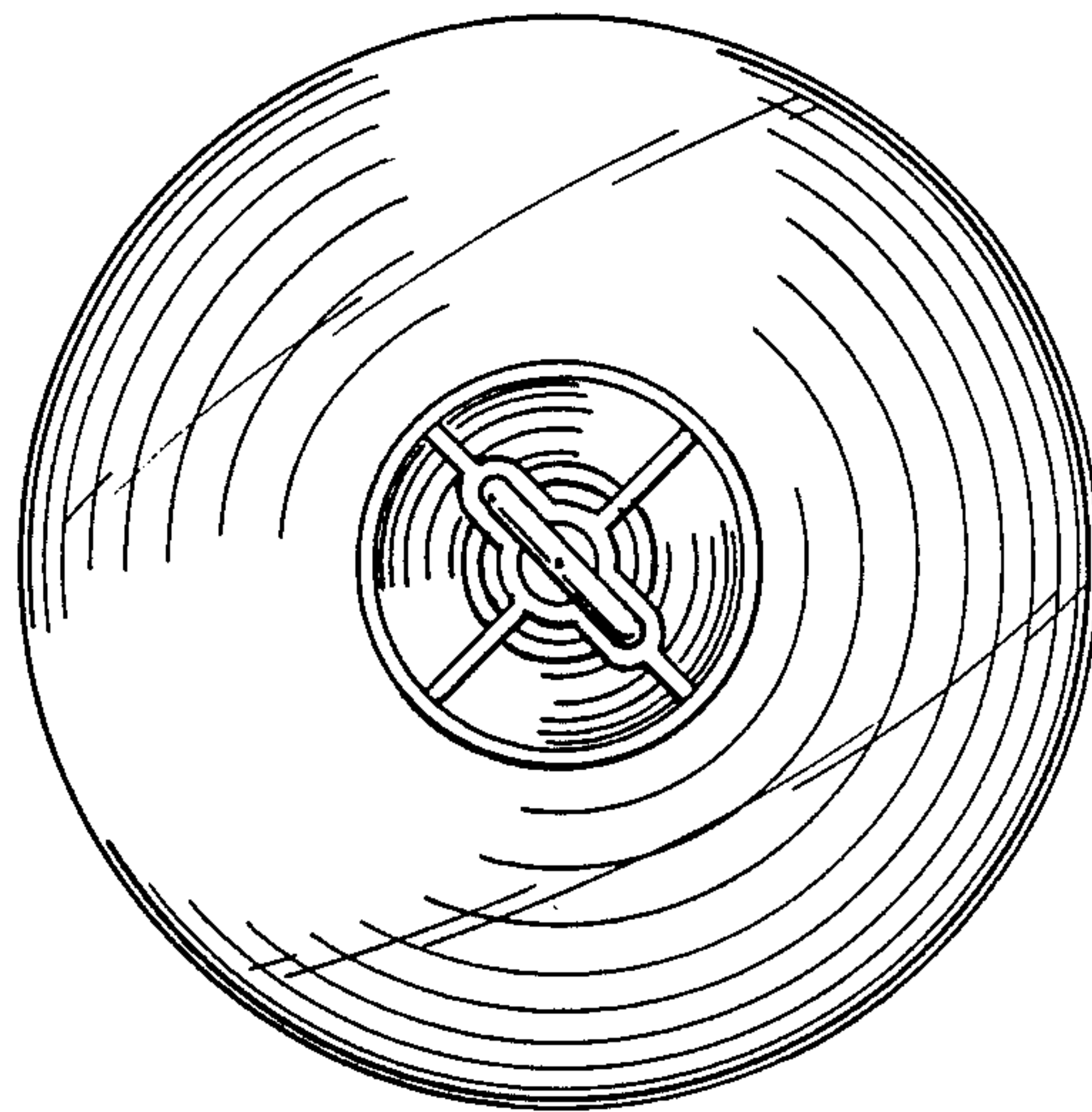

FIG. 5

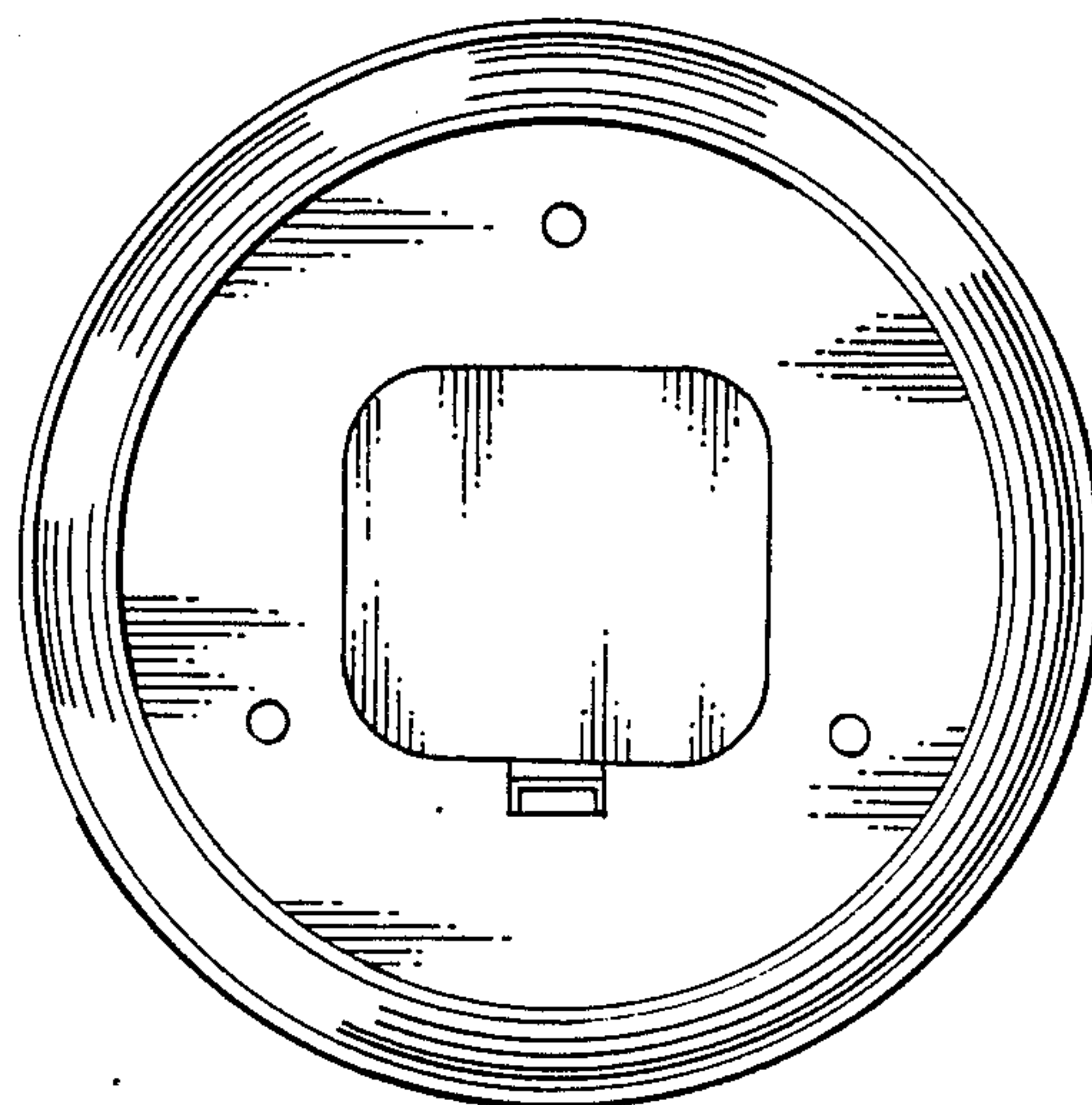

FIG. 6