

[54] TAPE APPLICATOR

[75] Inventor: Abner Berracasa, Pully, Switzerland

[73] Assignee: Capitol Trading S.A., Lausanne, Switzerland

[**] Term: 14 Years

[21] Appl. No.: 48,121

[22] Filed: May 11, 1987

[30] Foreign Application Priority Data

Nov. 21, 1986 [CH] Switzerland 115,573
[52] U.S. Cl. D19/69; D19/67
[58] Field of Search D19/67, 68, 69; 83/167, 83/560, 467, 588, 618; 225/6, 19, 45, 56, 65, 77, 85, 89

[56] References Cited

U.S. PATENT DOCUMENTS

D. 53,938 10/1919 Shanklin D19/67 X
D. 157,219 2/1950 Vavrik D19/68
D. 280,738 9/1985 Grassi D19/68

D. 286,414 10/1986 Pappalardo D19/68 X
D. 298,339 11/1988 Eisenberg et al. D19/67
D. 300,151 3/1989 Lin D19/67
2,582,979 1/1952 Fritzinger D19/69

Primary Examiner—Bruce W. Dunkins
Assistant Examiner—Martha K. Thompson
Attorney, Agent, or Firm—Anthony J. Casella; Gerald E. Hespos

[57] CLAIM

The ornamental design for tape applicator, as shown.

DESCRIPTION

FIG. 1 is a left side elevational view of a tape applicator showing my design, the spool member being depicted in broken lines for convenience of illustration; FIG. 2 is a top plan view; FIG. 3 is an end elevational view taken from the right end of FIG. 1; FIG. 4 is an end elevational view taken from the left end of FIG. 1; FIG. 5 is a bottom plan view; FIG. 6 is a right side elevational view; and FIG. 7 is a left side elevational view thereof.

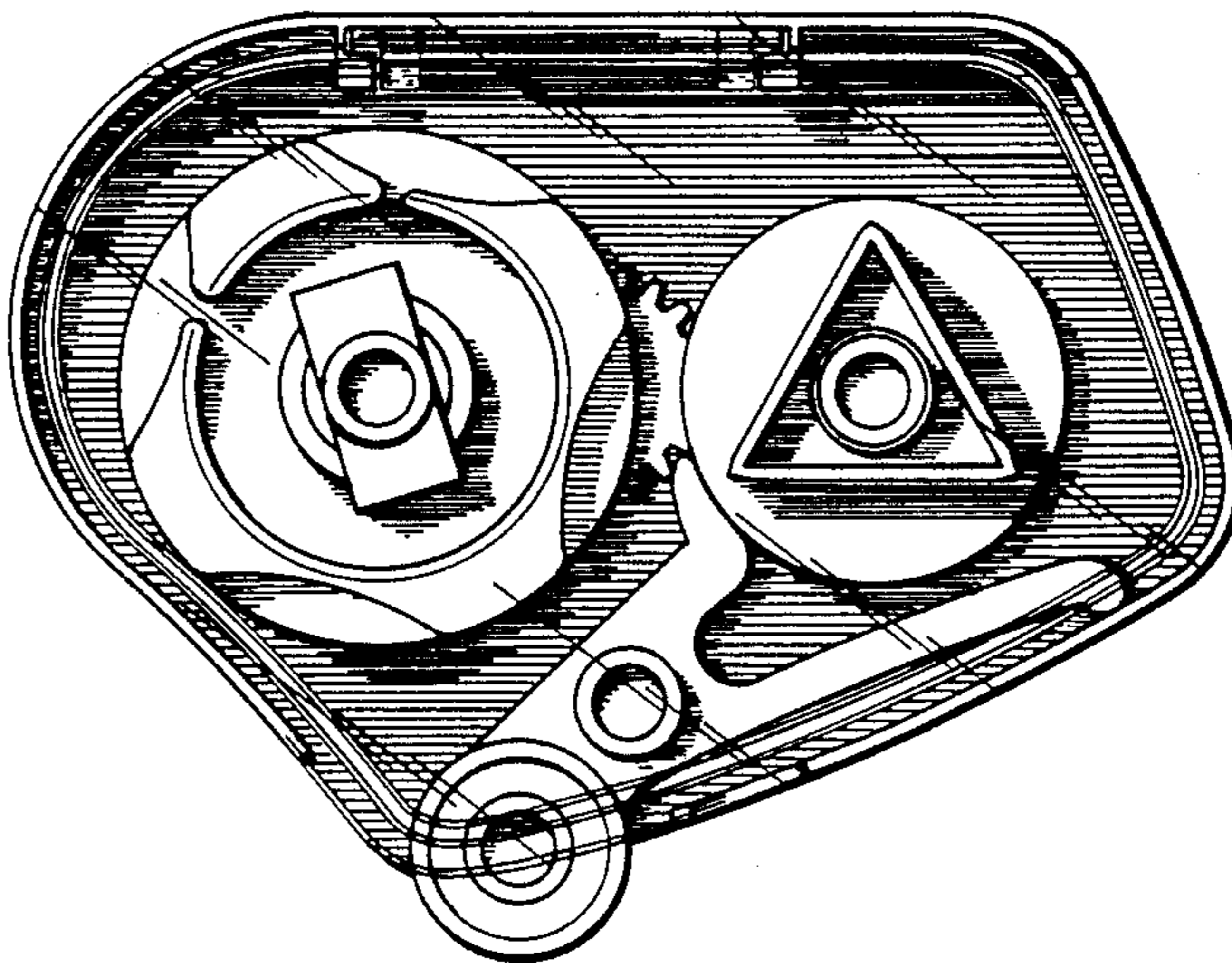

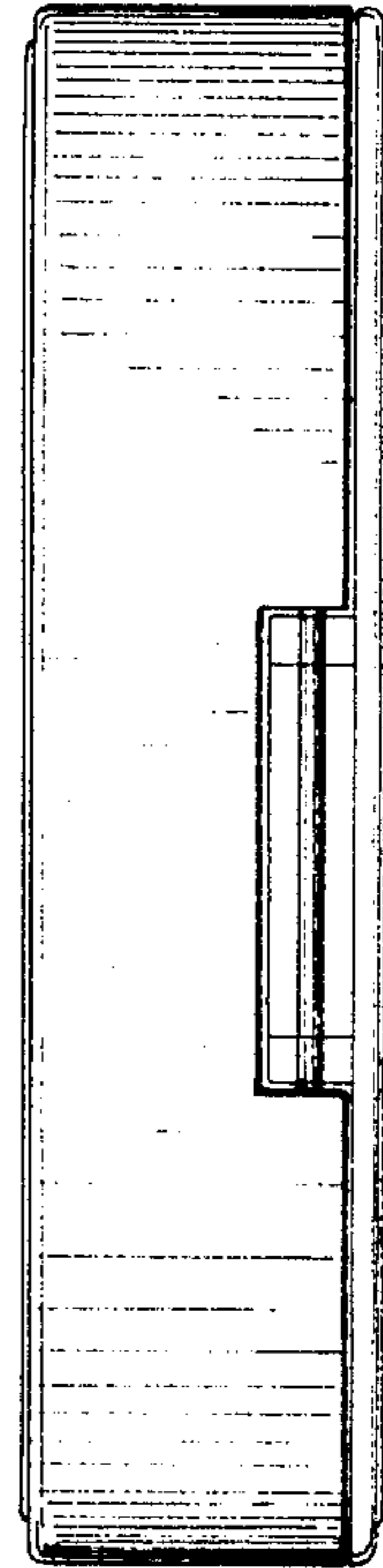
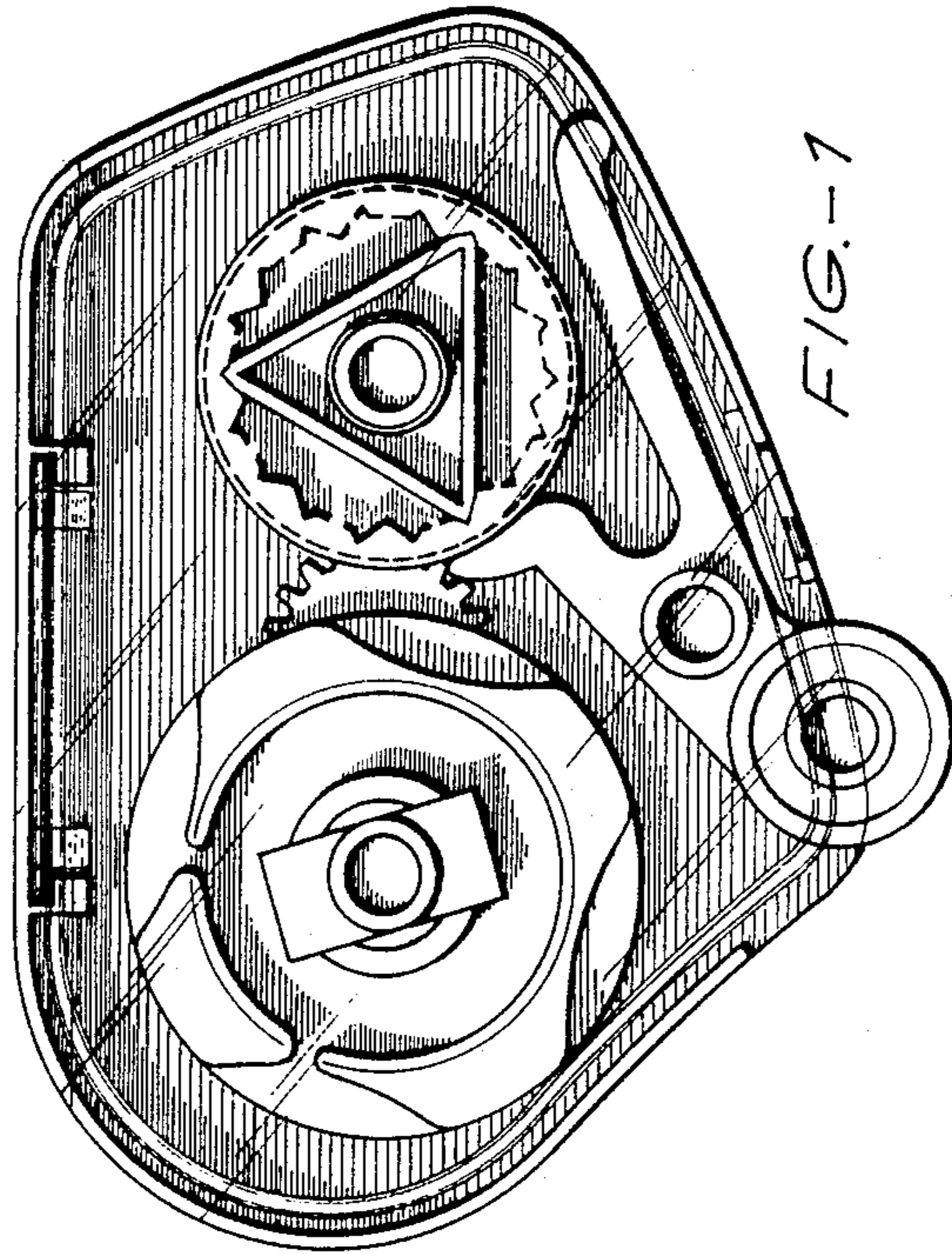
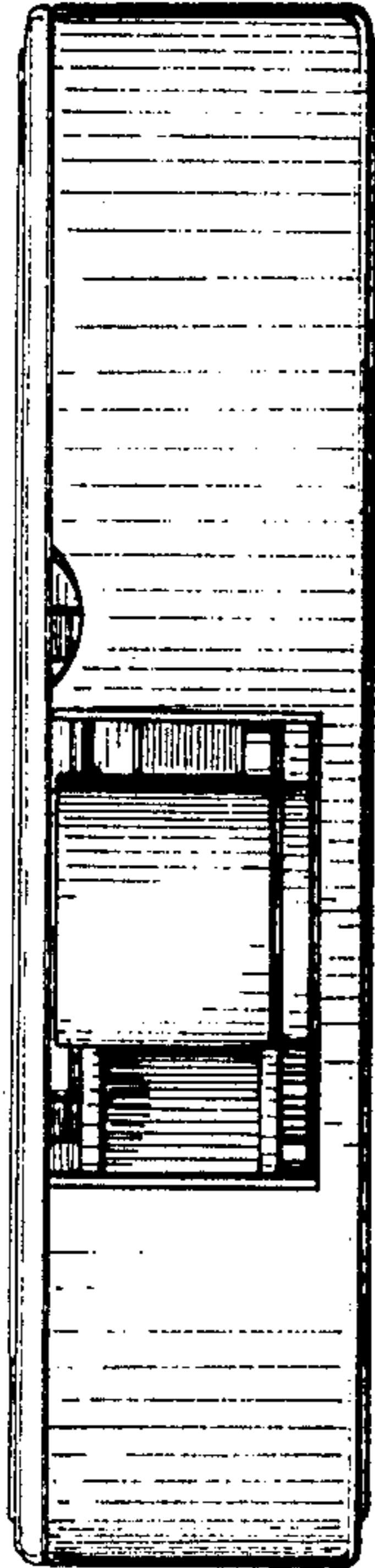
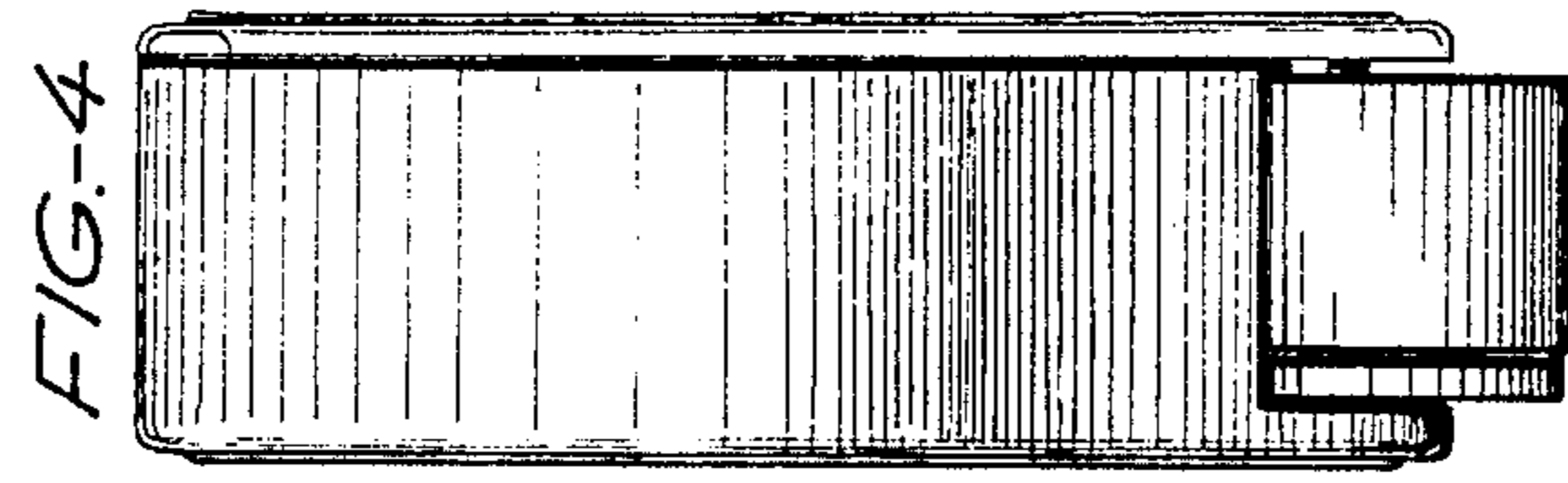

FIG.-5

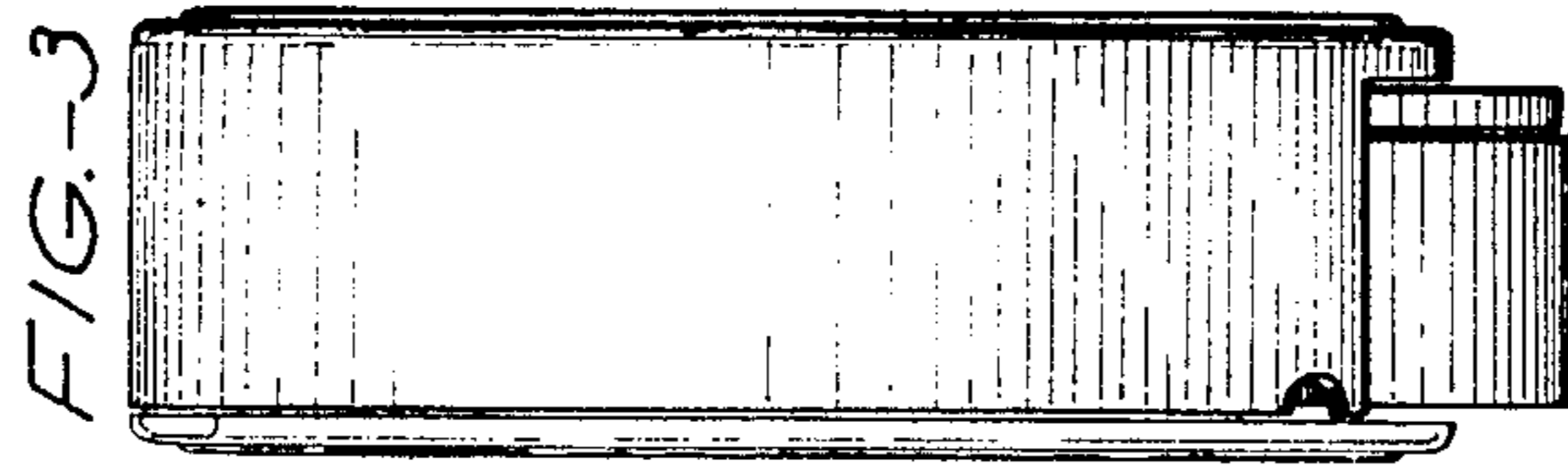

FIG.-2

FIG.-3

FIG.-7

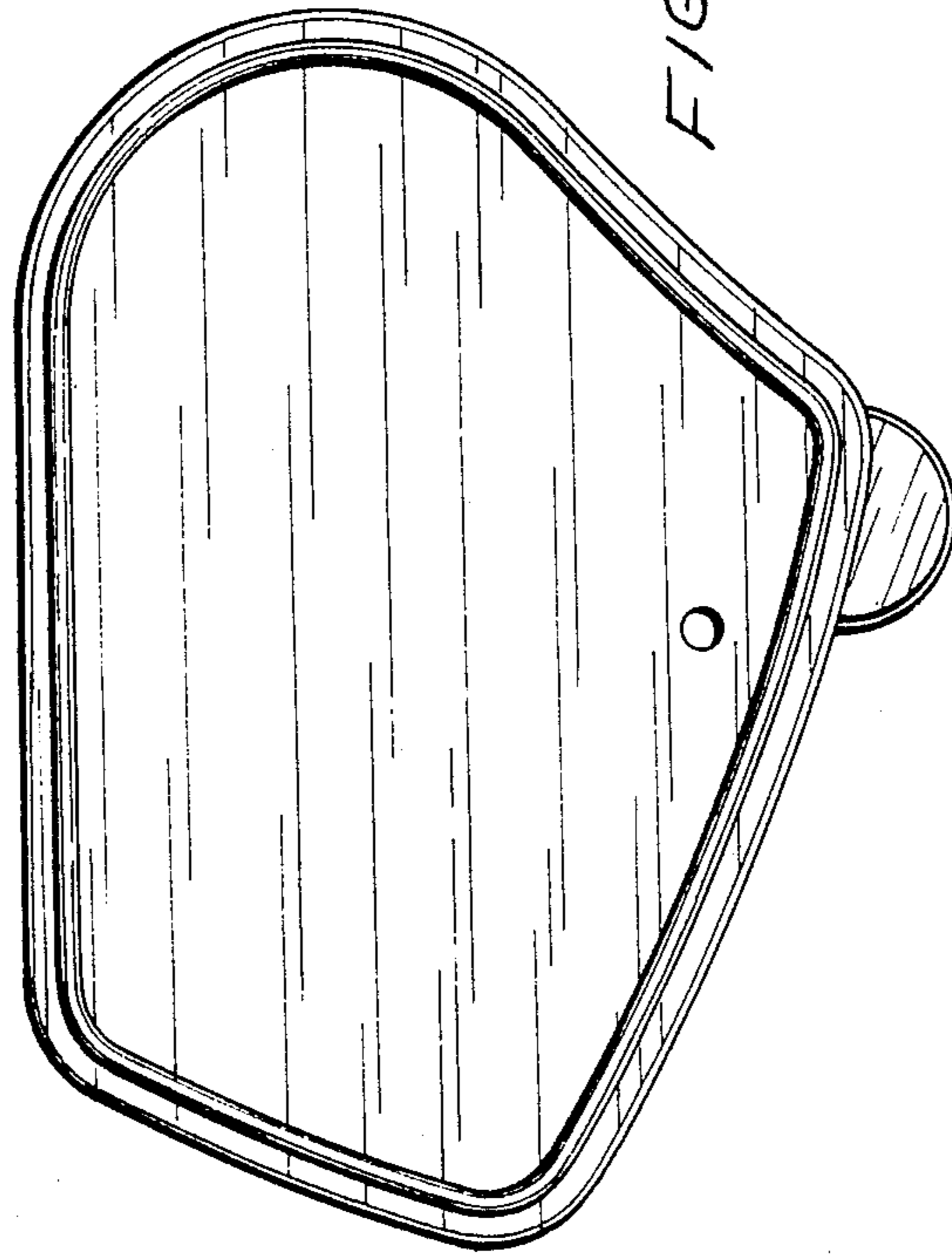

FIG.-6

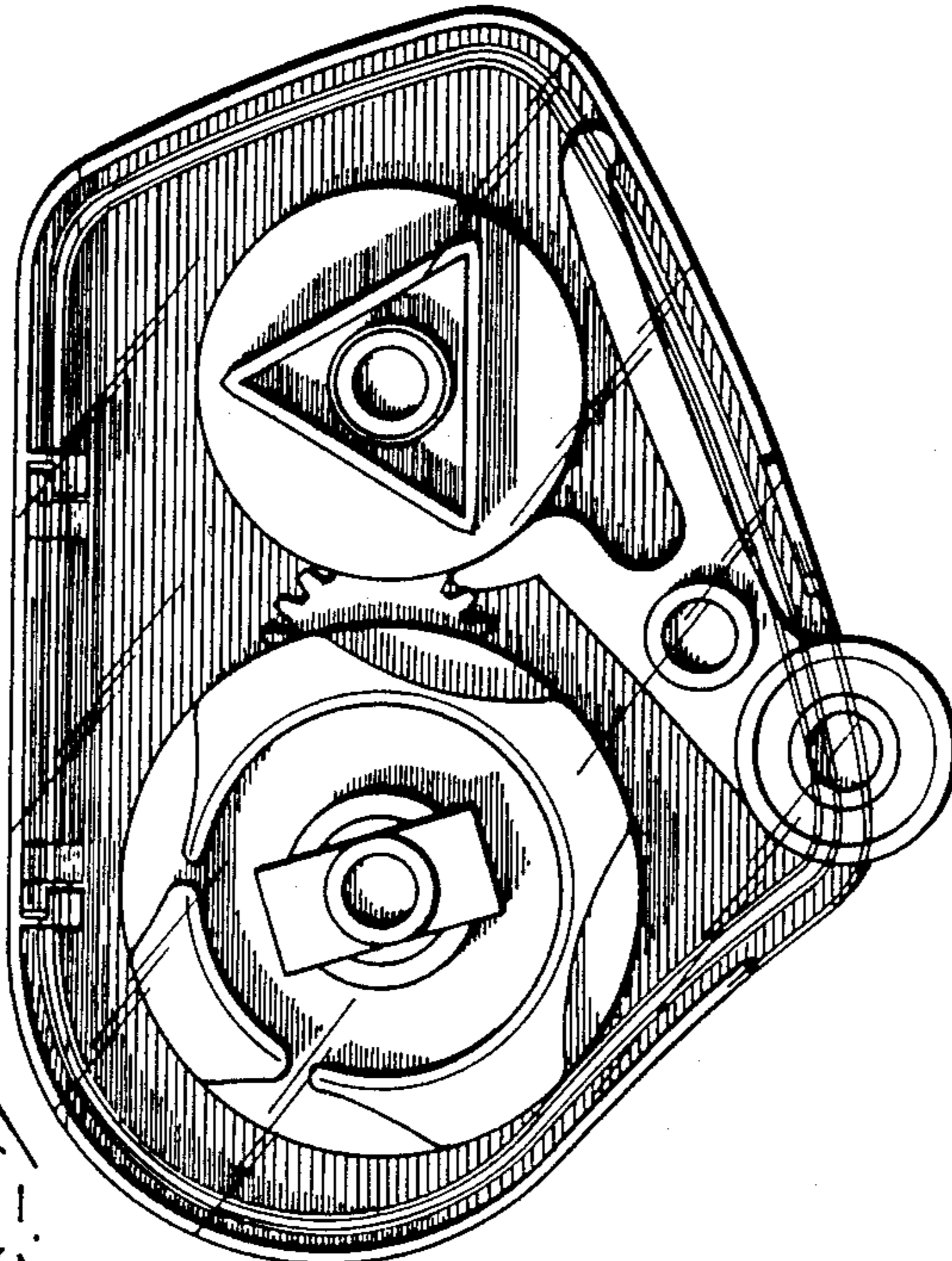

FIG.-7