

[54] NOZZLE TIP FOR A DISPENSER OF SEALANT OR ADHESIVE

[75] Inventors: Dave E. Schultz, South Bend; Ron F. Riede, Granger, both of Ind.

[73] Assignee: Uniroyal Plastics Company, Inc., Mishawaka, Ind.

[\*\*] Term: 14 Years

[21] Appl. No.: 116,137

[22] Filed: Nov. 2, 1987

[52] U.S. Cl. .... D9/447

[58] Field of Search ..... D9/385, 373, 375, 435, D9/442, 447, 449, 438, 436, 434; 222/545, 207, 531, 537, 548, 551, 480, 528, 534, 565, 566-577; 206/307, 309, 387; 215/304, 307, 355

[56] References Cited

U.S. PATENT DOCUMENTS

D. 136,098	8/1943	Hartman, Sr. ....	D9/447
D. 239,599	4/1976	Carroll .....	D9/434
3,002,240	10/1961	Laguerre .....	D9/435
4,202,334	5/1980	Elson .....	215/355

OTHER PUBLICATIONS

Brochure, Semco Division-Products Research & Chemical Corp. (Jul. 1987).

Primary Examiner—Louis S. Zarfaz

Assistant Examiner—R. T. Seifert  
Attorney, Agent, or Firm—Pennie & Edmonds

[57] CLAIM

The ornamental design for a nozzle tip for a dispenser of sealant or adhesive, as shown and described.

DESCRIPTION

FIG. 1 is a top plan view of a nozzle tip for a dispenser of sealant or adhesive showing my new design;  
 FIG. 2 is a bottom plan view;  
 FIG. 3 is a rear elevational view;  
 FIG. 4 is a front elevational view;  
 FIG. 5 is a side elevational view;  
 FIG. 6 is an opposite side elevational view of FIG. 5;  
 FIG. 7 is a side elevational view of a nozzle tip for a dispenser of sealant or adhesive showing a second embodiment of my new design;  
 FIG. 8 is an opposite side elevational view of FIG. 7;  
 FIG. 9 is a rear elevational view of FIG. 7;  
 FIG. 10 is a front elevational view of FIG. 7;  
 FIG. 11 is a bottom plan view of FIG. 7;  
 FIG. 12 is a rear elevational view of a nozzle tip for a dispenser of sealant or adhesive showing a third embodiment of my new design;  
 FIG. 13 is a front elevational view of FIG. 12; and  
 FIG. 14 is a top plan view of FIG. 12.

The bottom plan view, side elevational view, and opposite side elevational view for the third embodiment would be the same as shown in FIGS. 2, 5 and 6, respectively.

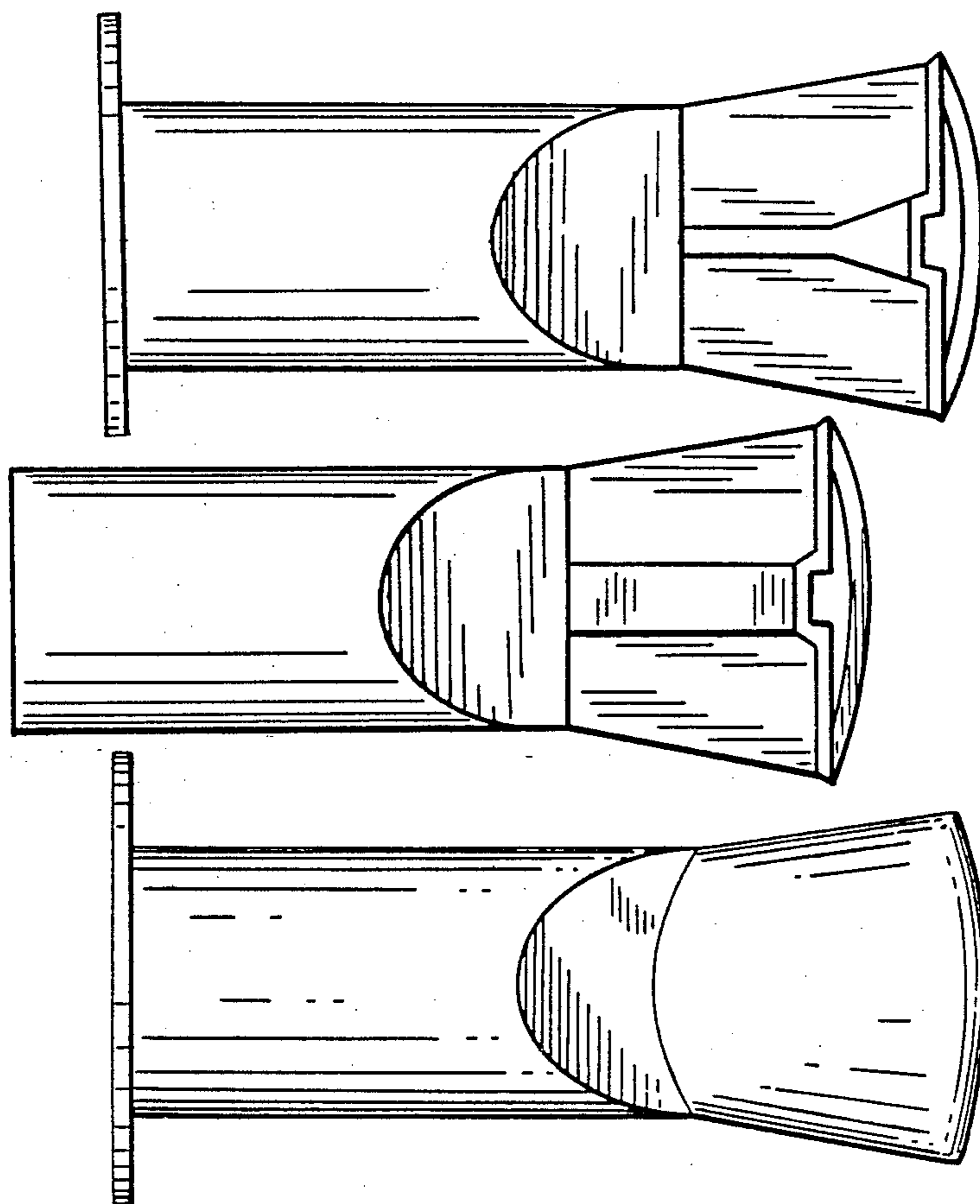

FIG. 1

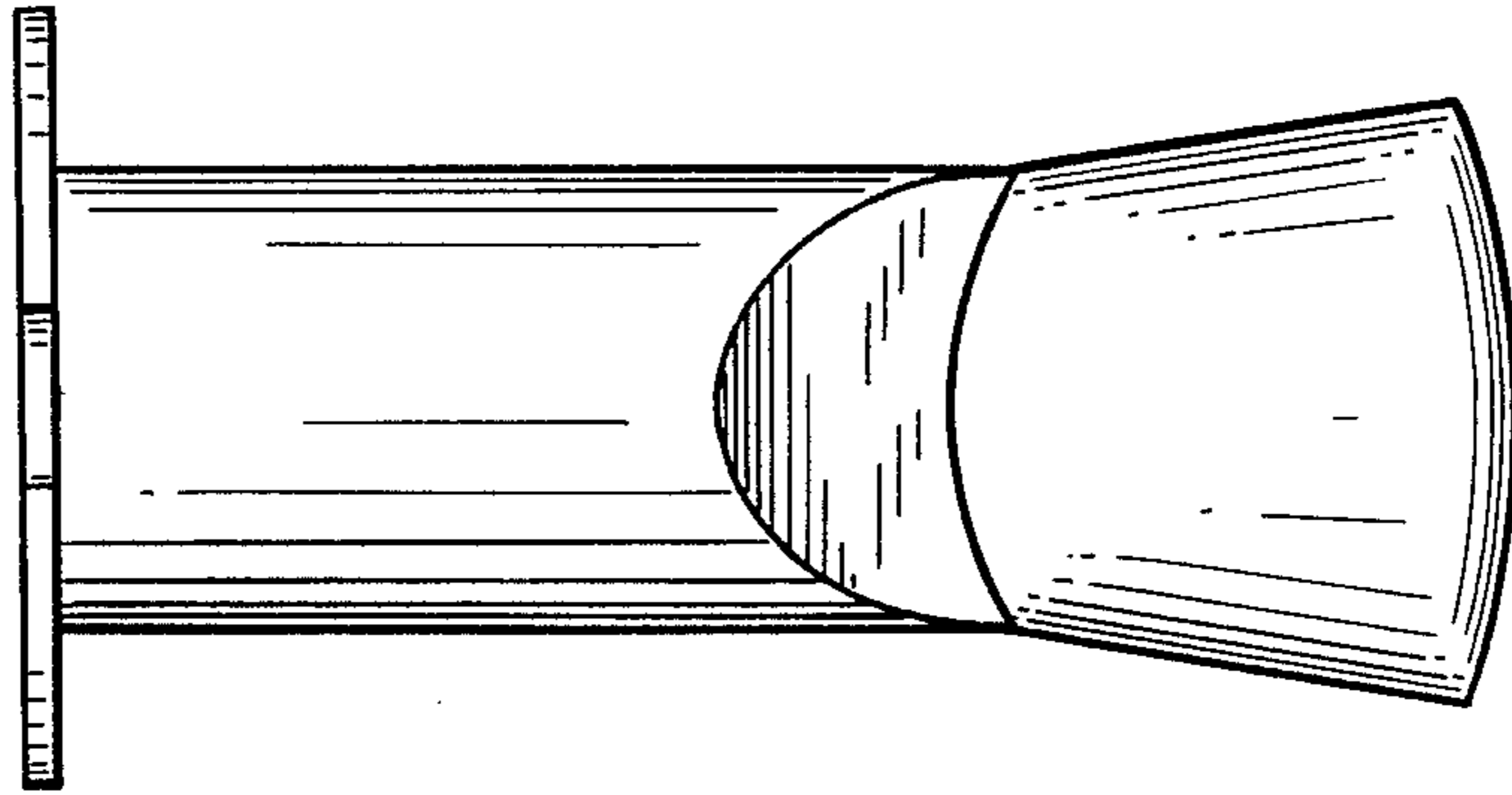

FIG. 2

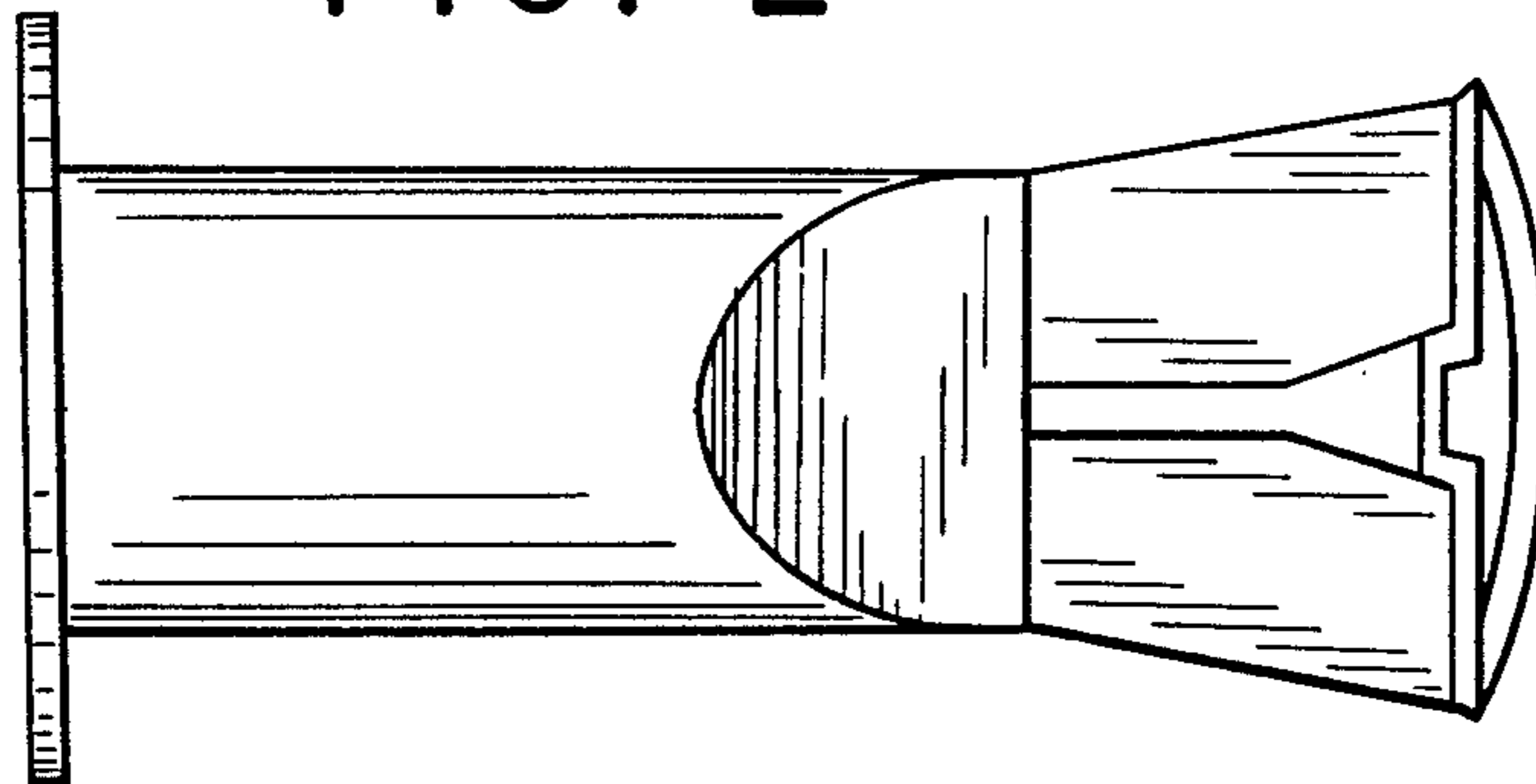

FIG. 3

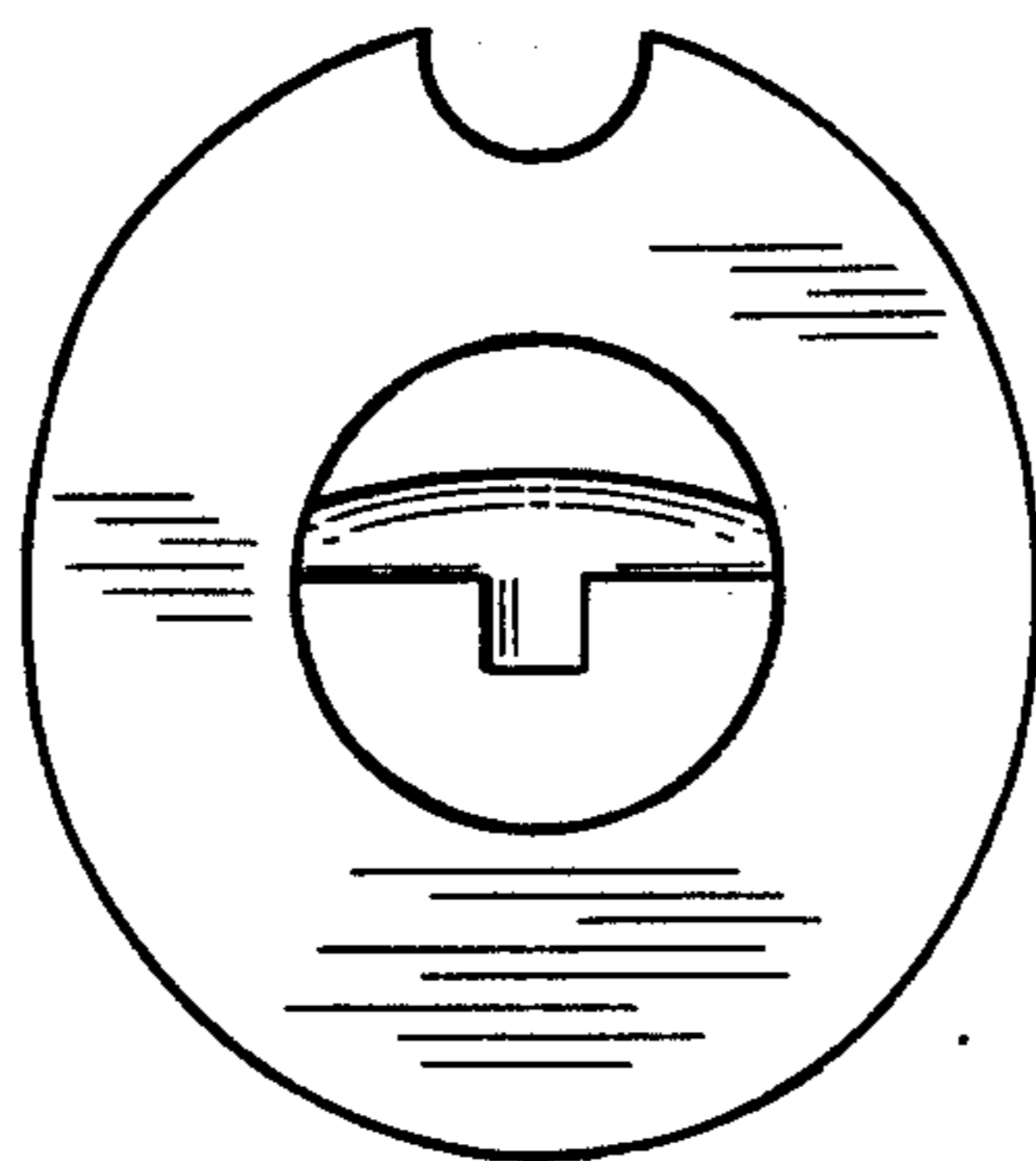

FIG. 4

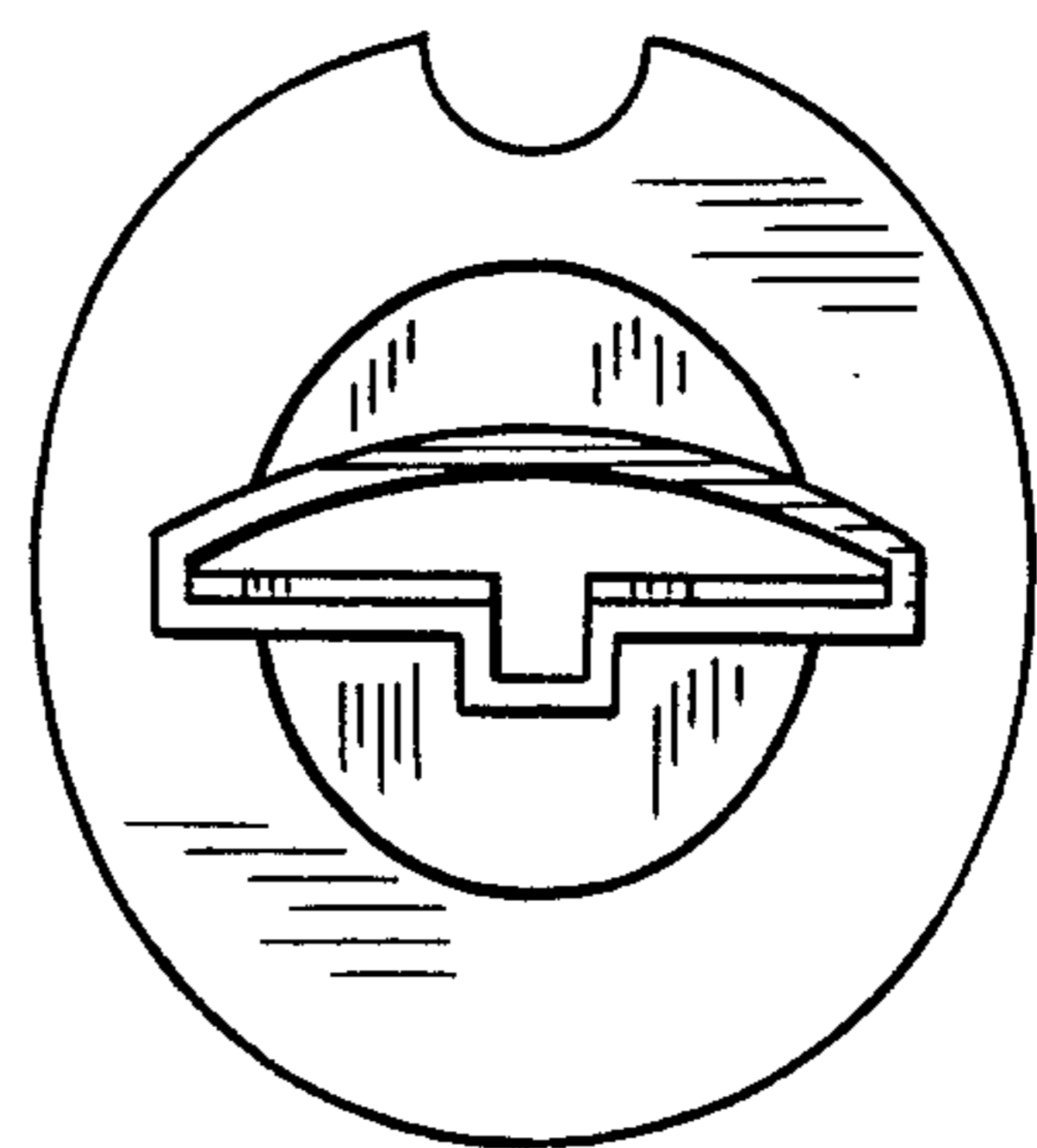

FIG. 7

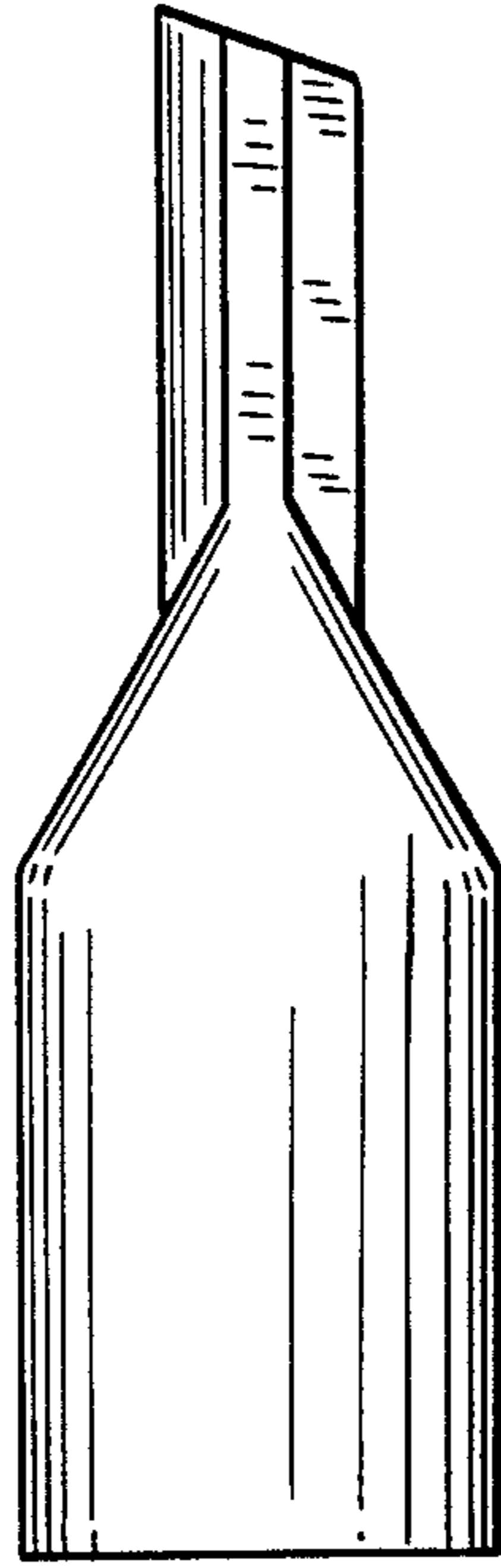

FIG. 8

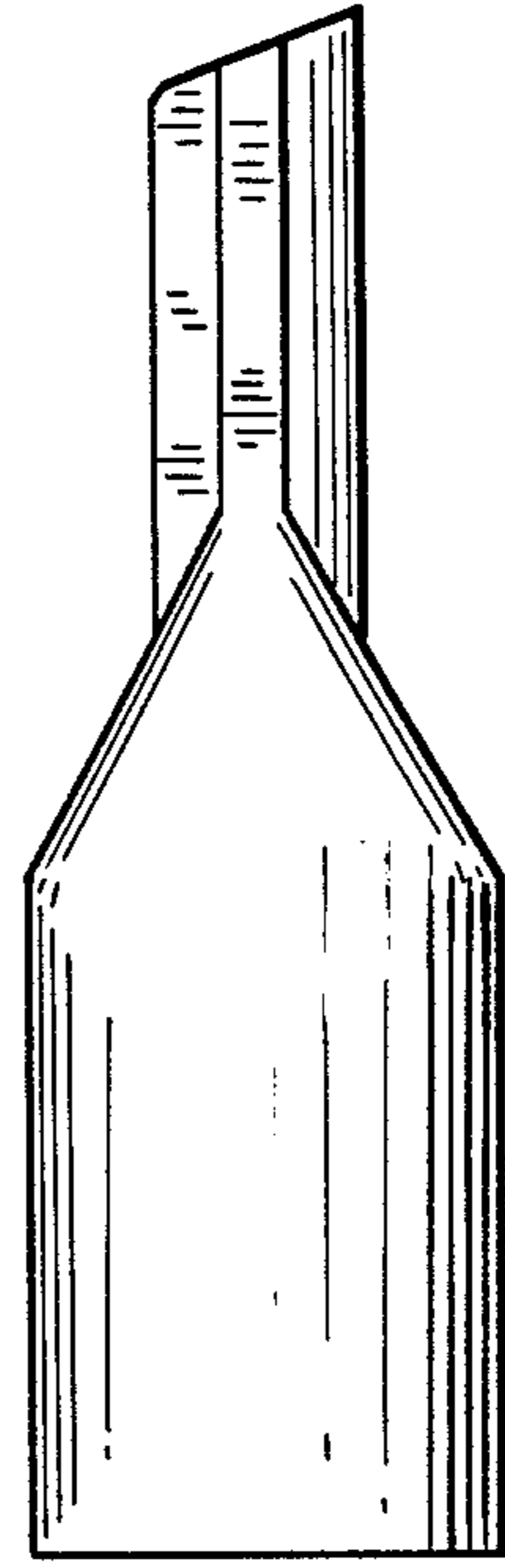

FIG. 5

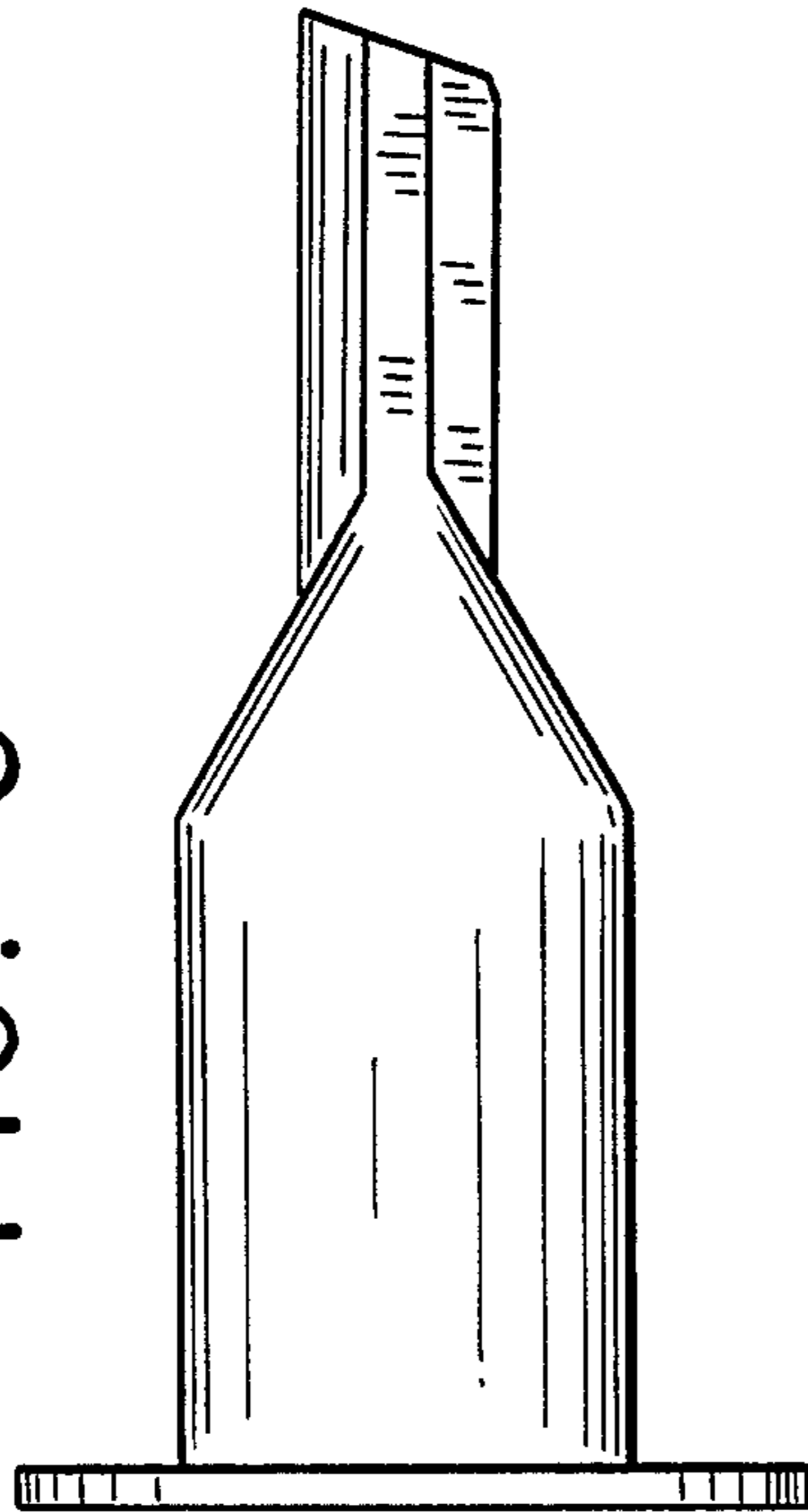

FIG. 6

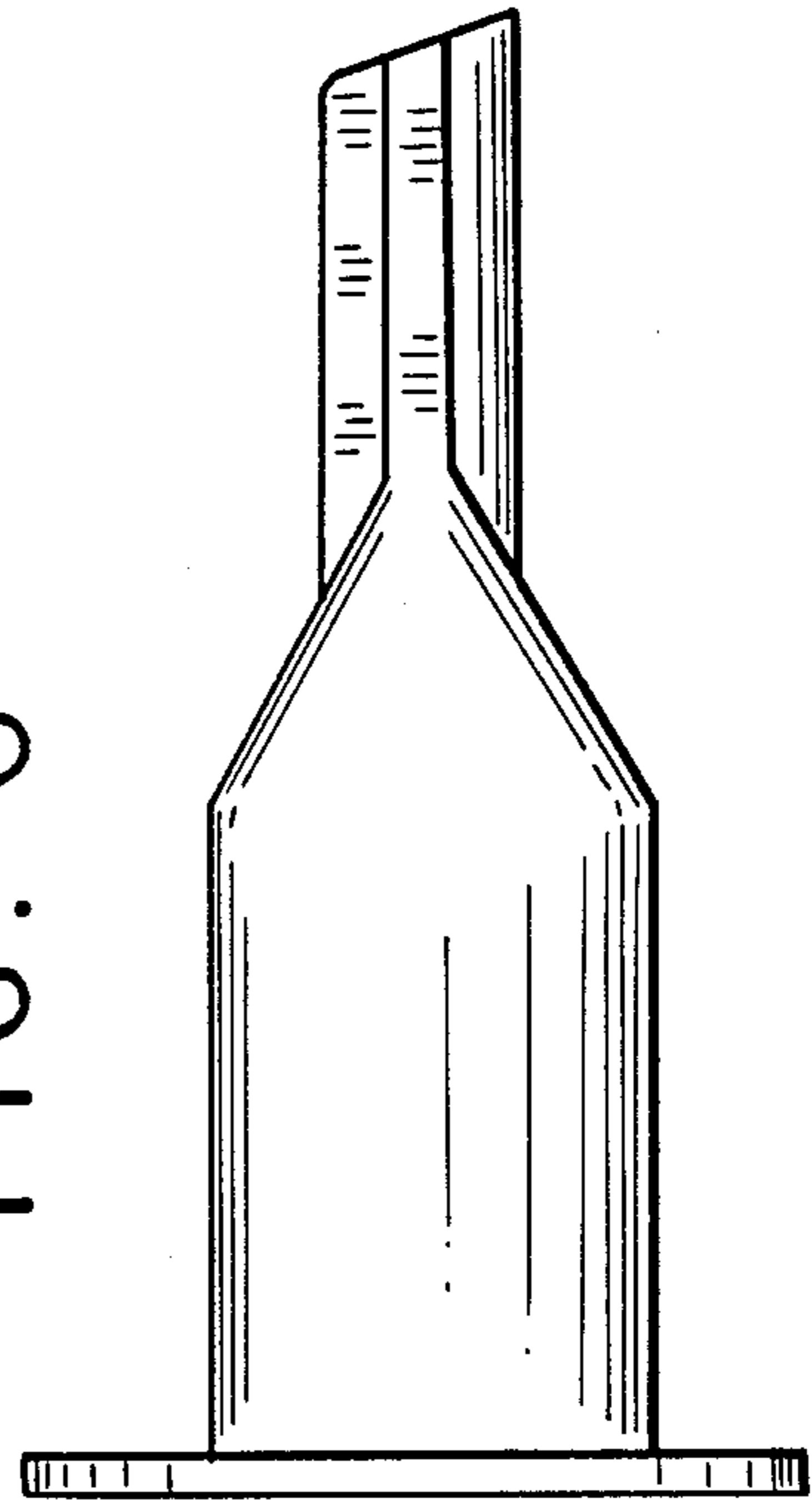

FIG. 9

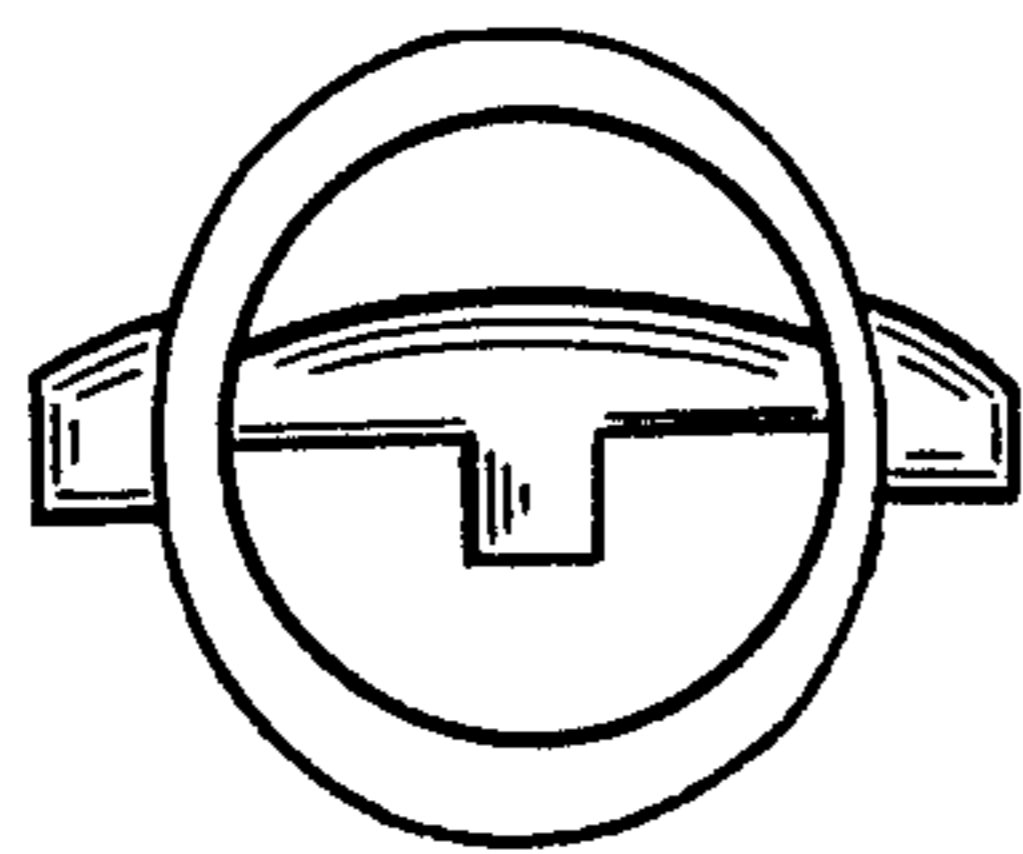

FIG. 10

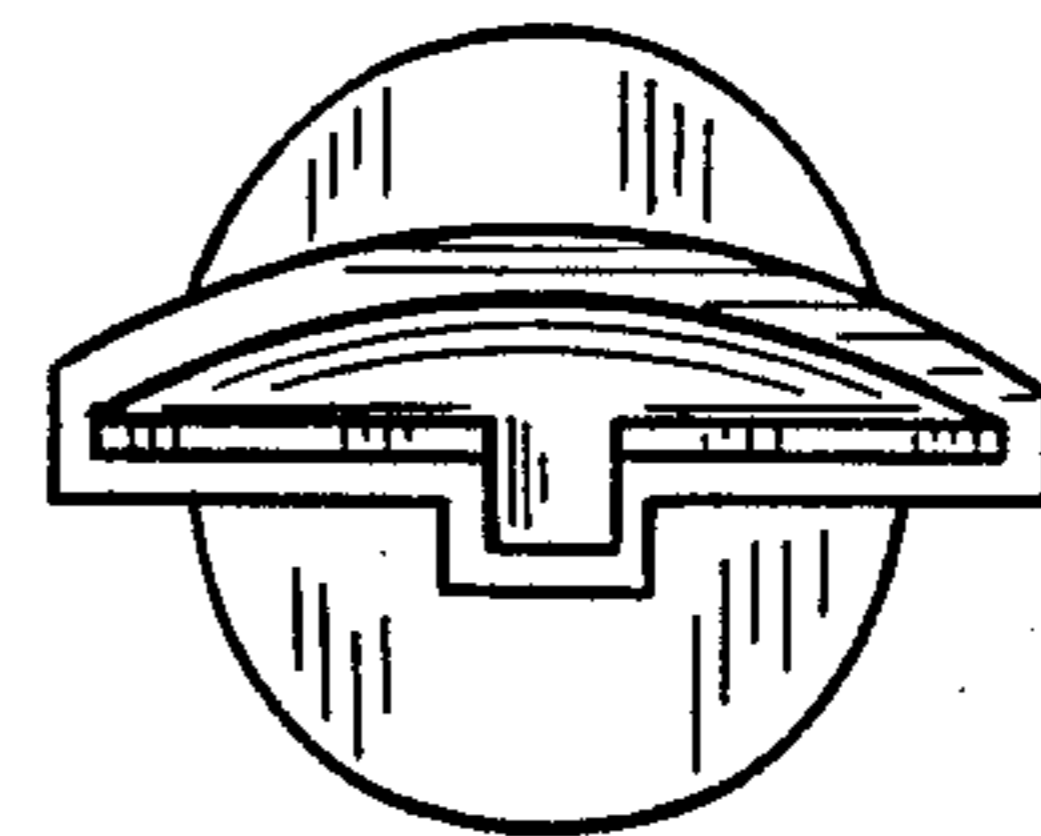

FIG. 11

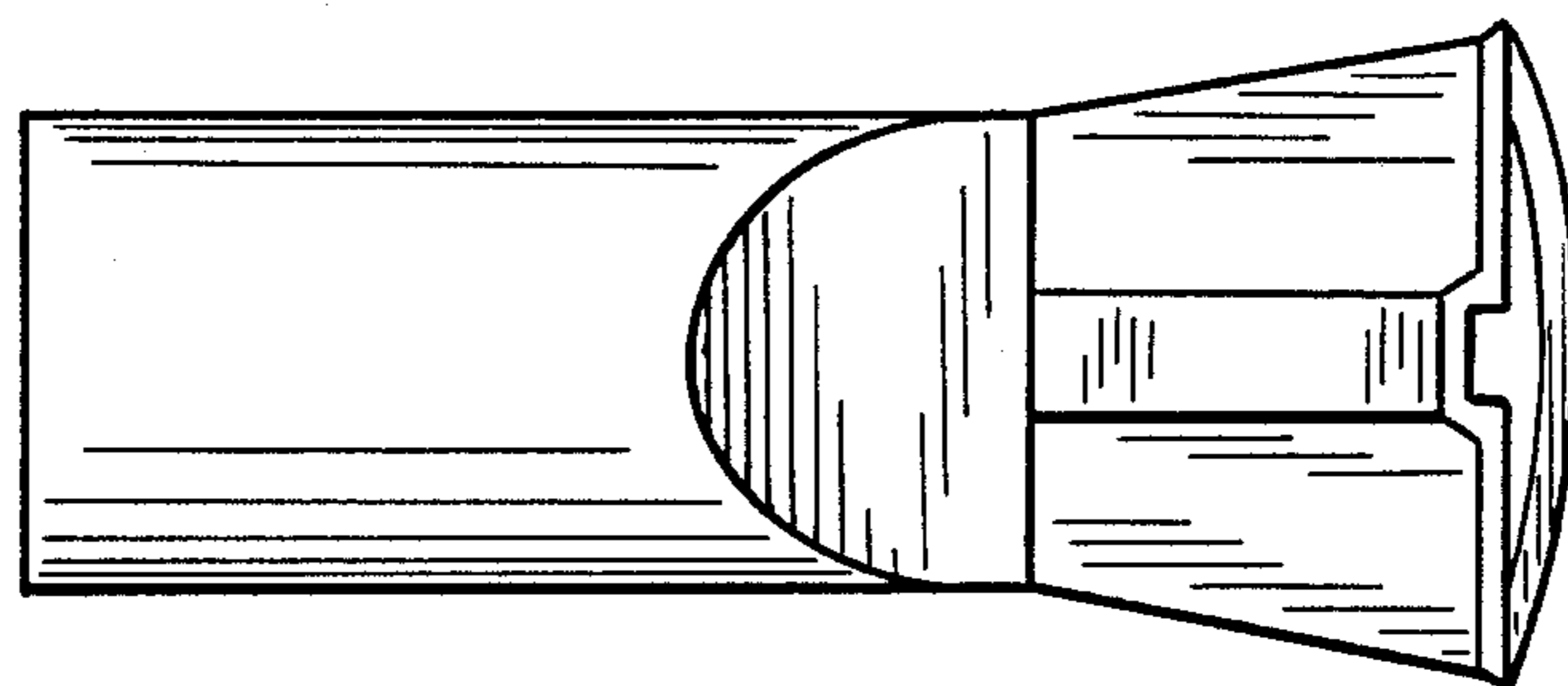

FIG. 12

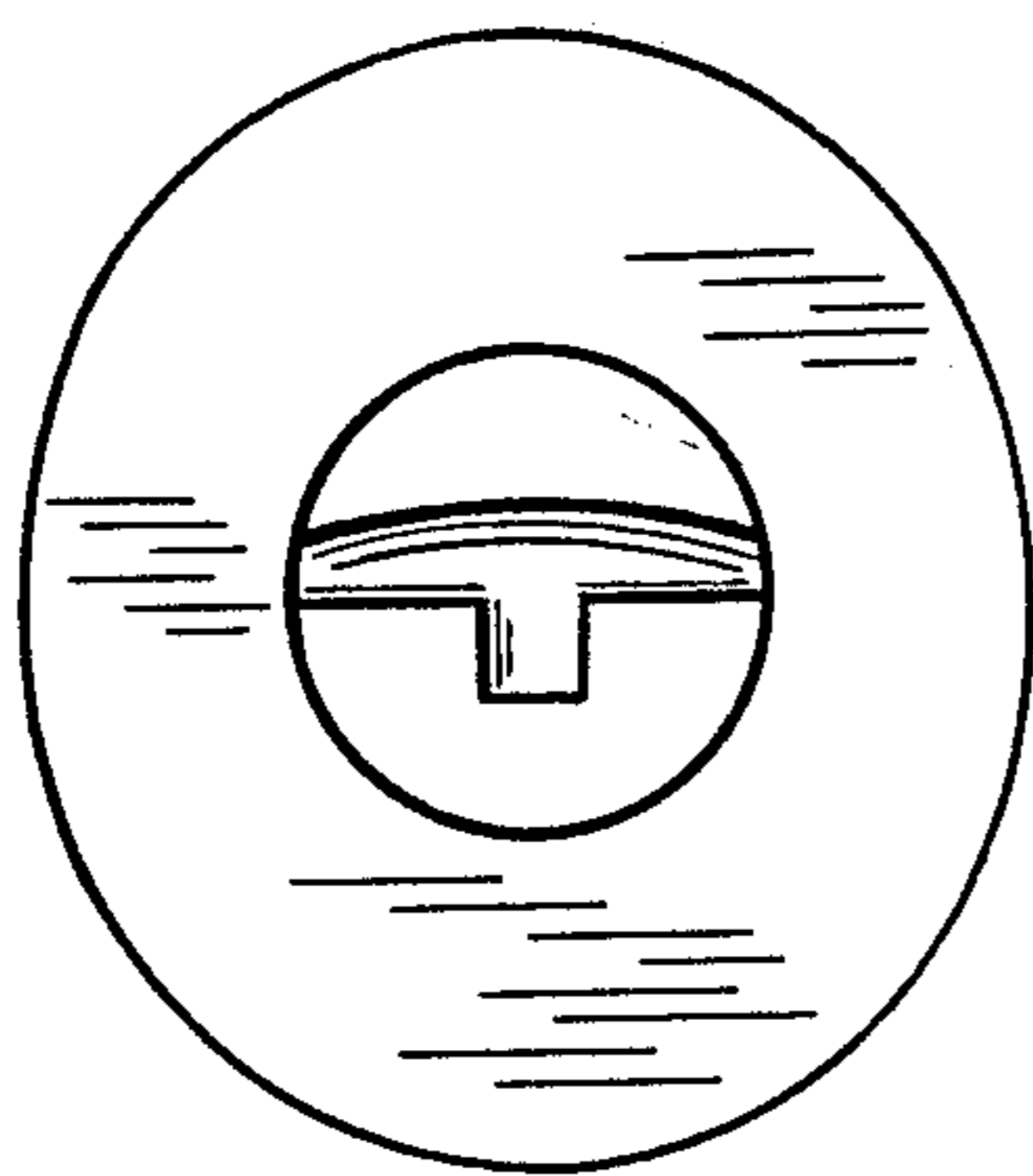
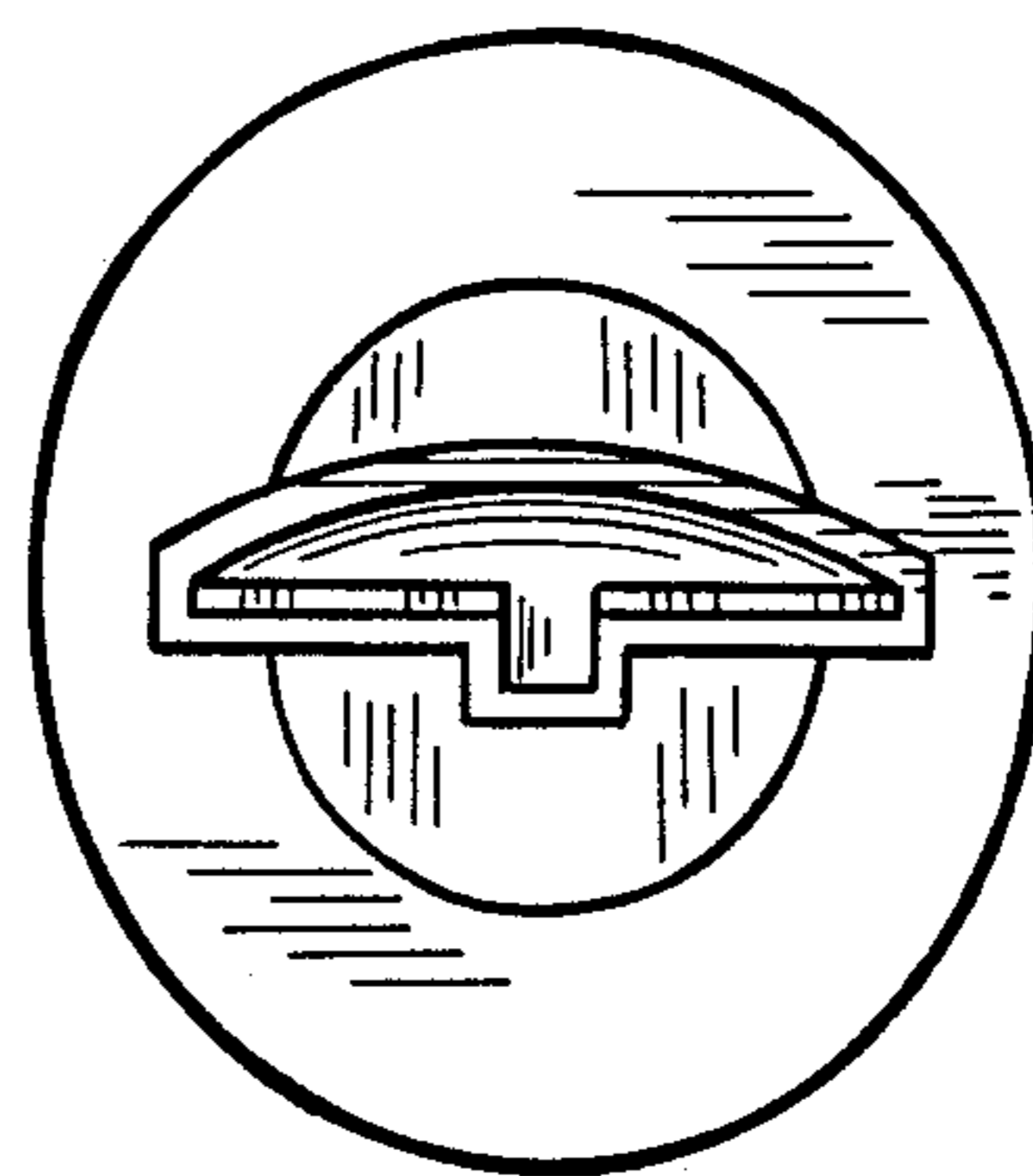

FIG. 13



*FIG. 14*

