

[54] PACKING BAG FOR DISPOSABLE CAMERA

[75] Inventor: Takuya Arai, Tokyo, Japan

[73] Assignee: Fuji Photo Film Co., Ltd., Kanagawa, Japan

[**] Term: 14 Years

[21] Appl. No.: 934,452

[22] Filed: Nov. 24, 1986

[30] Foreign Application Priority Data

May 23, 1986 [JP] Japan 61-19618

[52] U.S. Cl. D9/305

[58] Field of Search D9/305, 306, 307, 415; 220/DIG. 13; 206/461, 471, 463

[56] References Cited

U.S. PATENT DOCUMENTS

D. 121,068	6/1940	Fraterrigo	D9/305
D. 203,231	12/1965	Cohen	D9/307
D. 284,168	6/1986	Ewry	D9/415
4,630,734	12/1986	Severin et al.	206/461

OTHER PUBLICATIONS

Best Products Catalog, Mar. 1973, p. 135, FIG. A Kodak Pocket Instamatic.

Evans Catalog; 1984-1985; p. 343; upper right Kodak Film Carton.

Primary Examiner—B. J. Bullock

Assistant Examiner—Dominic Simone

Attorney, Agent, or Firm—Young & Thompson

[57] CLAIM

The ornamental design for a packing bag for a disposable camera, as shown and described.

DESCRIPTION

FIG. 1 is a front view of a packing bag for a disposable camera, showing my new design;

FIG. 2 is a rear view thereof;

FIG. 3 is a right side view thereof;

FIG. 4 is a left side view thereof;

FIG. 5 is a top plan view thereof;

FIG. 6 is a bottom plan view thereof;

FIG. 7 is a perspective view thereof;

FIG. 8 is a front perspective view thereof, the camera shown in broken lines for illustrative purposes only.

The stippling in the drawings indicates a darker color than the areas that are not stippled.

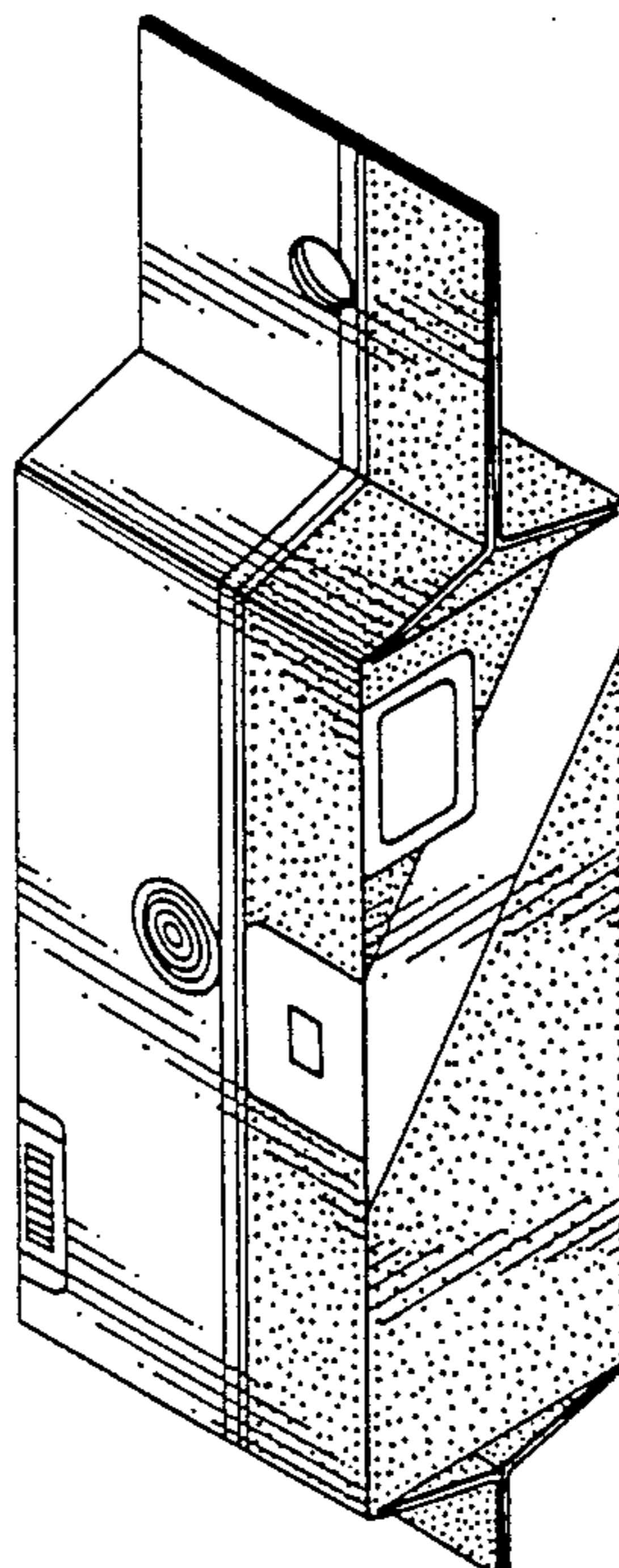

FIG. 1

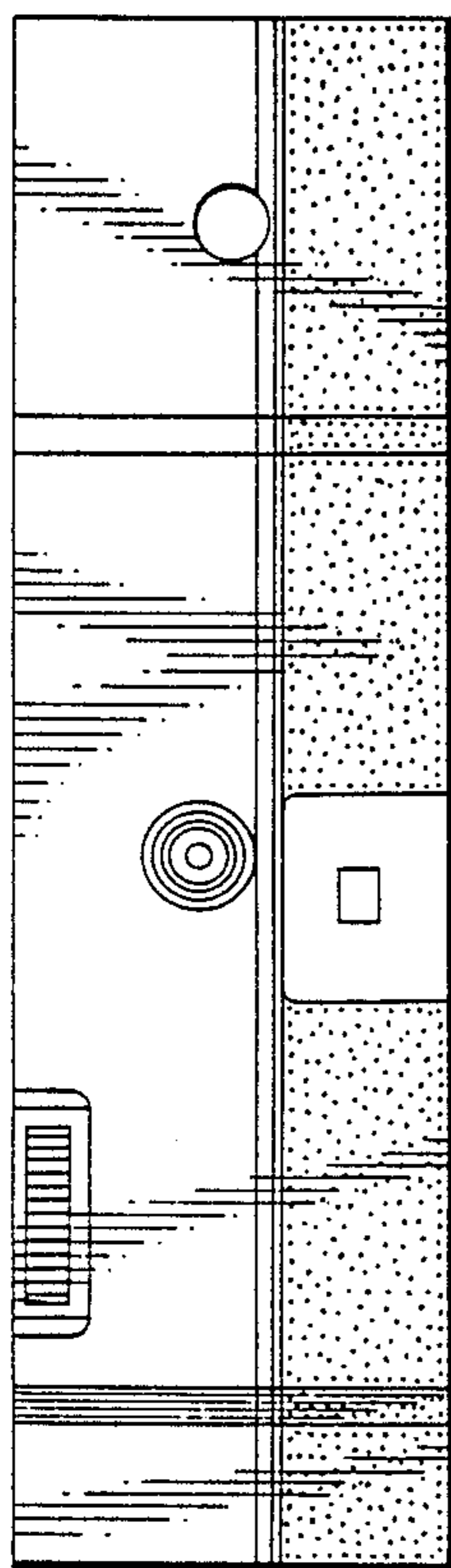

FIG. 2

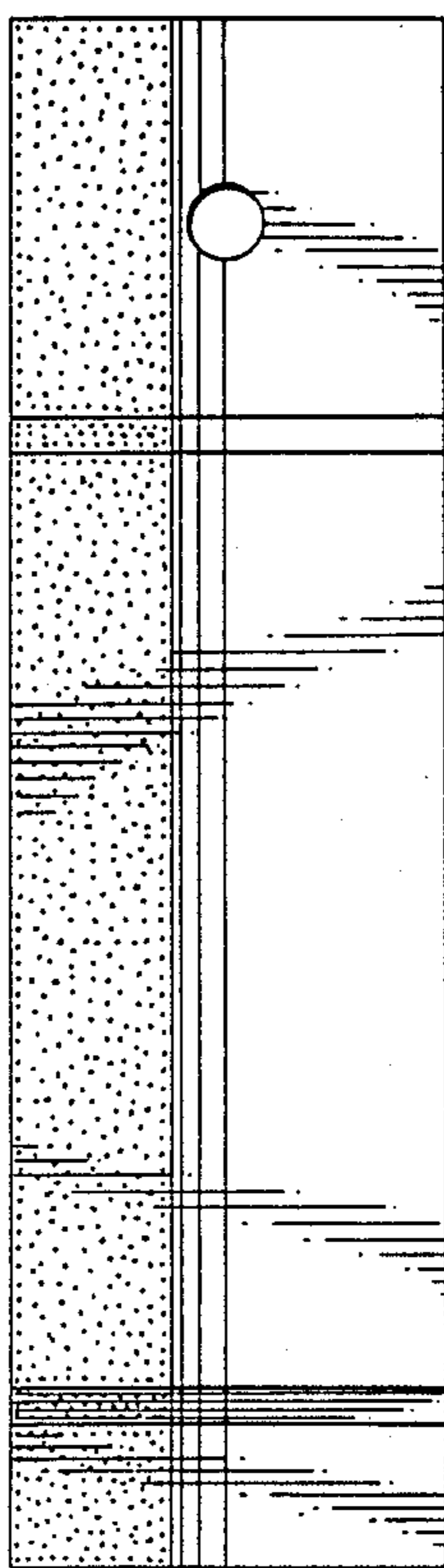

FIG. 3

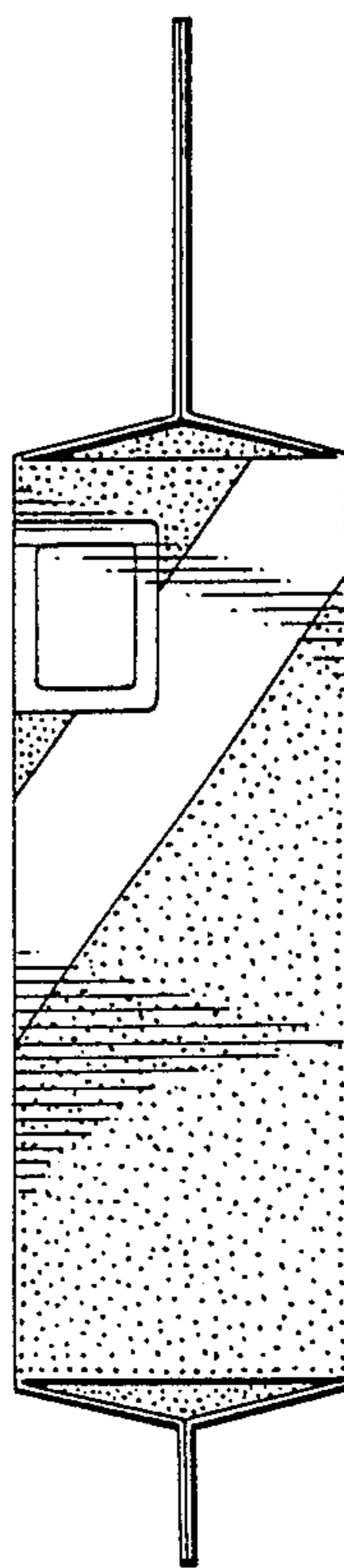

FIG. 4

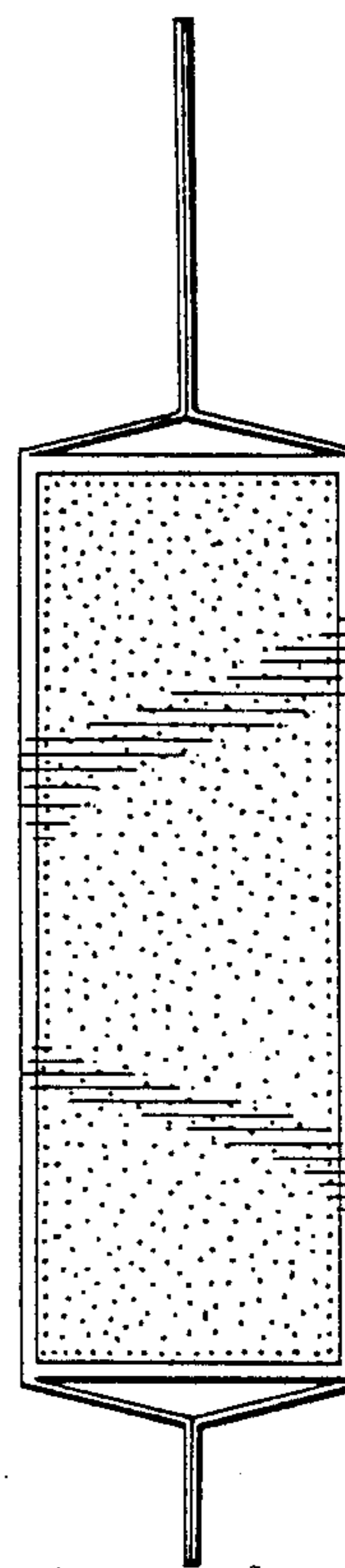

FIG. 5

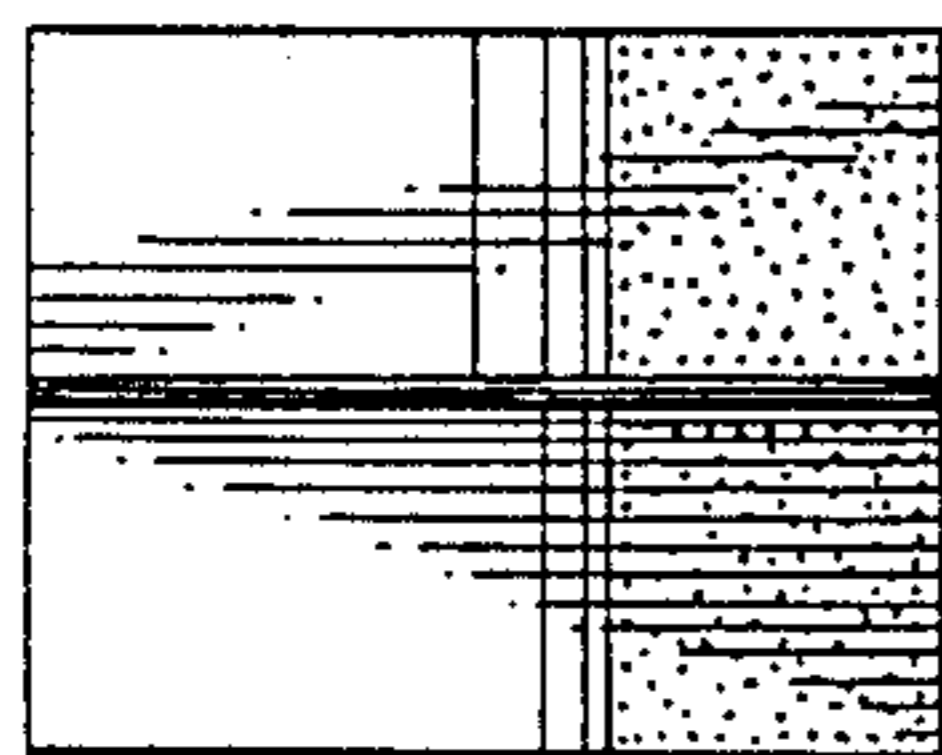

FIG. 6

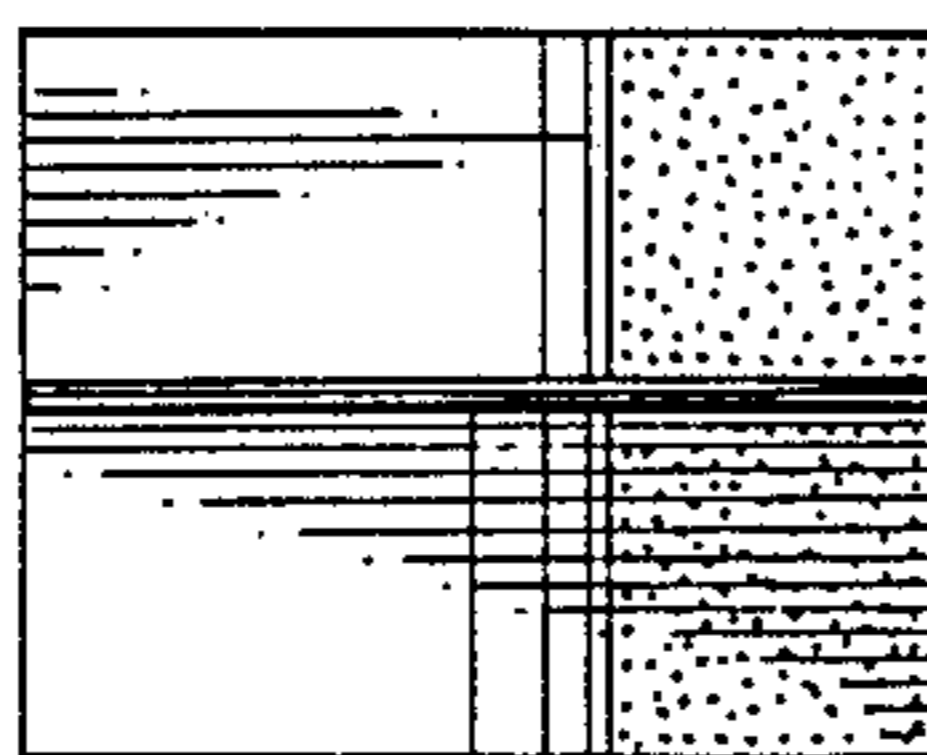

FIG. 7

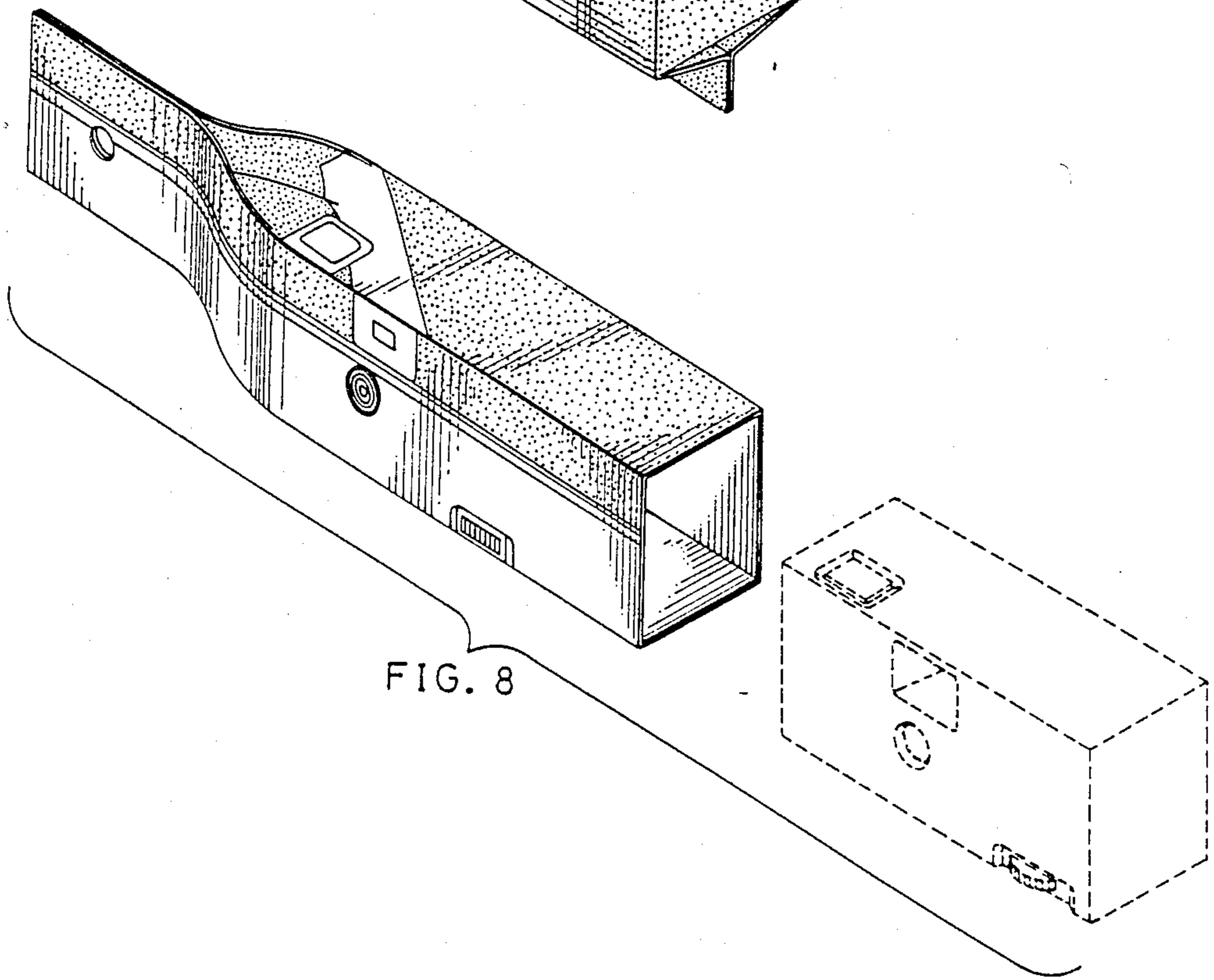
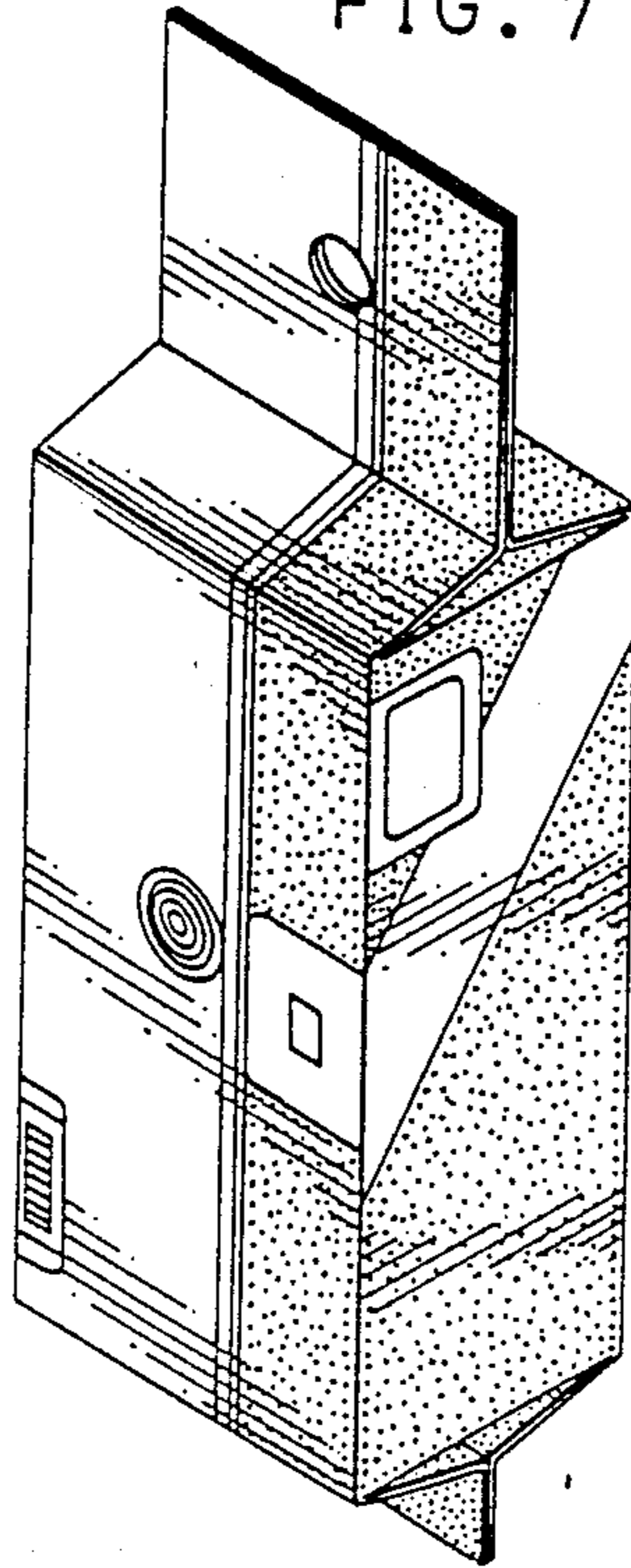

FIG. 8