

[54] CONFECTIONARY

[76] Inventor: Charles K. Sawyer, 26940 Lime City Rd., Perrysburg, Ohio 43551

[\*\*] Term: 14 Years

[21] Appl. No.: 69,932

[22] Filed: Jul. 6, 1987

[52] U.S. Cl. .... D1/108; D1/127

[58] Field of Search ..... 128/859; 206/83; 74/457; D1/126, 108, 127, 109, 106; D11/102; 426/514, 808, 143, 5, 439, 660; D24/49, 45, 16; D29/6, 10, 99, 16

[56] References Cited

U.S. PATENT DOCUMENTS

D. 220,375	4/1971	Dogliotti	.....	D1/127
626,287	6/1899	Modemann	.....	206/83 X
1,239,167	9/1917	Dickson	.....	D1/127 X

1,654,387	12/1927	Stenz	.....	206/83 X
1,938,222	12/1933	Green	.....	206/83 X
4,071,026	1/1978	Bevins	.....	128/859 X

Primary Examiner—Wallace R. Burke  
Assistant Examiner—Pamela J. Schmidt  
Attorney, Agent, or Firm—Marshall & Melhorn

[57] CLAIM

The ornamental design for a confectionary, as shown and described.

DESCRIPTION

FIG. 1 is a front elevational view of a confectionary showing my new design;  
FIG. 2 is a right side elevational view thereof;  
FIG. 3 is a top plan view thereof;  
FIG. 4 is a bottom plan view thereof;  
FIG. 5 is a rear elevational view thereof; and  
FIG. 6 is a sectional view taken along line 6—6 of FIG. 1 thereof.

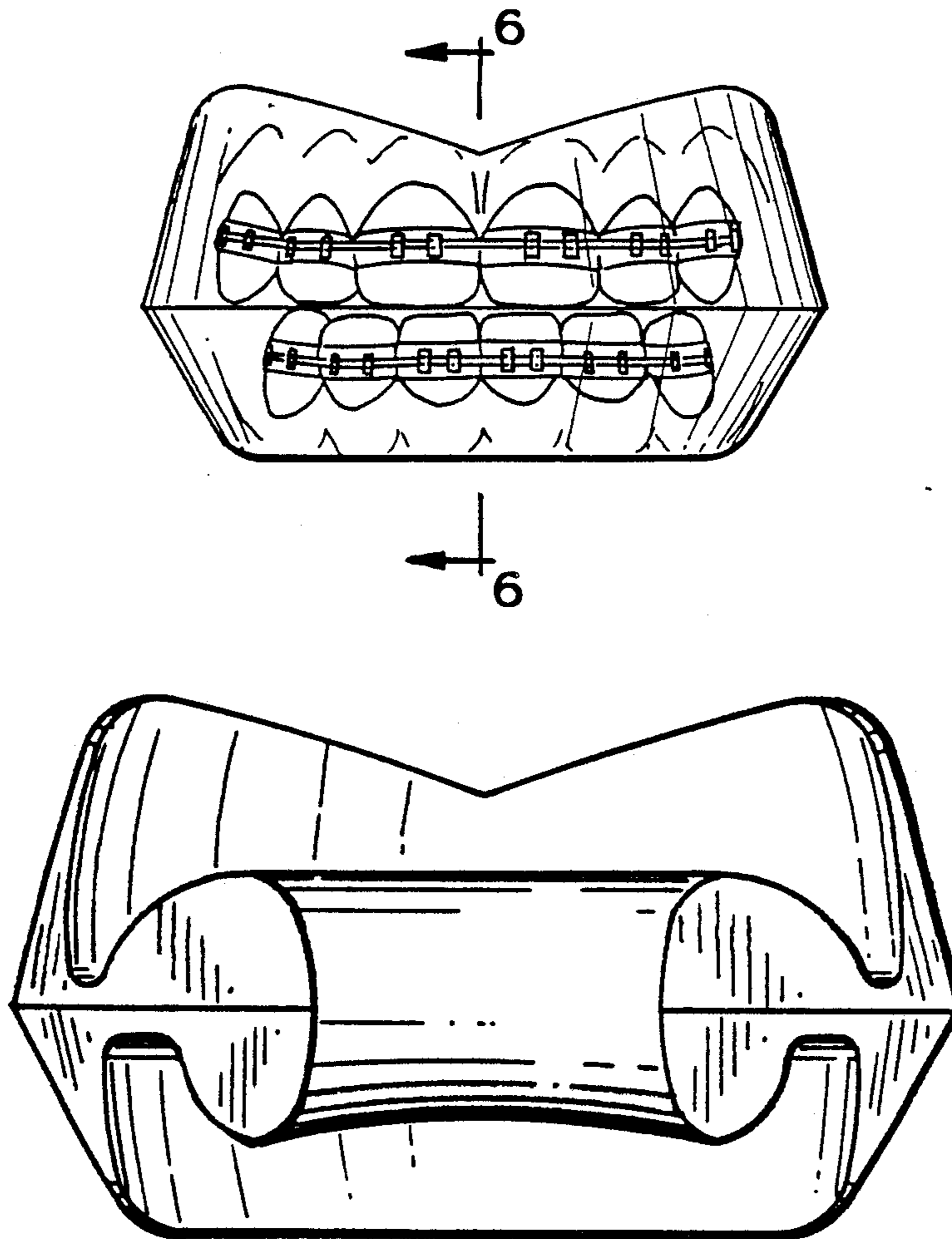

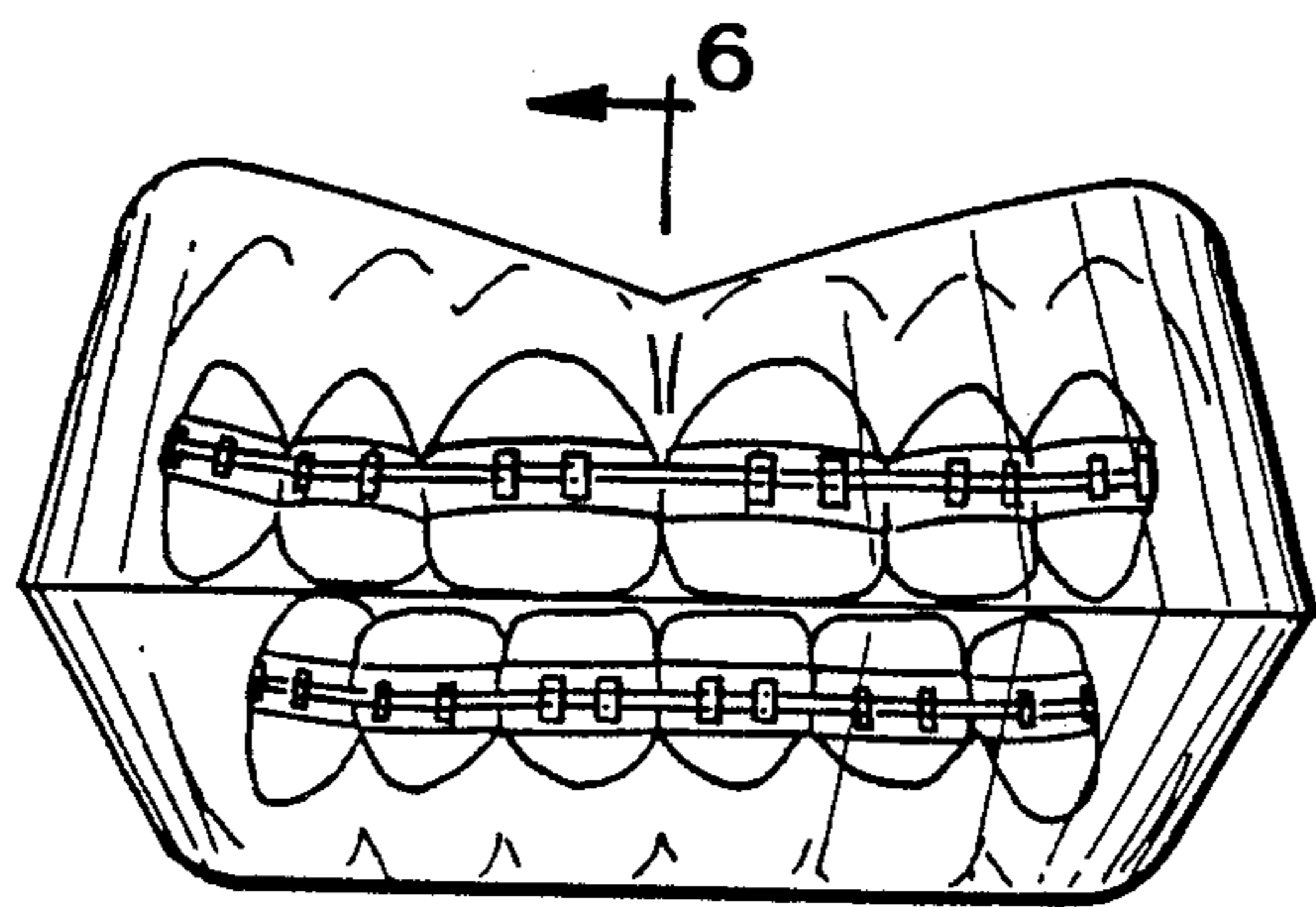

FIG. 1

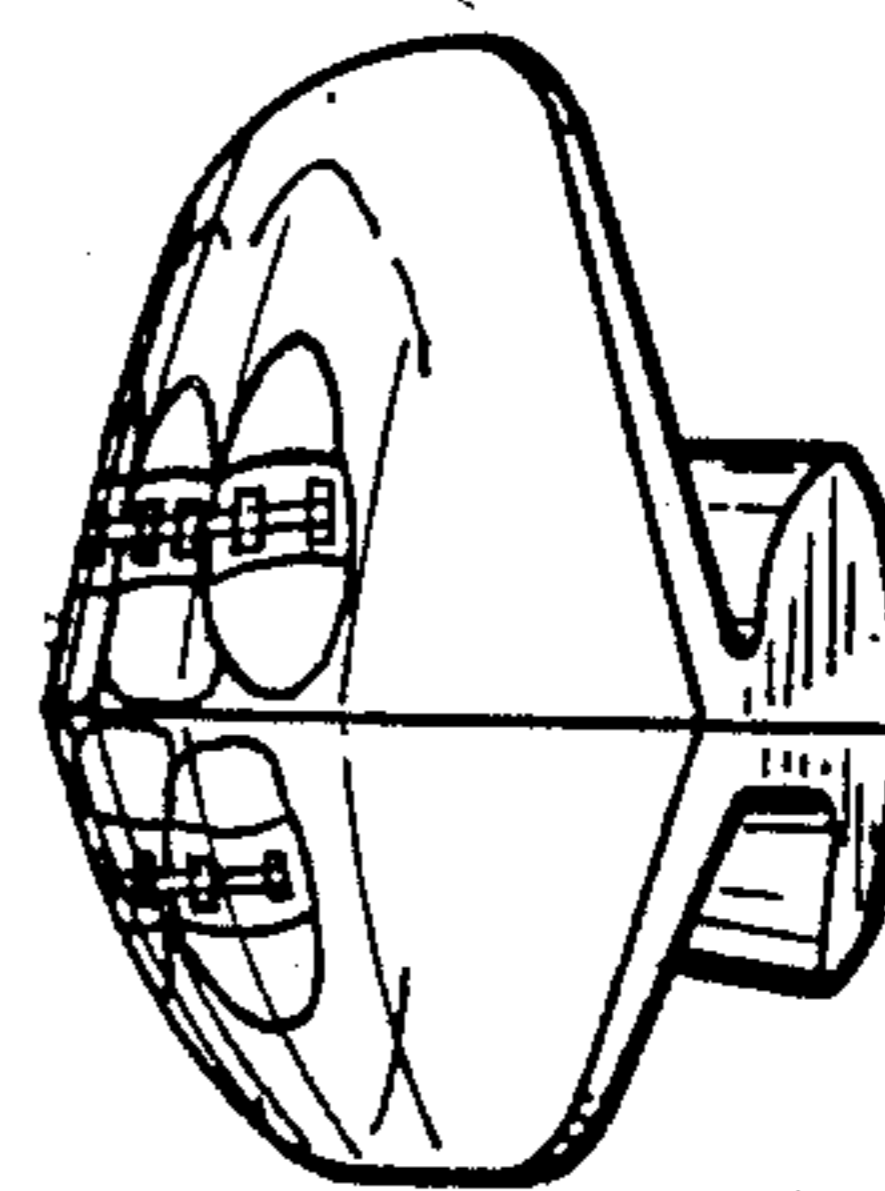

FIG. 2

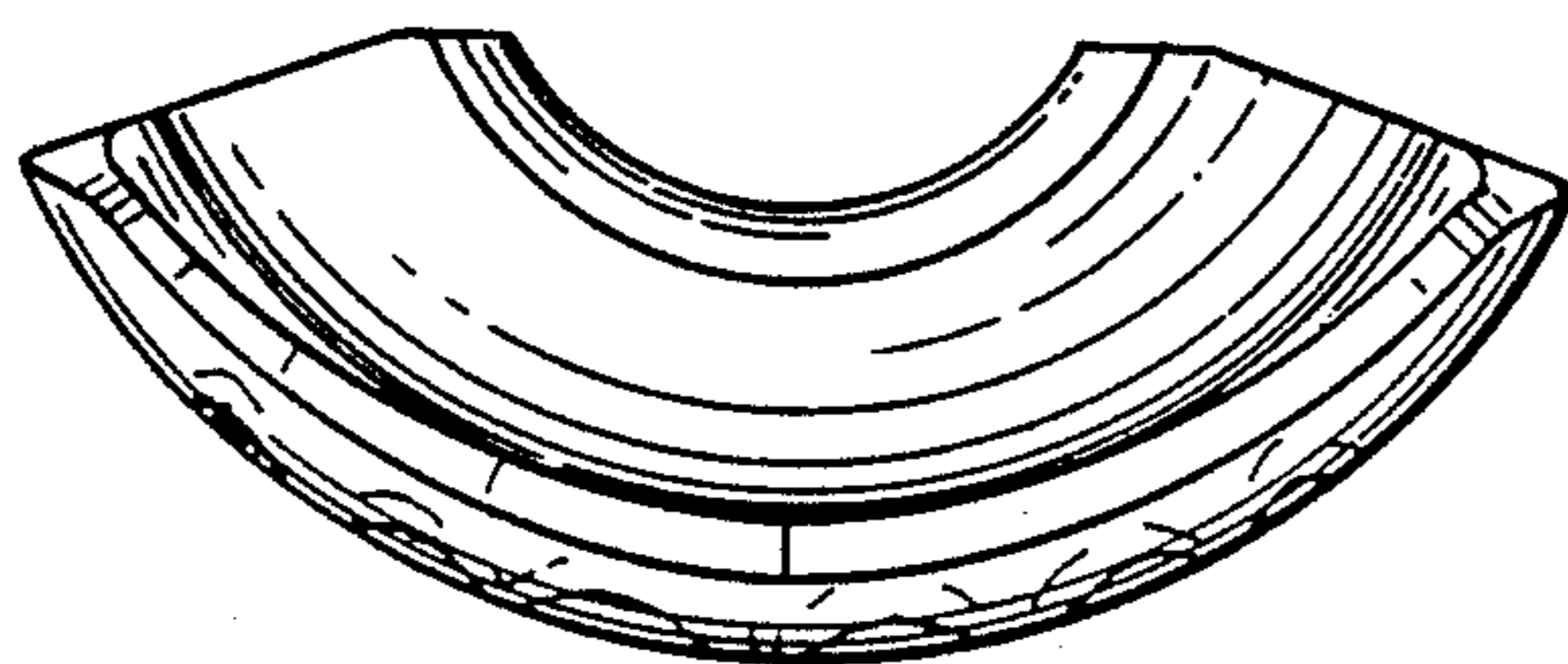

FIG. 3

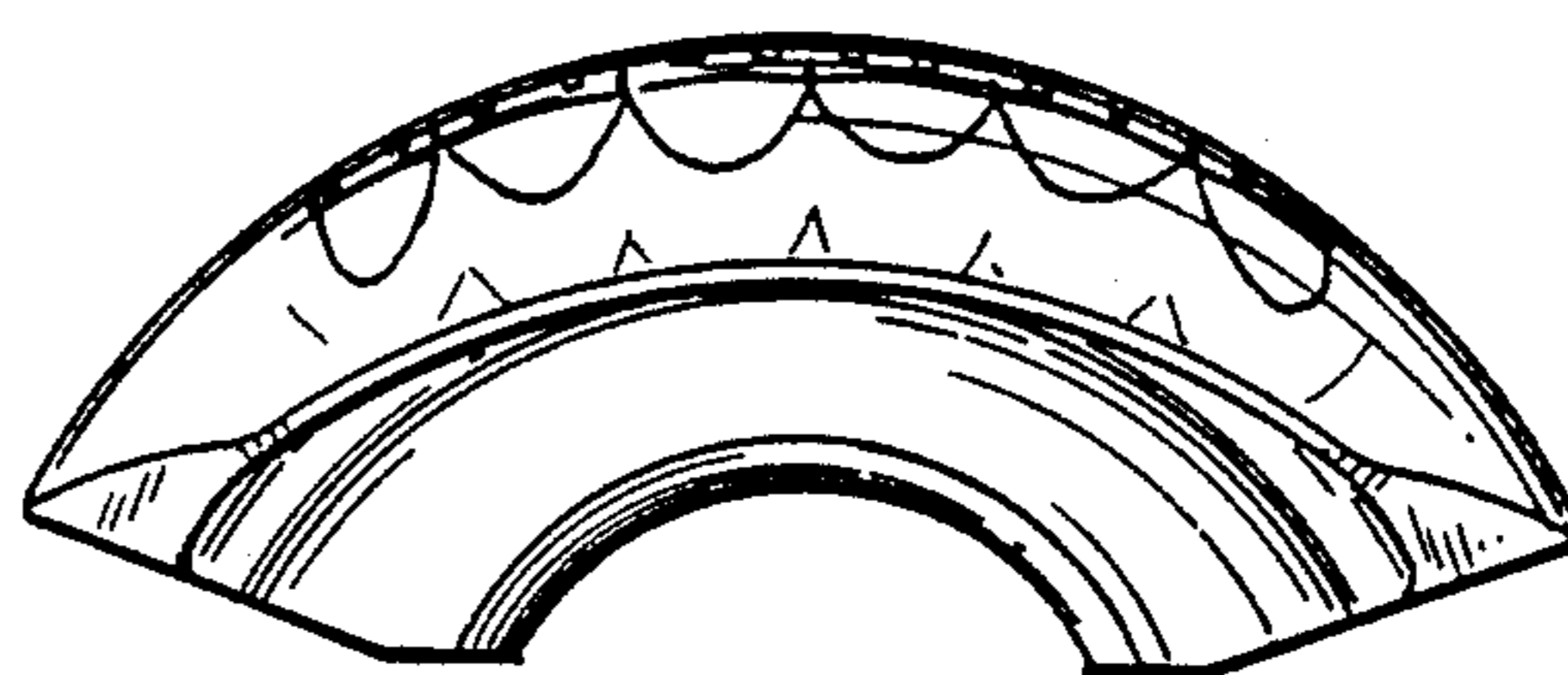

FIG. 4

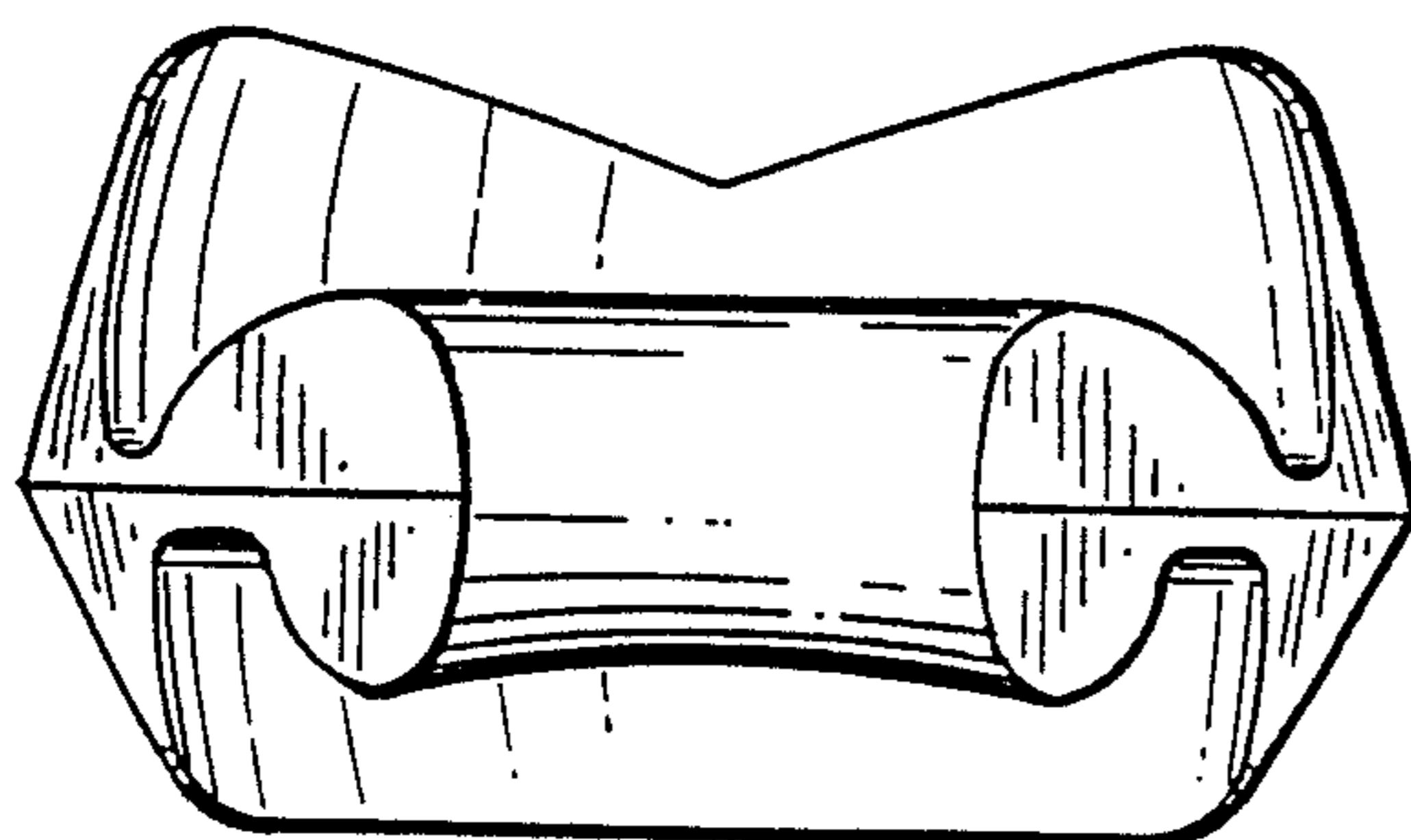

FIG. 5

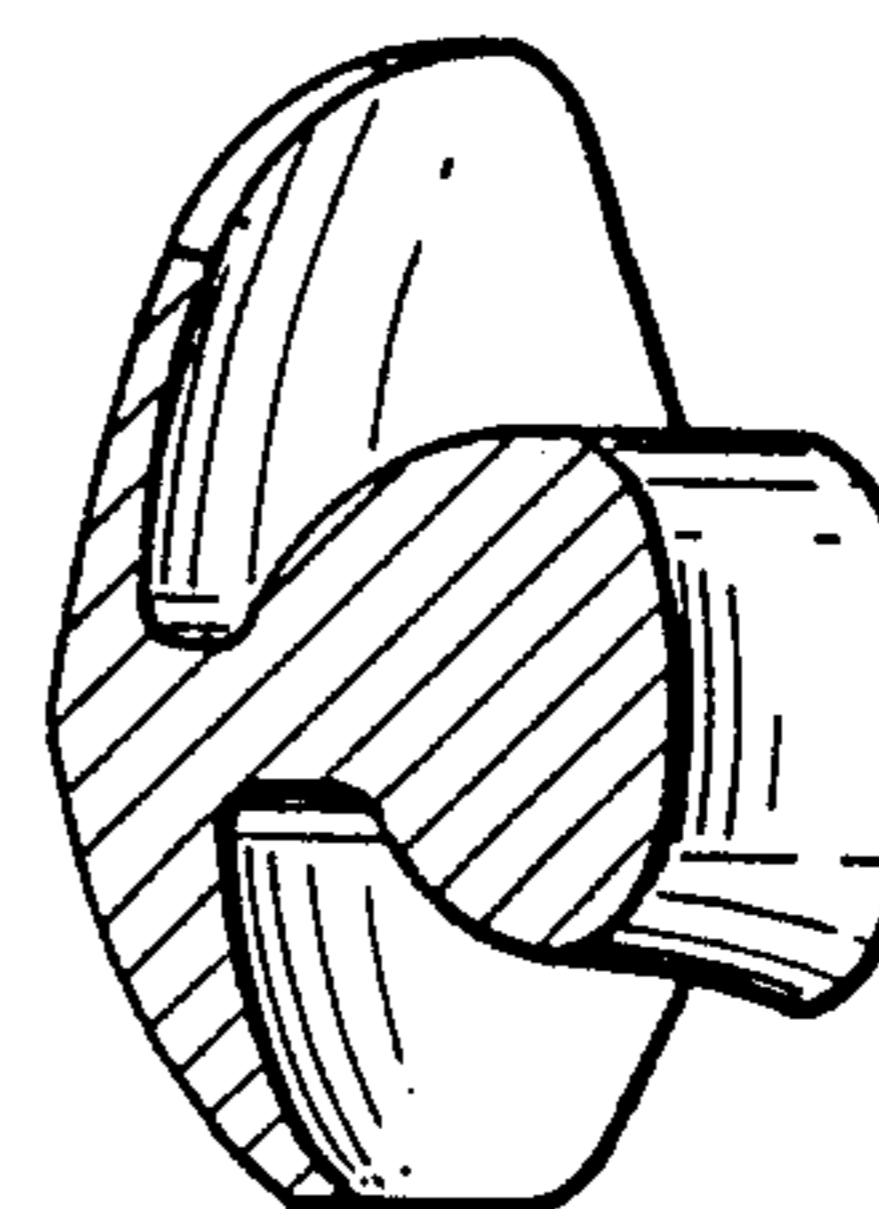

FIG. 6