

[54] ILLUMINATED MAP HOLDER

[76] Inventors: Theresa M. Narbut, 269 W. Camino Real, Arcadia, Calif. 91006; Andres E. Ramirez, 551 Meadow Grove, Flintridge, Calif. 91011

[**] Term: 14 Years

[21] Appl. No.: 144,079

[22] Filed: Jan. 15, 1988

[52] U.S. Cl. D26/58; D26/51; D19/62; D19/52; D19/92

[58] Field of Search D26/37-50, D26/51, 58, 104, 105; 362/97, 157-158, 183-208, 98, 99; 40/904

[56] References Cited

U.S. PATENT DOCUMENTS

D. 199,457	10/1964	Abright	D26/104
729,736	6/1903	Collamore .	
1,730,790	10/1929	Squires .	
2,501,840	3/1950	Bradford .	
2,563,580	8/1951	Clark .	
2,629,043	2/1953	Holtje .	
2,658,989	11/1953	Marschat	362/99 X
3,356,839	12/1967	Mehess et al.	362/97 X
3,553,864	1/1968	Karlyn et al.	40/904 X
4,157,626	6/1979	Bedinghaus	40/904 X

Primary Examiner—Susan J. Lucas
Assistant Examiner—M. H. Tung
Attorney, Agent, or Firm—Milton Gerstein

[57] CLAIM

The ornamental design for the illuminated map holder, as shown and described.

DESCRIPTION

FIG. 1 is a top, side isometric view of an illuminated map holder showing my new design; FIG. 2 is a right side elevational view thereof; FIG. 3 is a top plan view thereof; FIG. 4 is a bottom plan view thereof; FIG. 5 is a left side elevational view thereof; FIG. 6 is a front elevational view thereof; FIG. 7 is a rear elevational view thereof; FIG. 8 is a top side isometric view of a second embodiment thereof, the second differs from the first because of the slightly modified body shape; FIG. 9 is a right side elevational view thereof; FIG. 10 is a top plan view thereof; FIG. 11 is a bottom plan view thereof; FIG. 12 is a left side elevational view thereof; FIG. 13 is a front elevational view thereof; FIG. 14 is a rear elevational view thereof; FIG. 15 is a top side isometric view of a third embodiment thereof, the third differs from the original because of the pair of retaining clips and a body shape similar to the second embodiment.

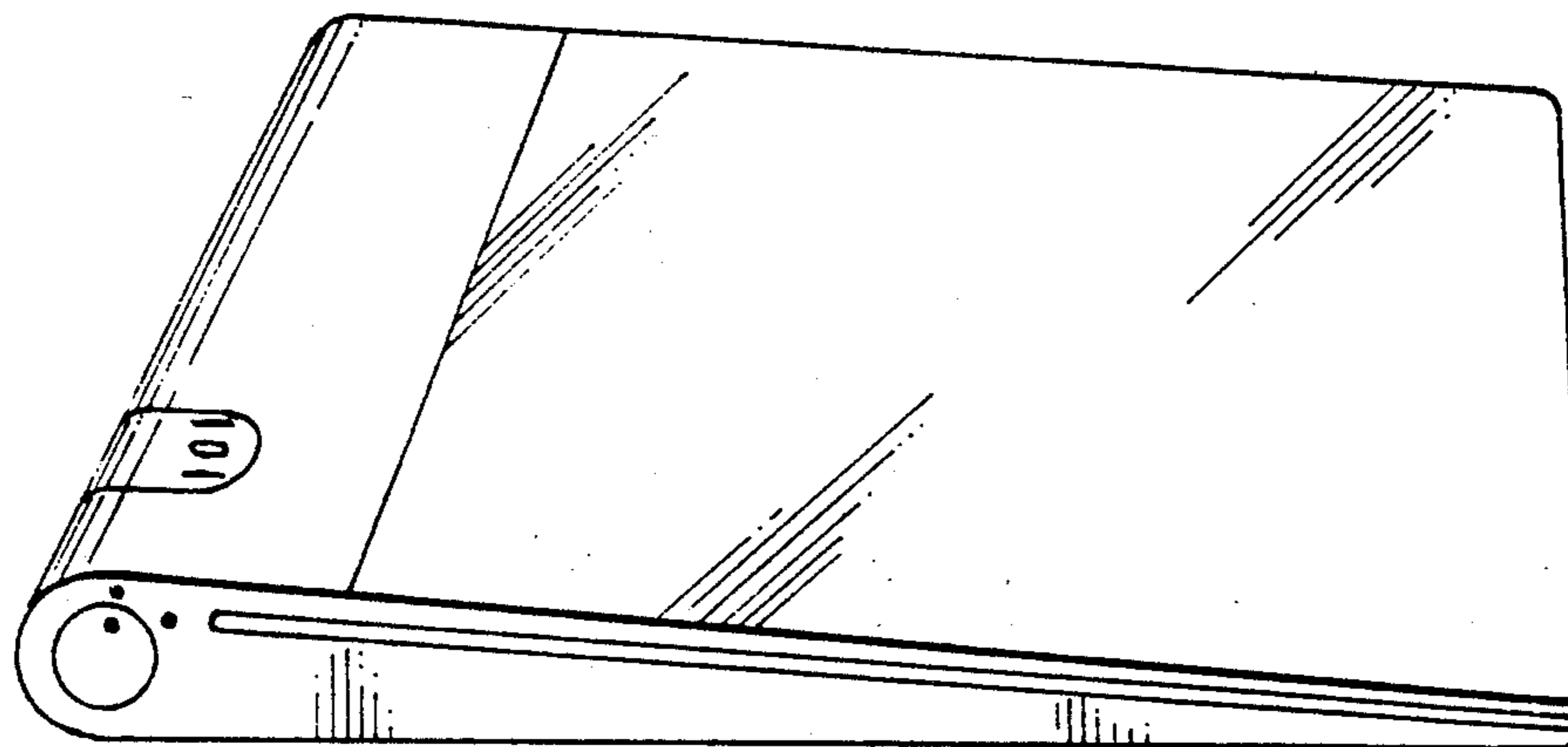

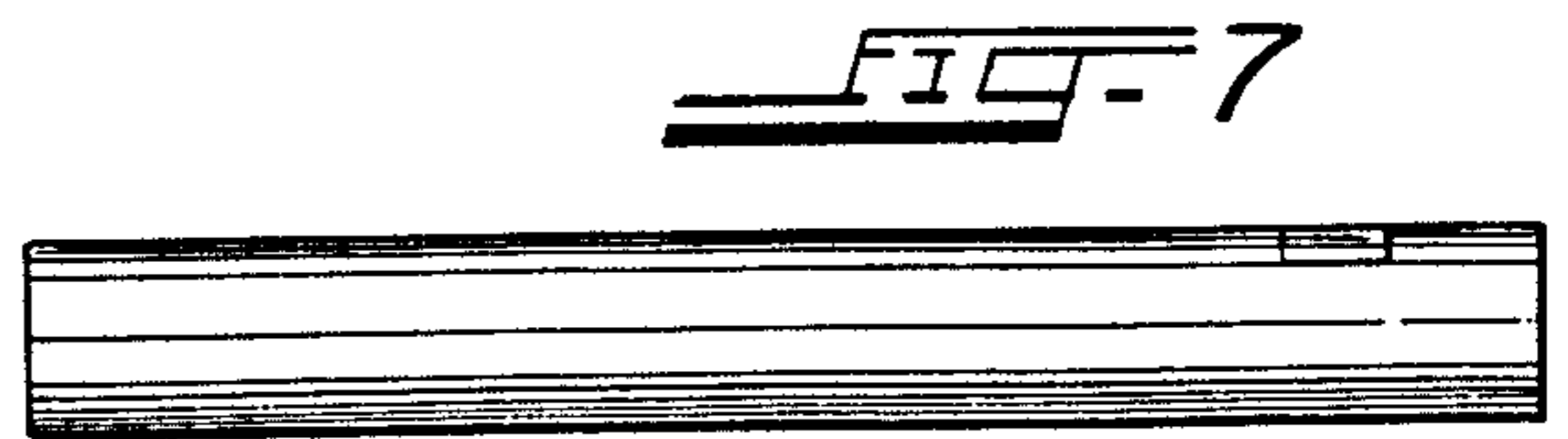
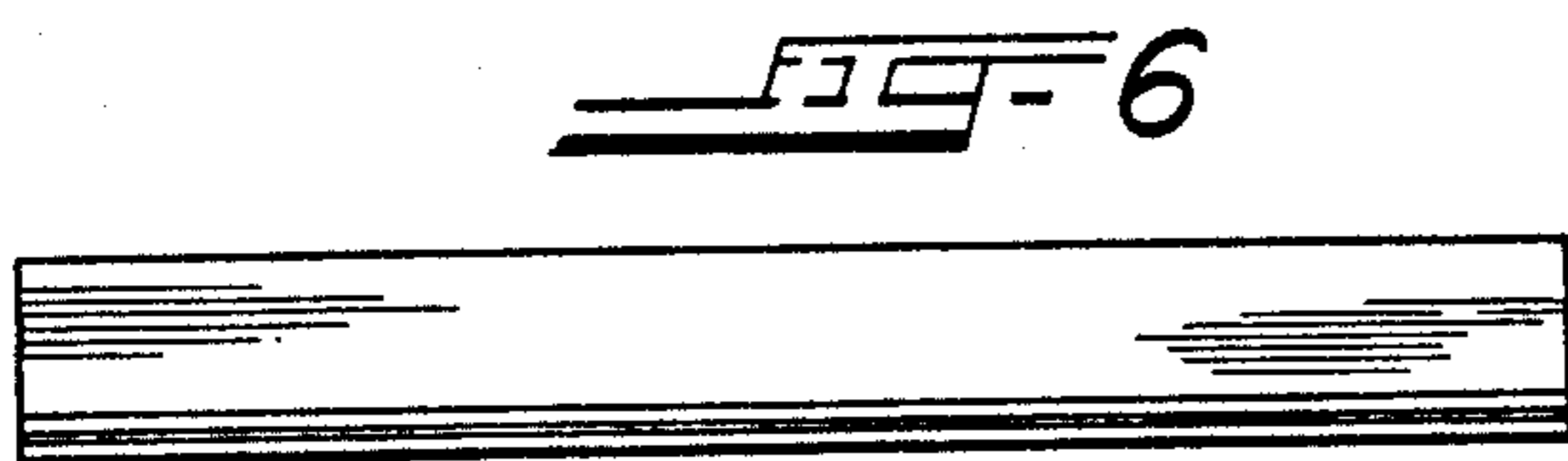
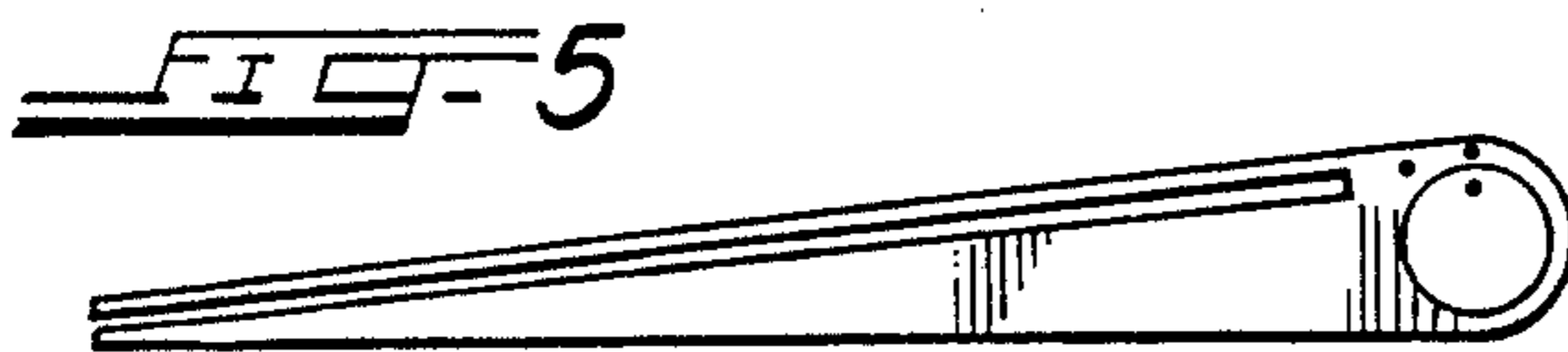
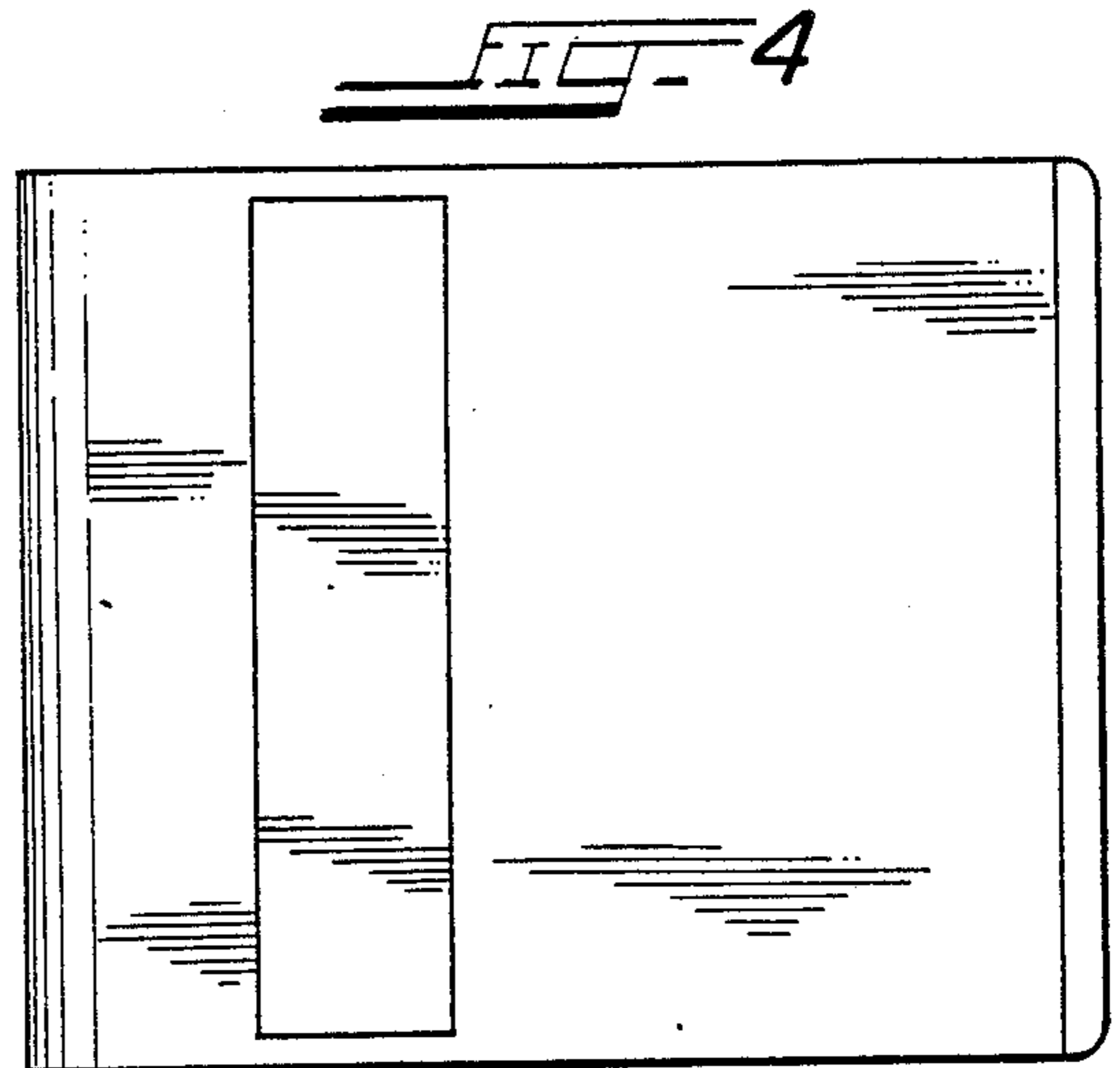
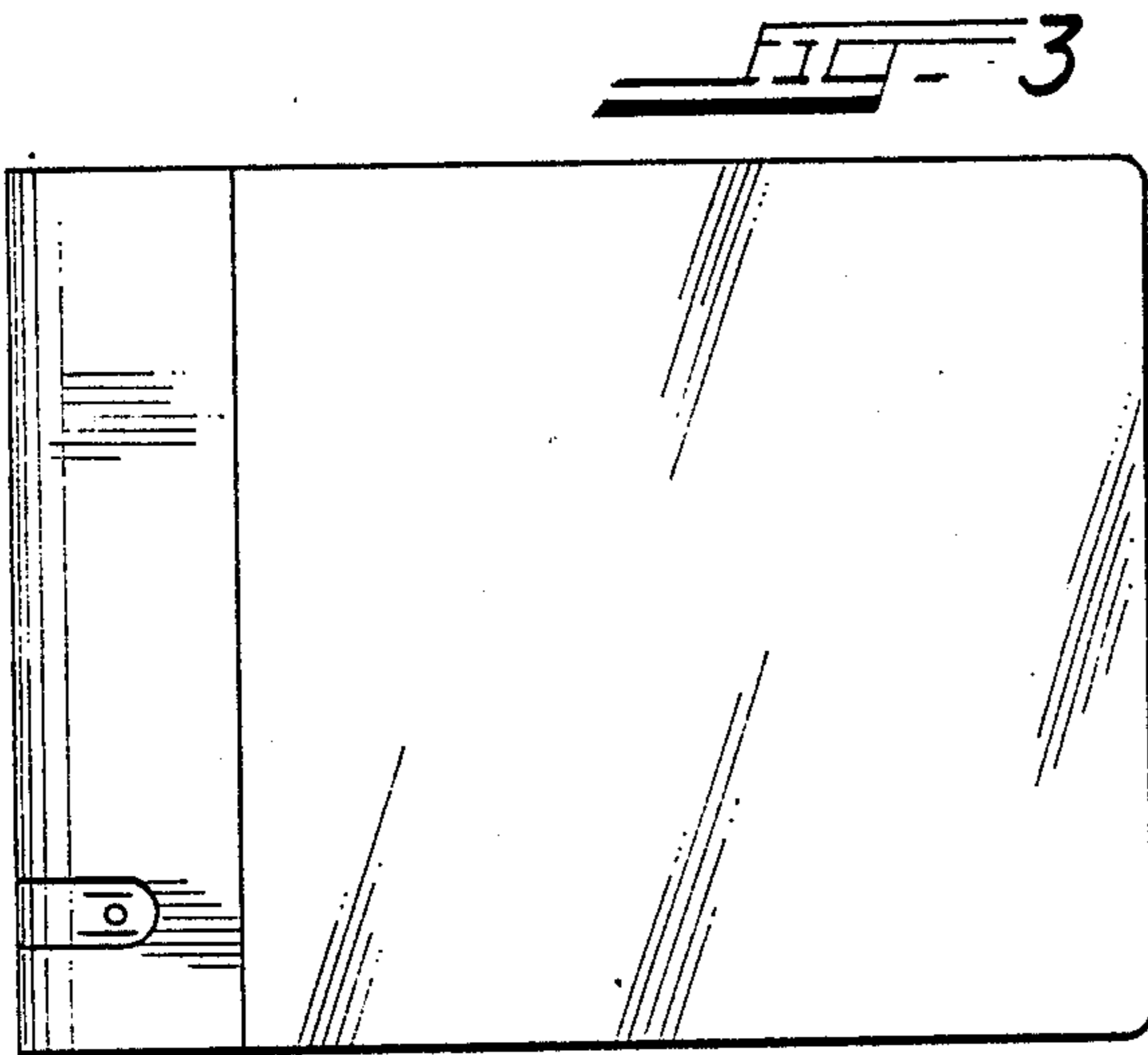
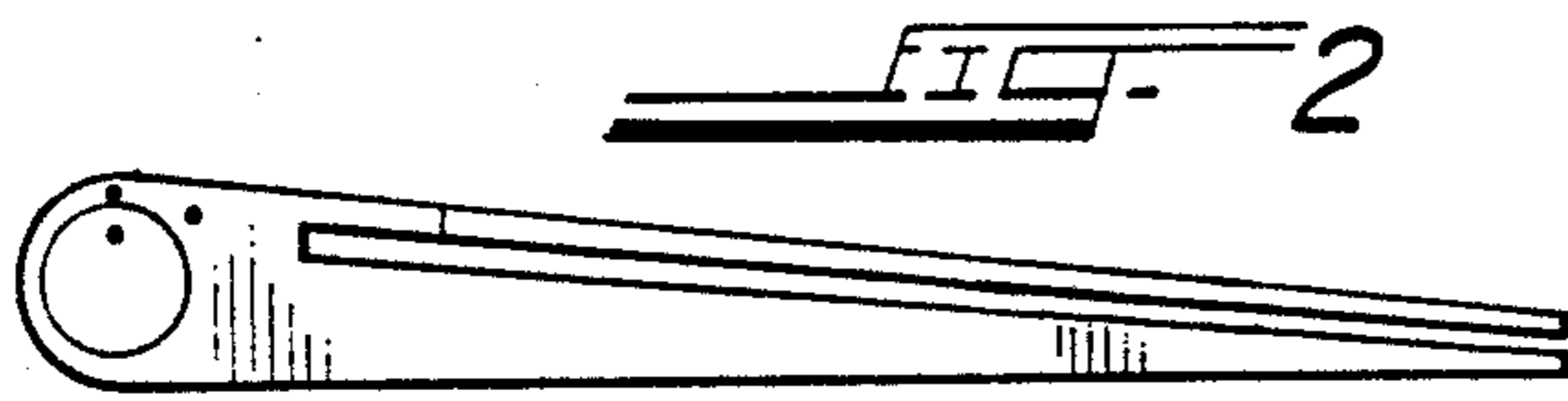
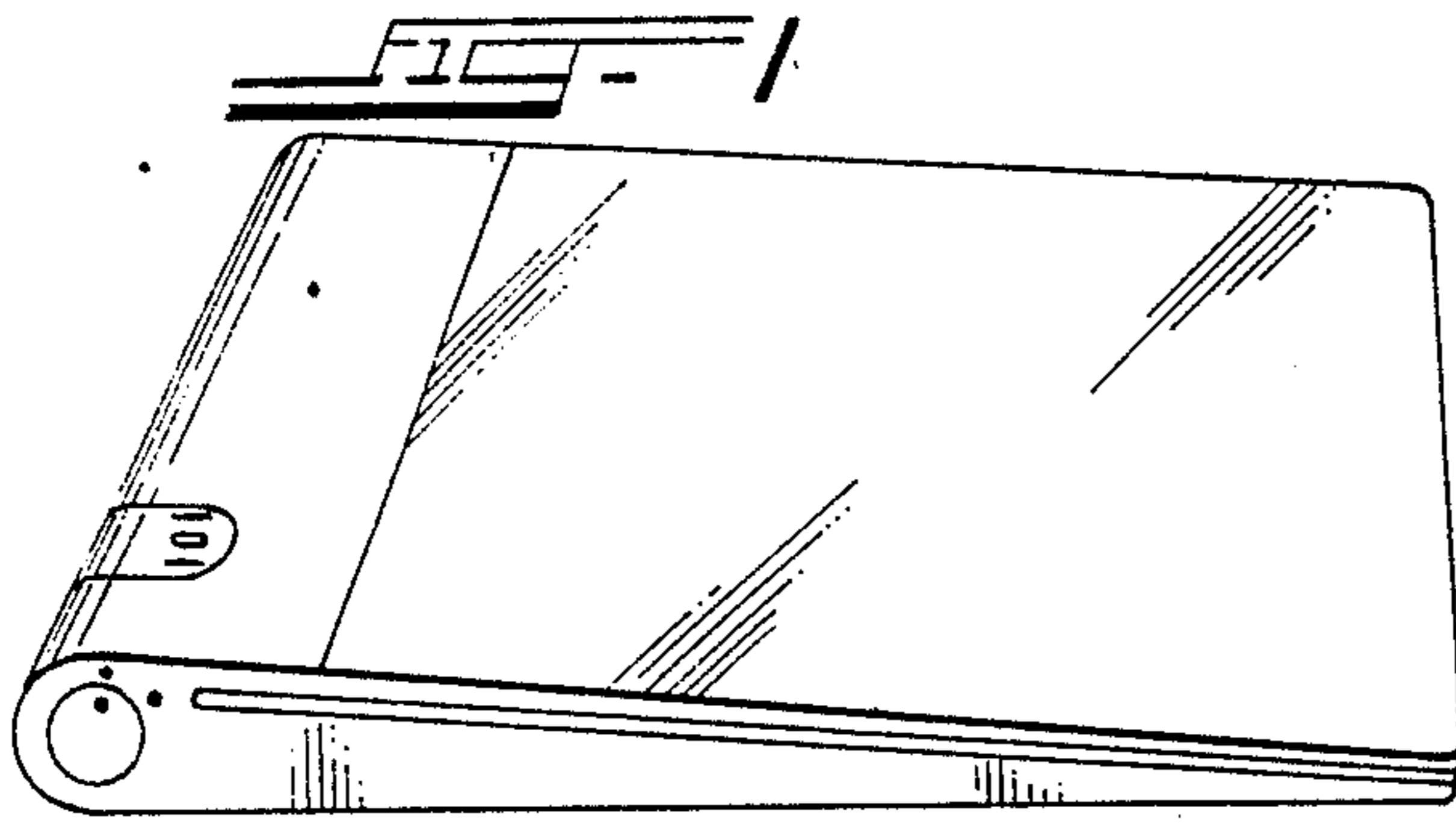

FIG-8

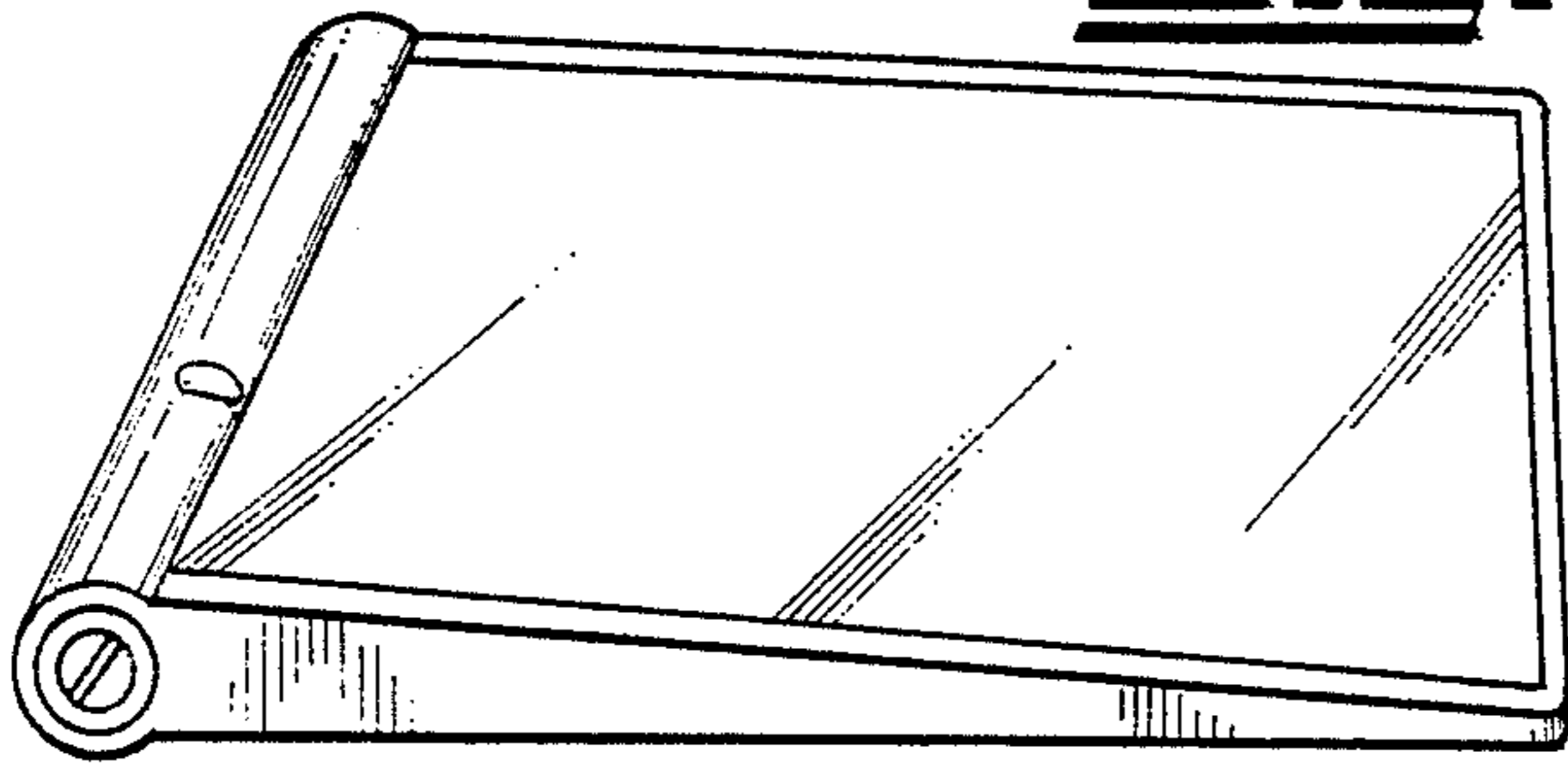

FIG-15

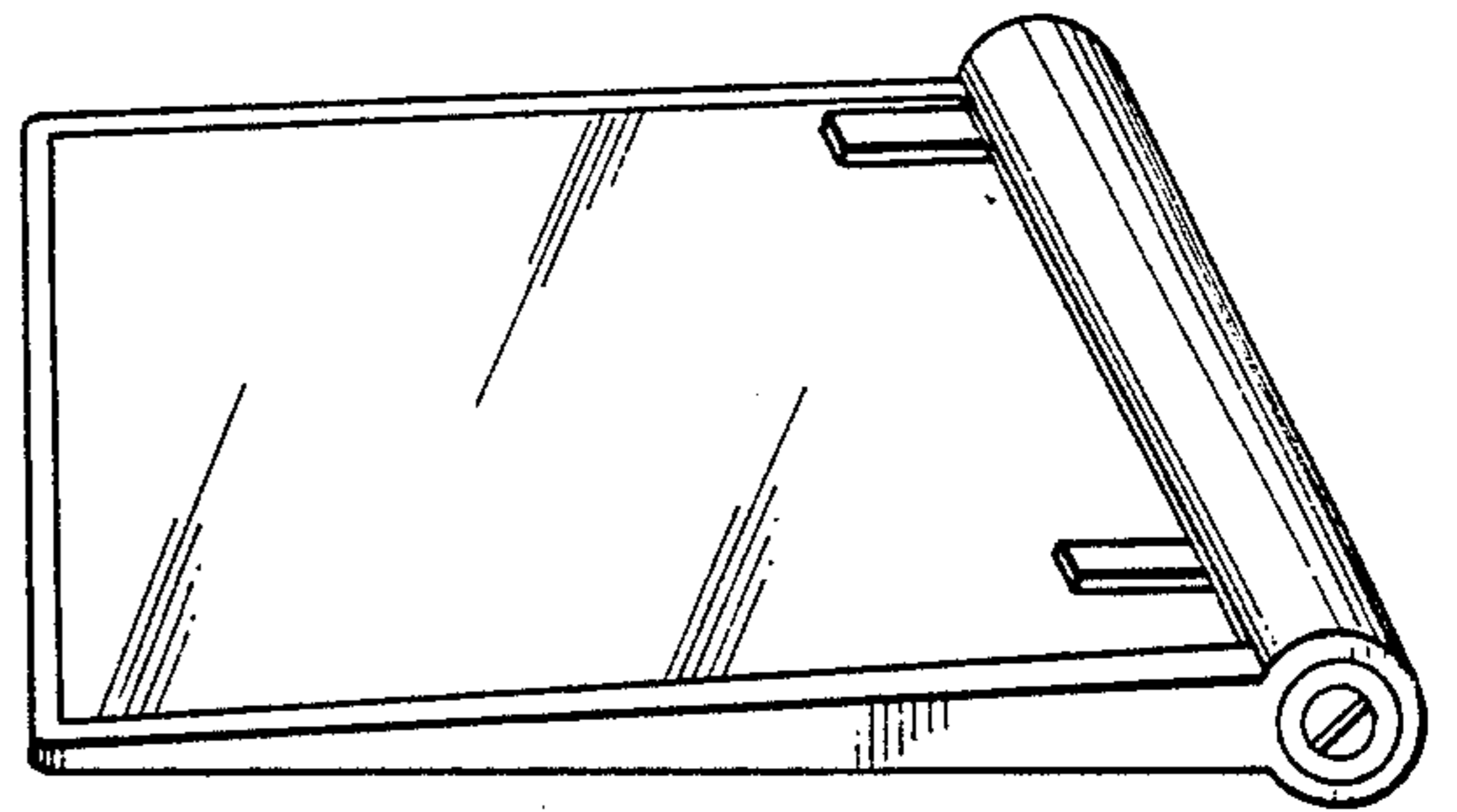

FIG-9



FIG-10

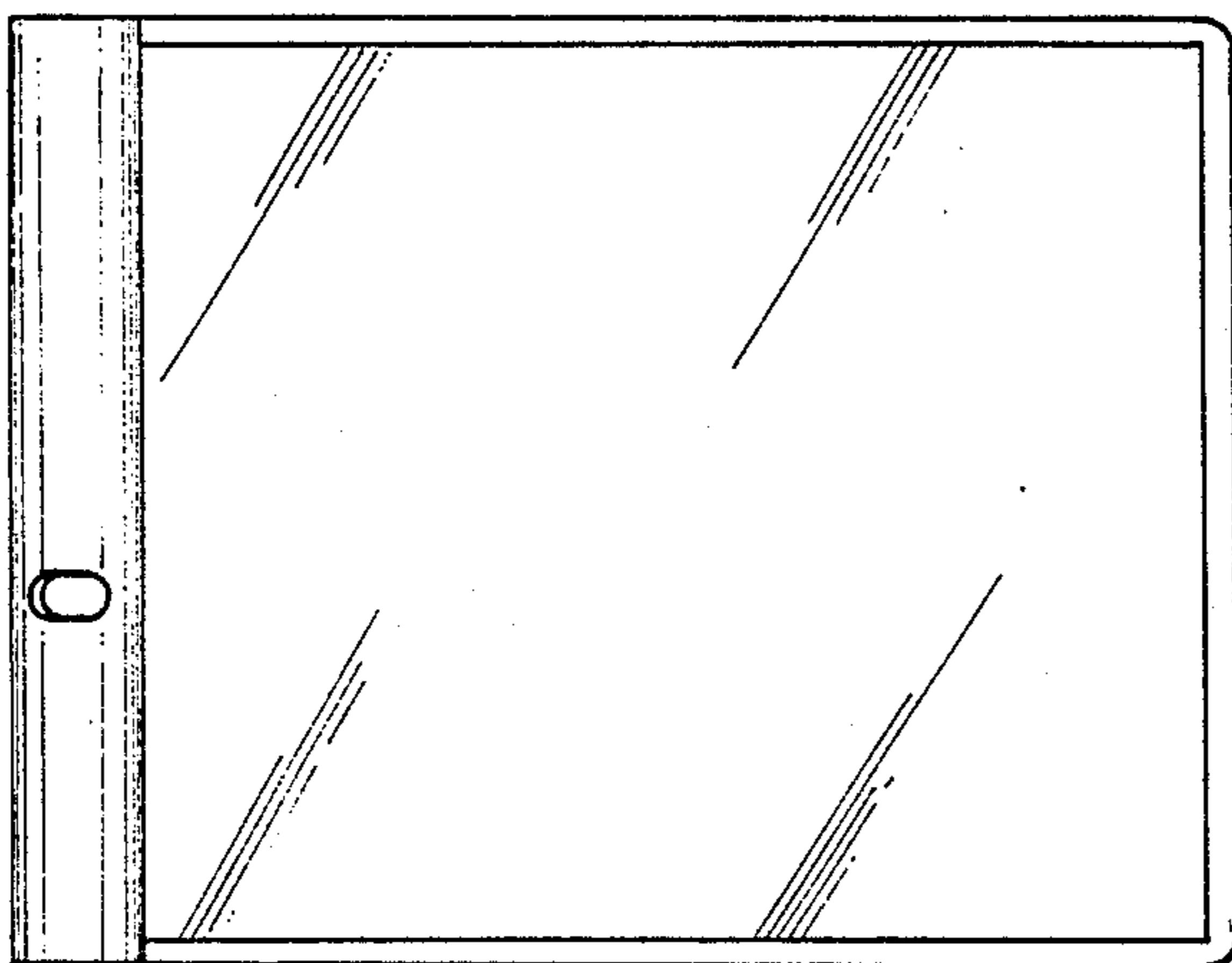

FIG-11

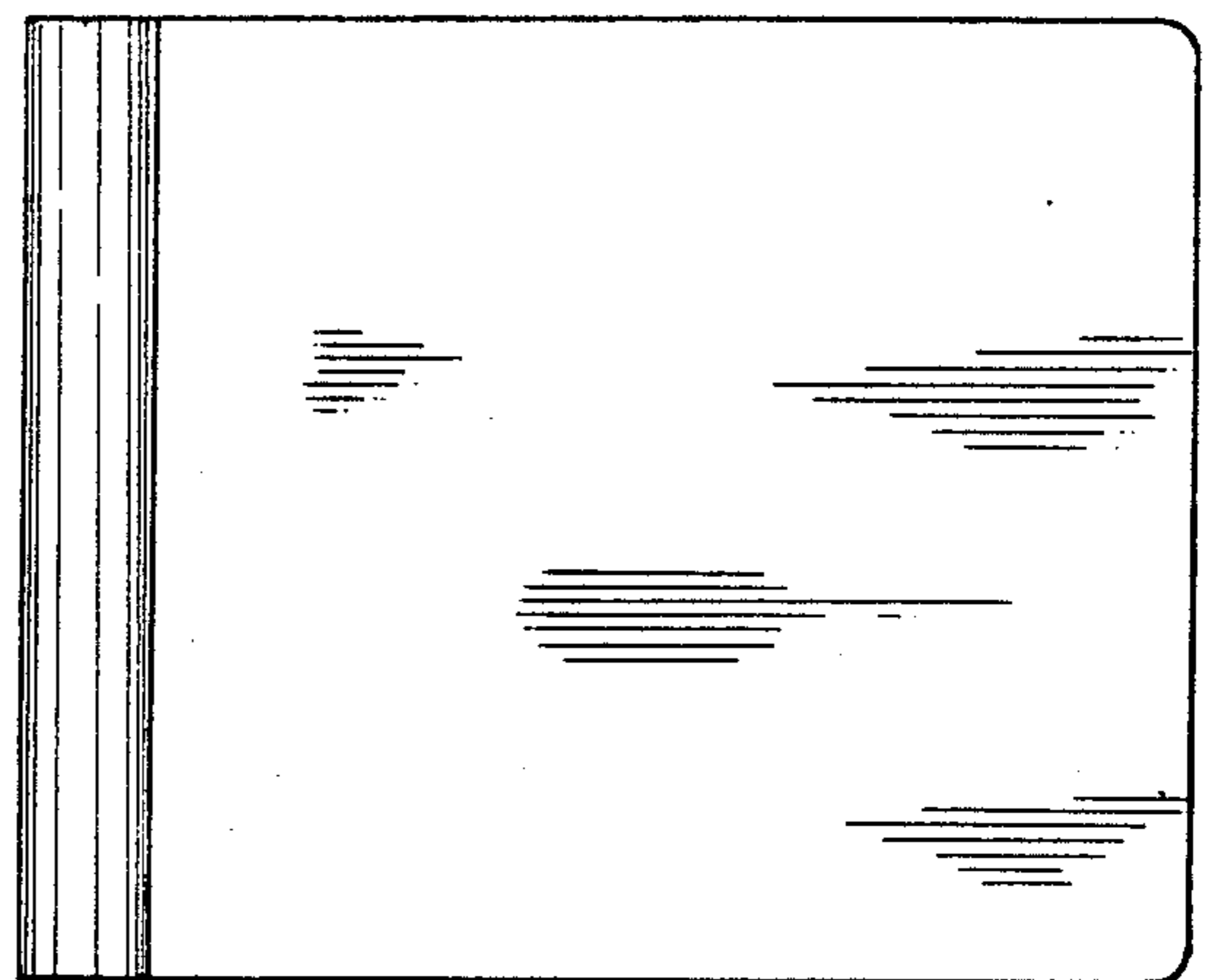

FIG-12



FIG-13

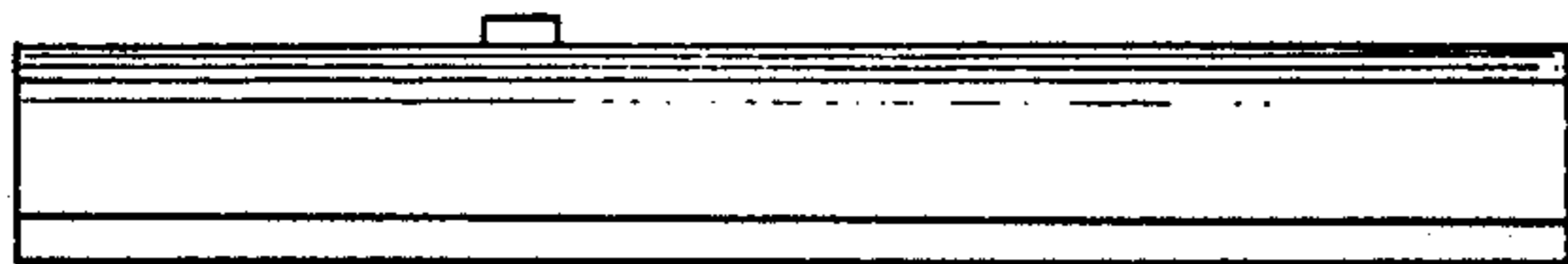

FIG-14

