

[54] **BOWLING GAME BOARD**

[75] **Inventor:** Erland Wikner, Tranas, Sweden
[73] **Assignee:** Stiga Aktiebolag, Tranas, Sweden
[**] **Term:** 14 Years
[21] **Appl. No.:** 225,133
[22] **Filed:** Jul. 20, 1988

[30] **Foreign Application Priority Data**

Feb. 3, 1988 [SE] Sweden 88-0229
[52] **U.S. Cl.** **D21/11**
[58] **Field of Search** D21/1, 11, 233, 14,
D21/5, 7, 8; 273/176, 176 F, 176 FA, 176 FB,
176 H, 178-180

[56] **References Cited**

U.S. PATENT DOCUMENTS

D. 124,351 12/1940 Williams et al. D21/8
D. 138,378 7/1944 Martin, Jr. D21/8
D. 159,928 8/1950 Reising D21/8

739,254 9/1903 Borland D21/8
2,432,824 12/1947 Shetler D21/14

Primary Examiner—A. Hugo Word
Assistant Examiner—R. T. Seifert
Attorney, Agent, or Firm—Beveridge, DeGrandi &
Weilacher

[57] **CLAIM**

The ornamental design for a bowling game board, as shown.

DESCRIPTION

FIG. 1 is a perspective view of a bowling game board showing my new design;
FIG. 2 is a top plan view;
FIG. 3 is a top plan view, shown with the skittles in the stored position;
FIG. 4 is a side elevational view;
FIG. 5 is a side elevational view, showing the side opposite that shown in FIG. 4;
FIG. 6 is an end elevational view; and
FIG. 7 is an end elevational view showing the side opposite that shown in FIG. 6.

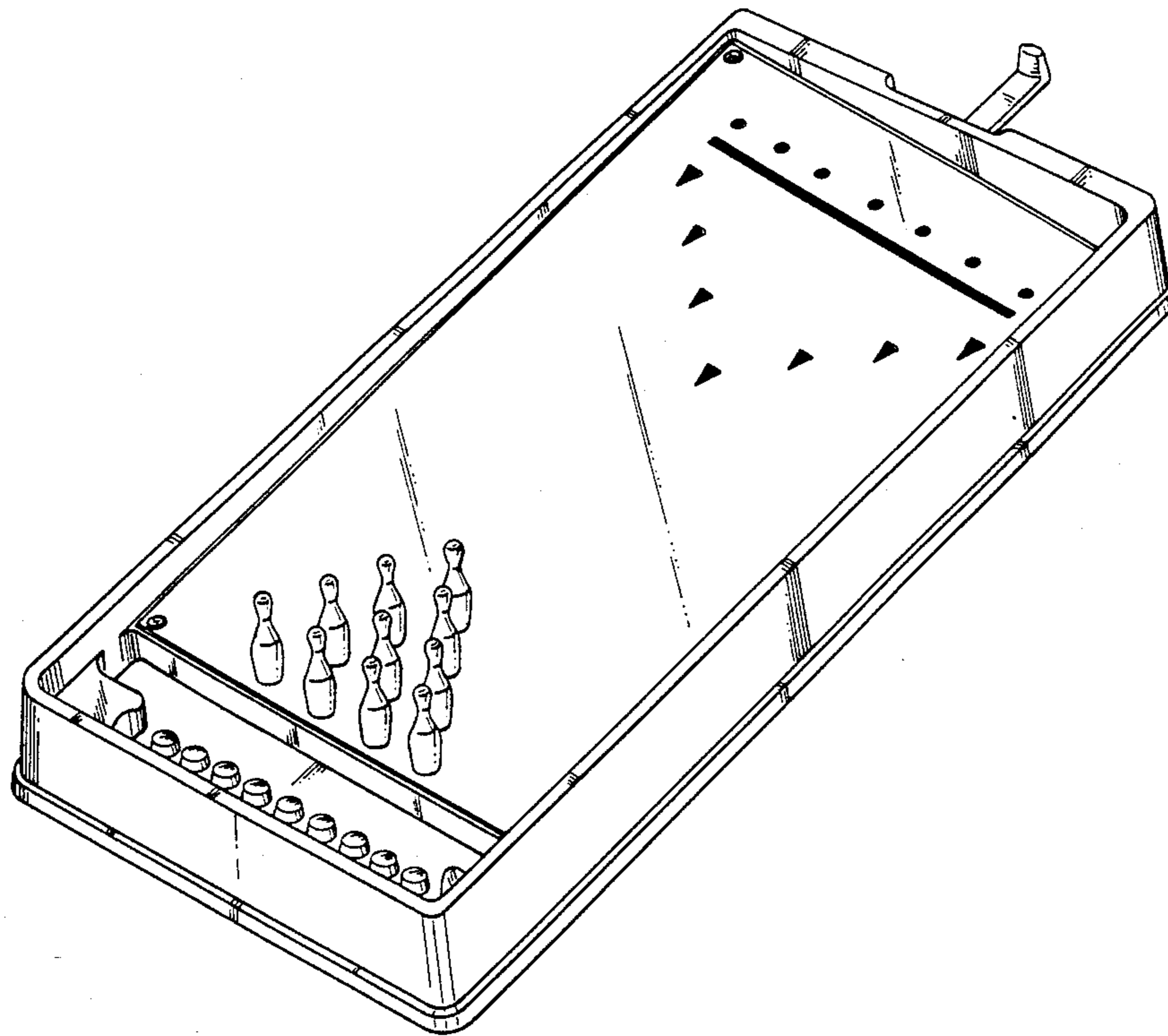

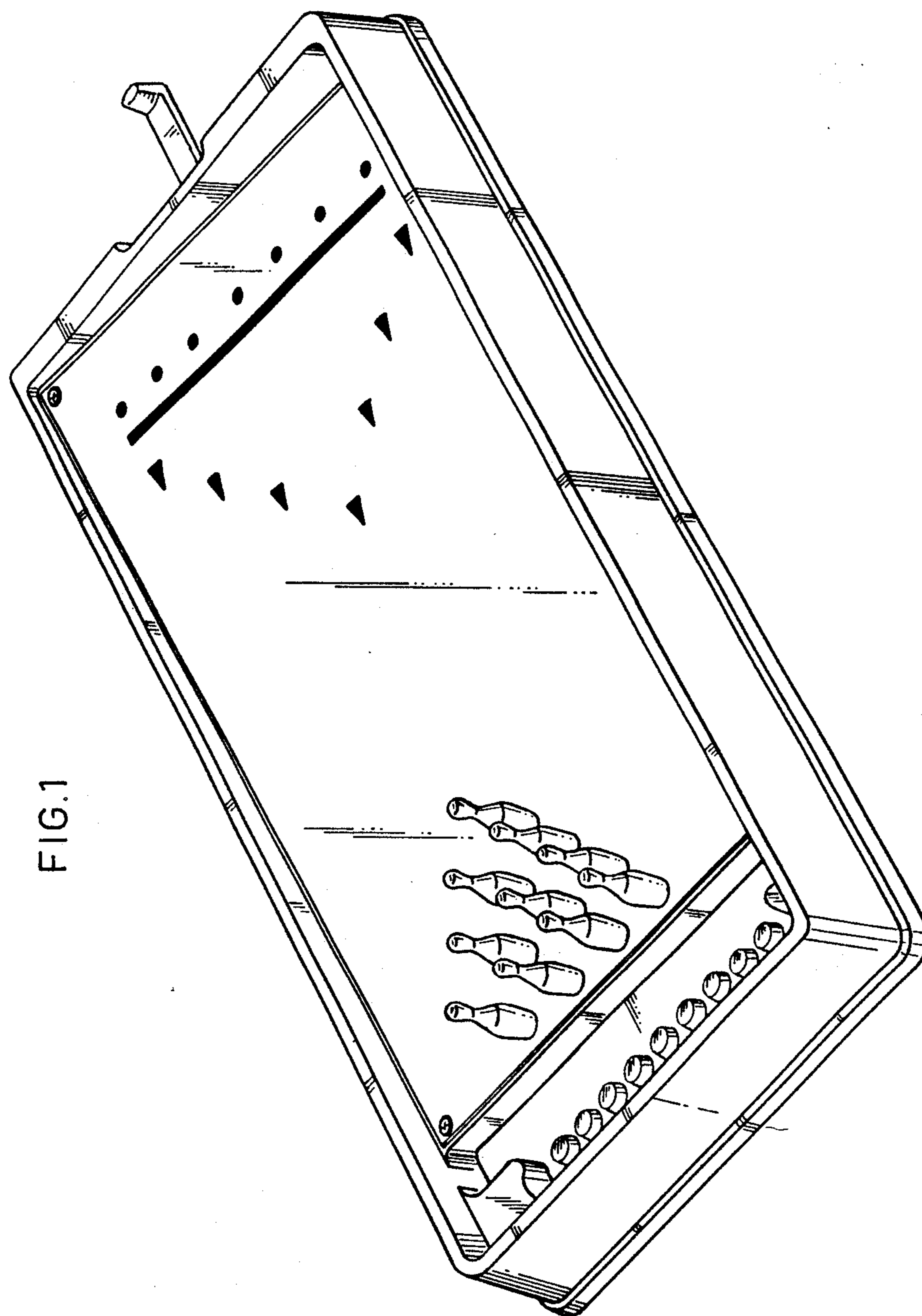

FIG.1

FIG. 2

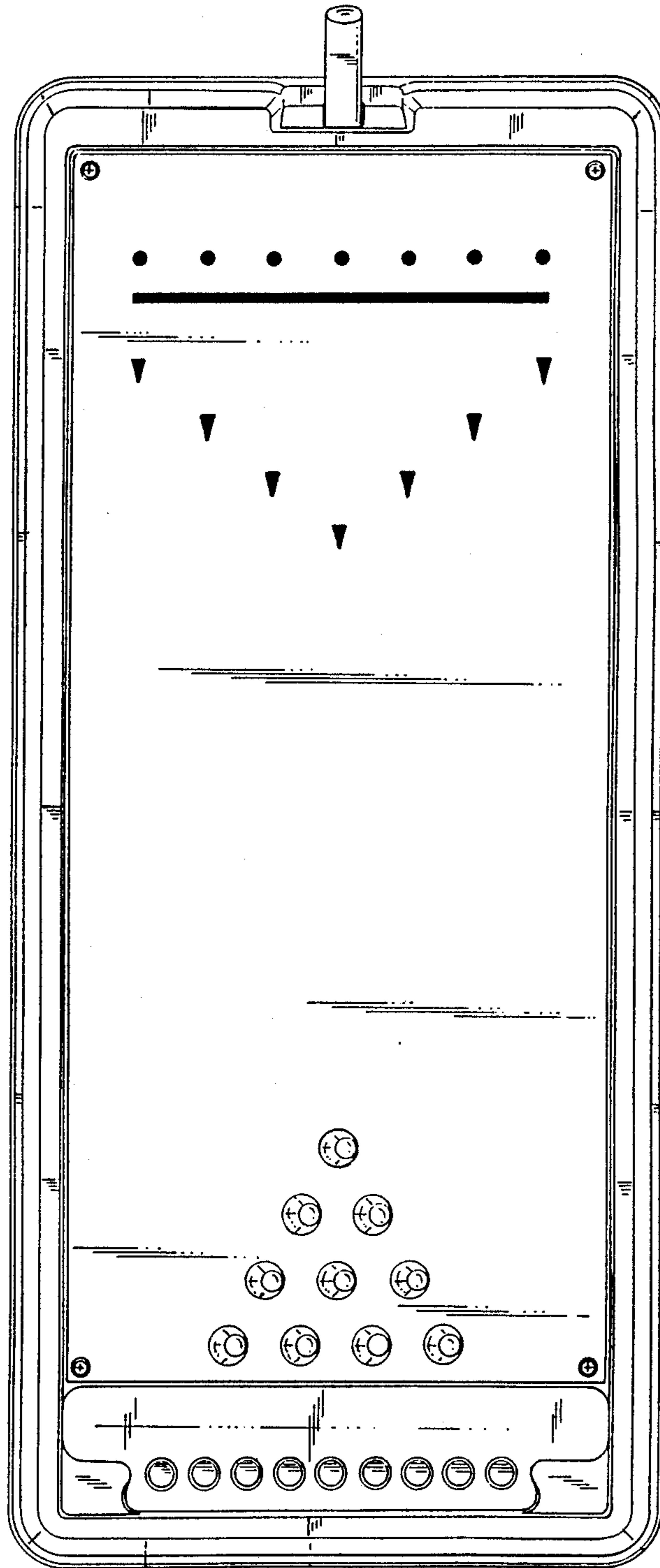

FIG. 3

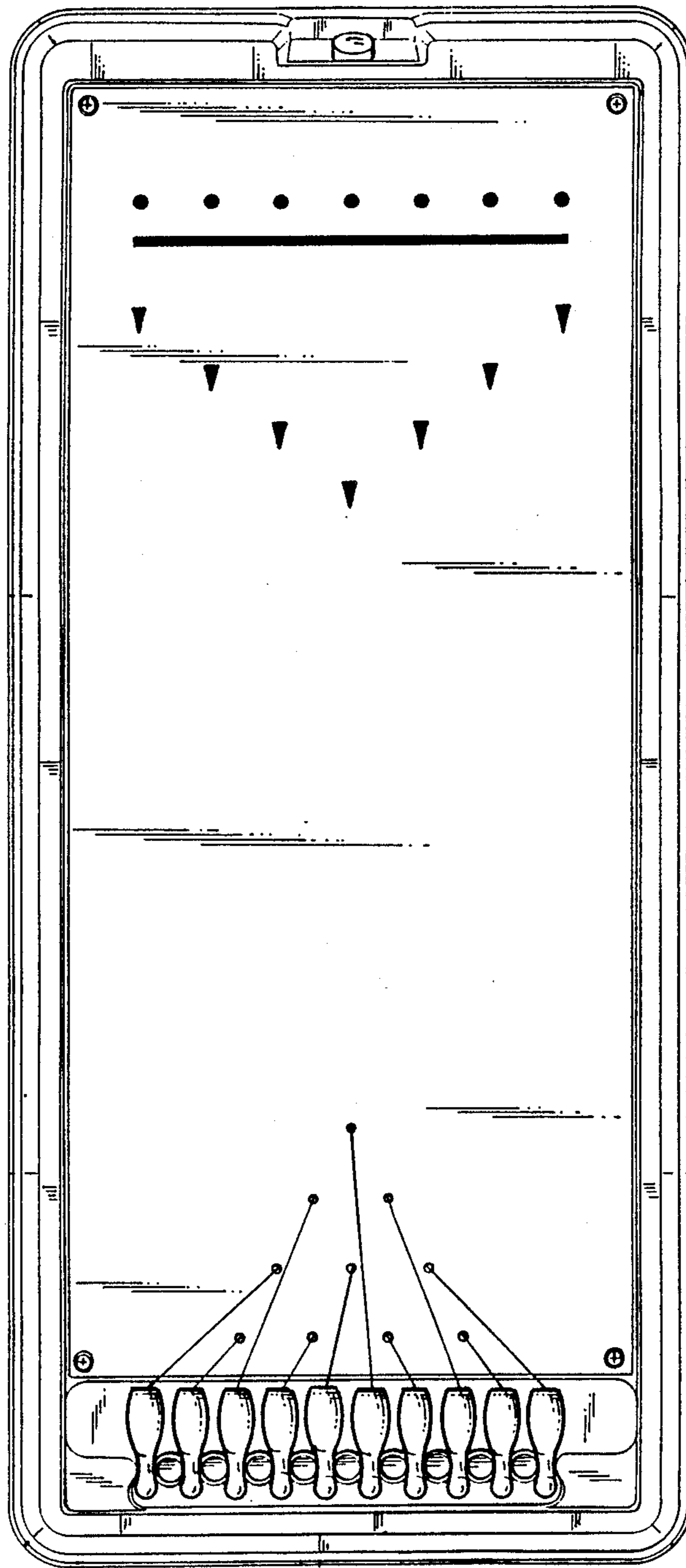

FIG. 4

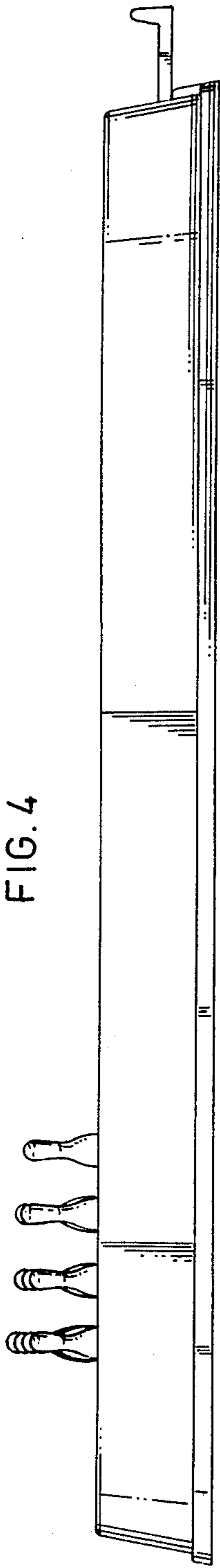

FIG. 5

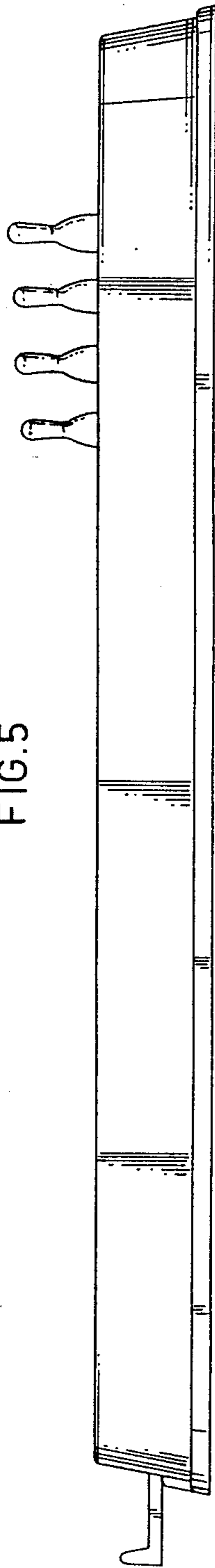

FIG. 6

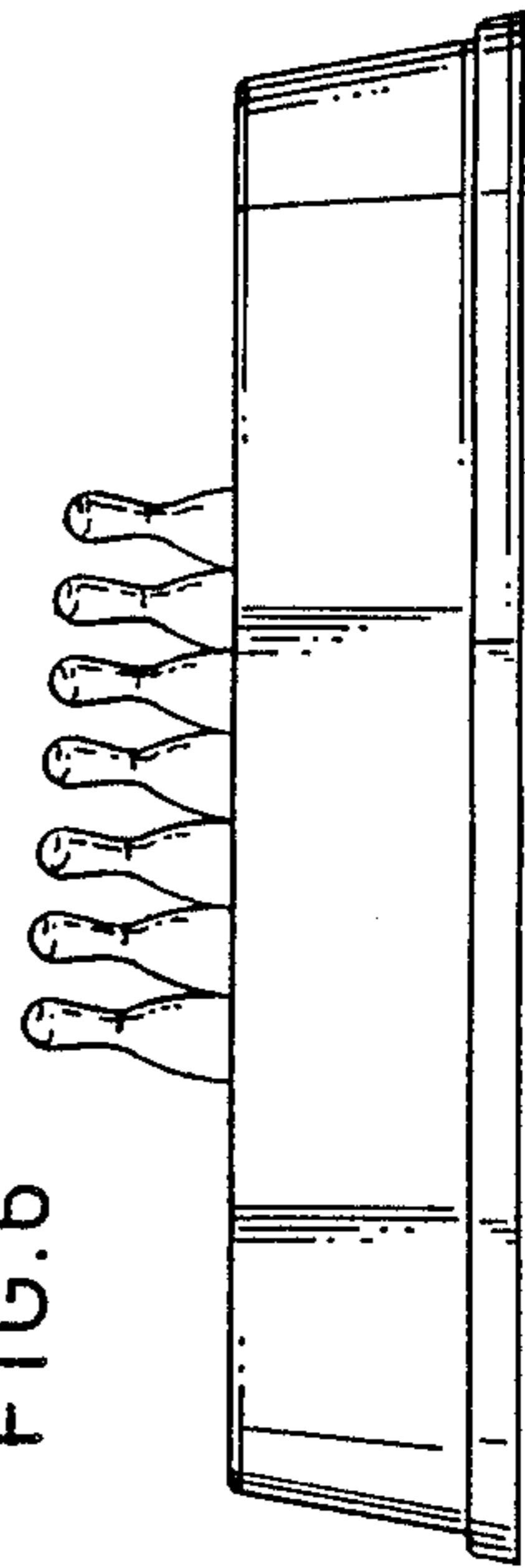

FIG. 7

