

United States Patent [19]

Komada et al.

[11] Patent Number: **Des. 310,539**

[45] Date of Patent: **** Sep. 11, 1990**

[54] **DEVELOPING DEVICE FOR COPYING MACHINE**

[75] Inventors: **Takeshi Komada, Yokohama; Yutaka Okayama, Tokyo, both of Japan**

[73] Assignee: **Canon Kabushiki Kaisha, Tokyo, Japan**

[**] Term: **14 Years**

[21] Appl. No.: **221,179**

[22] Filed: **Jul. 19, 1988**

[30] **Foreign Application Priority Data**

Jan. 22, 1988 [JP] Japan 63-2205

[52] U.S. Cl. **D18/40**

[58] Field of Search D18/40, 43; 355/245, 355/260

[56] **References Cited**

U.S. PATENT DOCUMENTS

D. 298,335 11/1988 Masaki et al. D18/40
D. 298,336 11/1988 Masaki D18/43

4,849,791 7/1989 Hagihara et al. 355/260

FOREIGN PATENT DOCUMENTS

0061845 4/1984 Japan 355/245
0044774 2/1987 Japan 355/260

Primary Examiner—Bruce W. Dunkins
Assistant Examiner—Caron D. Veynar
Attorney, Agent, or Firm—Fitzpatrick, Cella, Harper & Scinto

[57] CLAIM

The ornamental design for a developing device for copying machine, as shown and described.

DESCRIPTION

FIG. 1 is a right side elevational view of a developing device for copying machine showing our new design; FIG. 2 is a left side elevational view thereof; FIG. 3 is a top plan view thereof; FIG. 4 is a bottom plan view thereof; FIG. 5 is a front elevational view thereof; FIG. 6 is a rear elevational view thereof; FIG. 7 is a right front perspective view thereof.

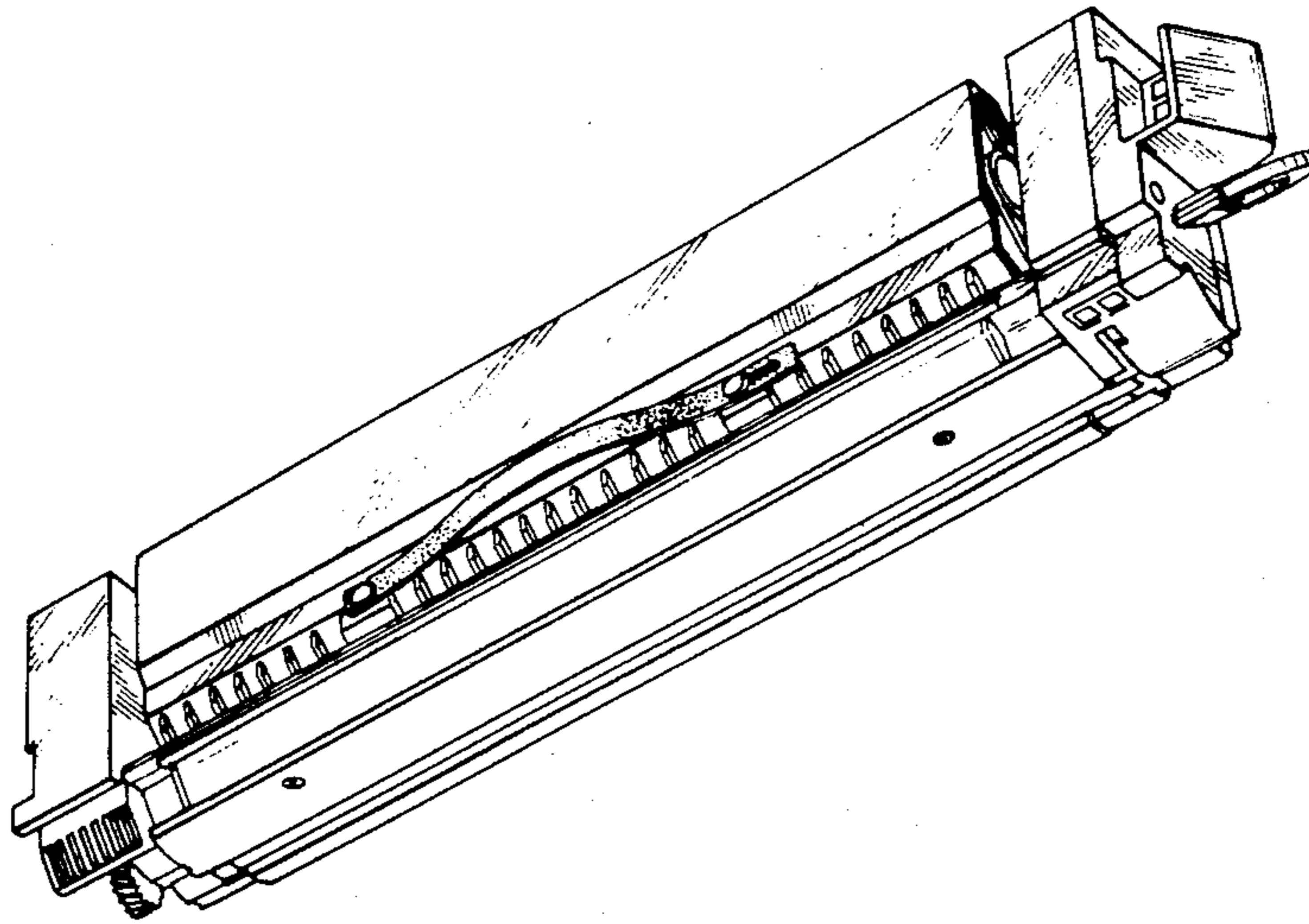

FIG. 1

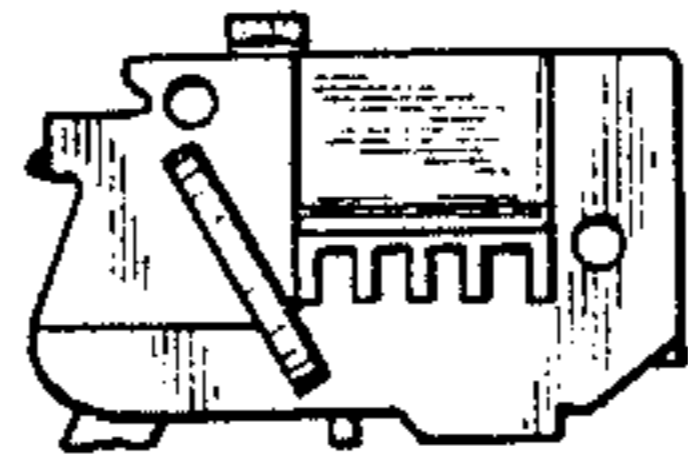

FIG. 2

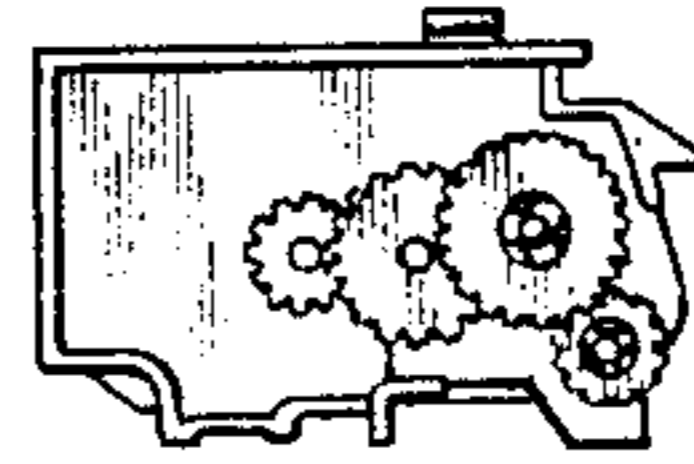

FIG. 3

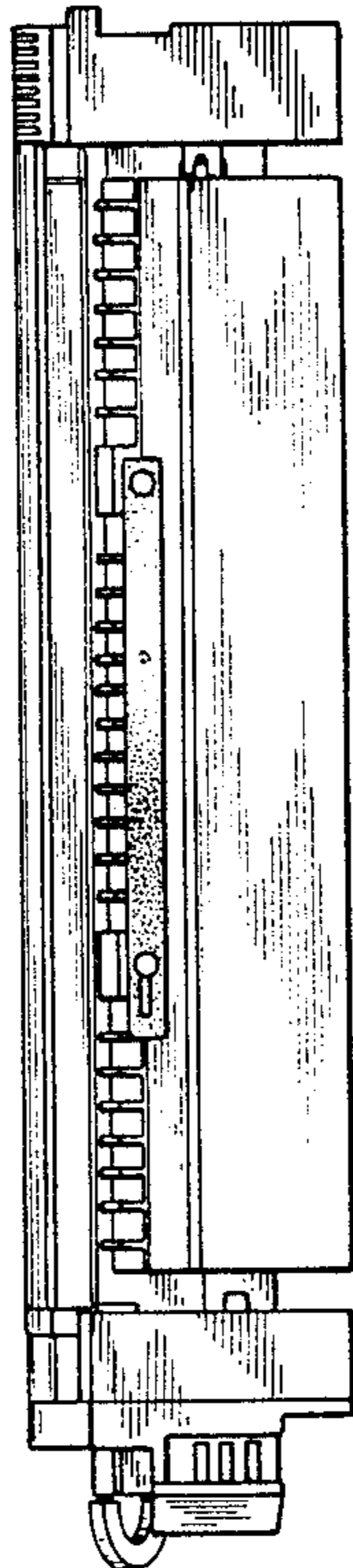

FIG. 4

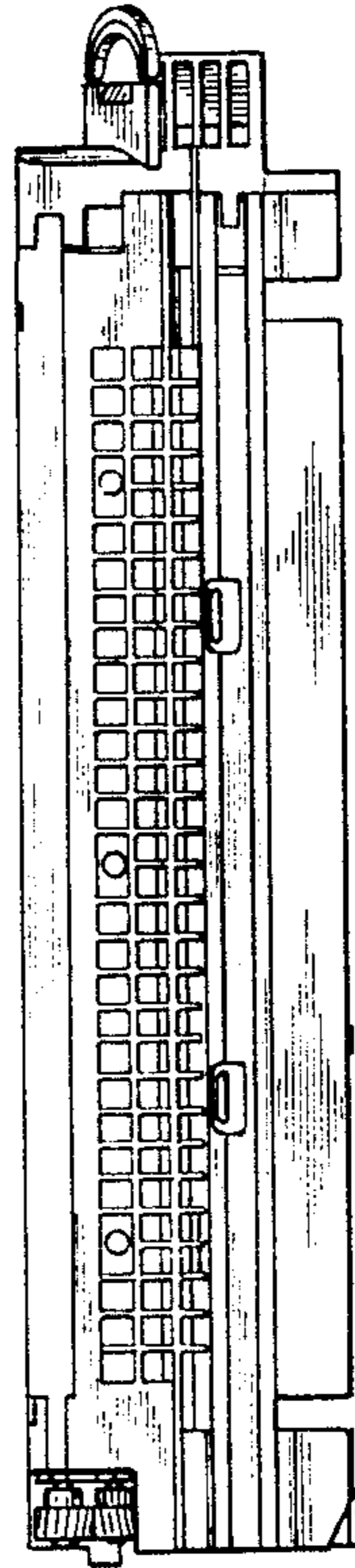

FIG. 5

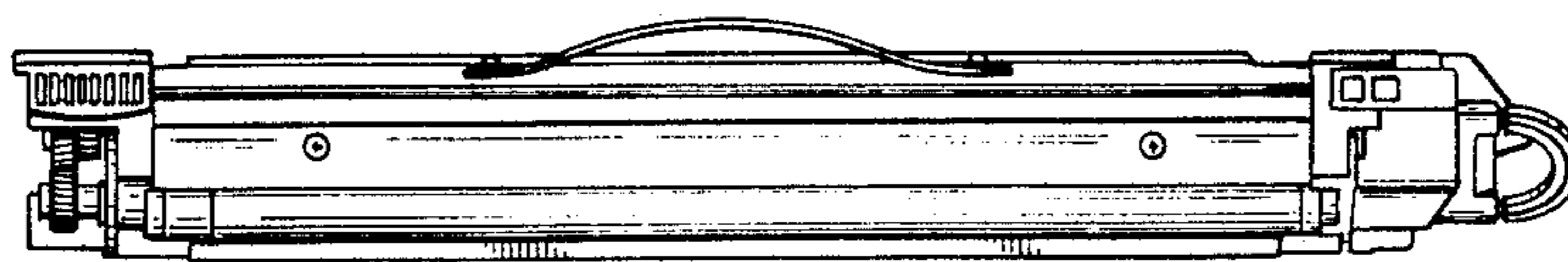

FIG. 6

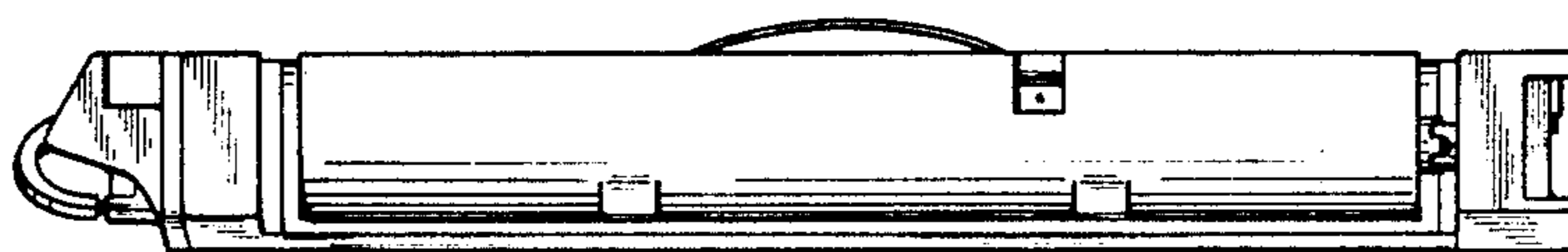

FIG. 7

