

[54] **TRACTOR TRAILER AIR CHUTE**

[76] **Inventor: Lyle W. Brys, 1465 Glencoe, Denver, Colo. 80220**

[**] **Term: 14 Years**

[21] **Appl. No.: 72,845**

[22] **Filed: Jul. 14, 1987**

[52] **U.S. Cl. D12/97; D12/181**

[58] **Field of Search D12/181, 96, 97; 296/180.4, 181; 98/6, 2.11, 2.14**

[56] **References Cited**

U.S. PATENT DOCUMENTS

- D. 283,218 4/1986 Karapetian D12/181
- 4,399,737 8/1983 Severson 98/6.

*Primary Examiner—James M. Gandy
Attorney, Agent, or Firm—Gregg I. Anderson*

[57] **CLAIM**

The ornamental design for a tractor trailer air chute, as shown and described.

DESCRIPTION

FIG. 1 is a reduced side elevational view of the tractor trailer air chute showing my new design, it being understood that the broken lines are for illustrative purposes only and form no part of the claimed design;

FIG. 2 is an enlarged top perspective view thereof;

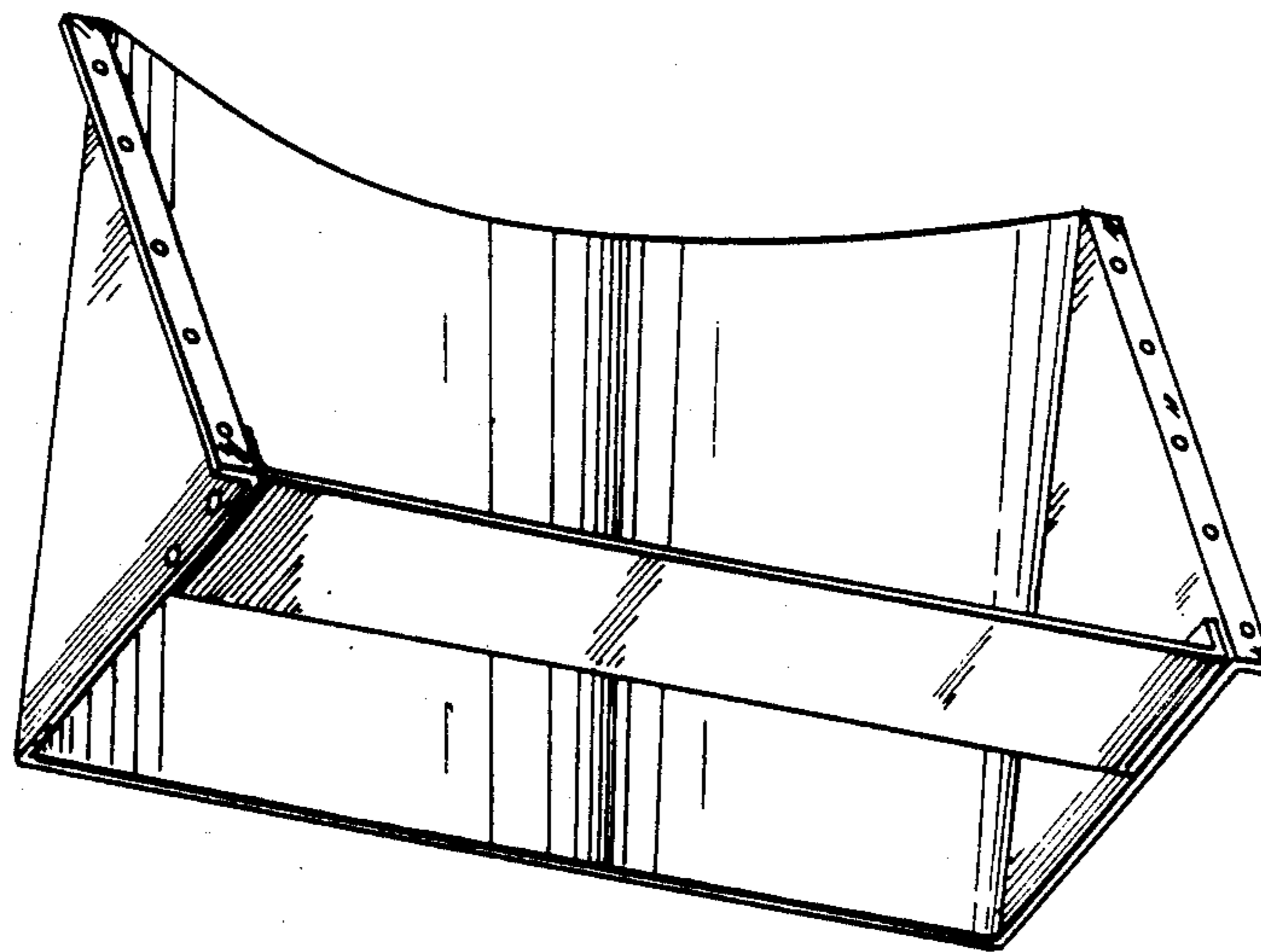
FIG. 3 is an enlarged rear elevational view thereof;

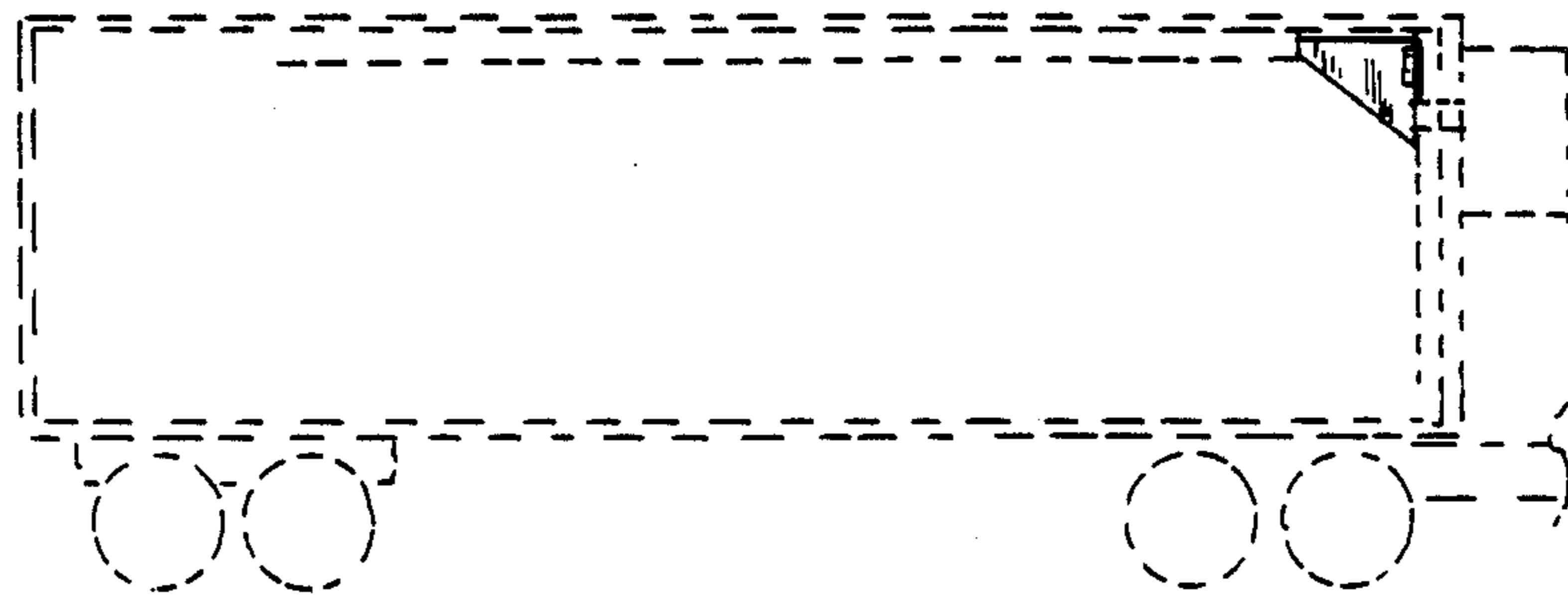
FIG. 4 is an enlarged front elevational view thereof;

FIG. 5 is an enlarged top plan view thereof;

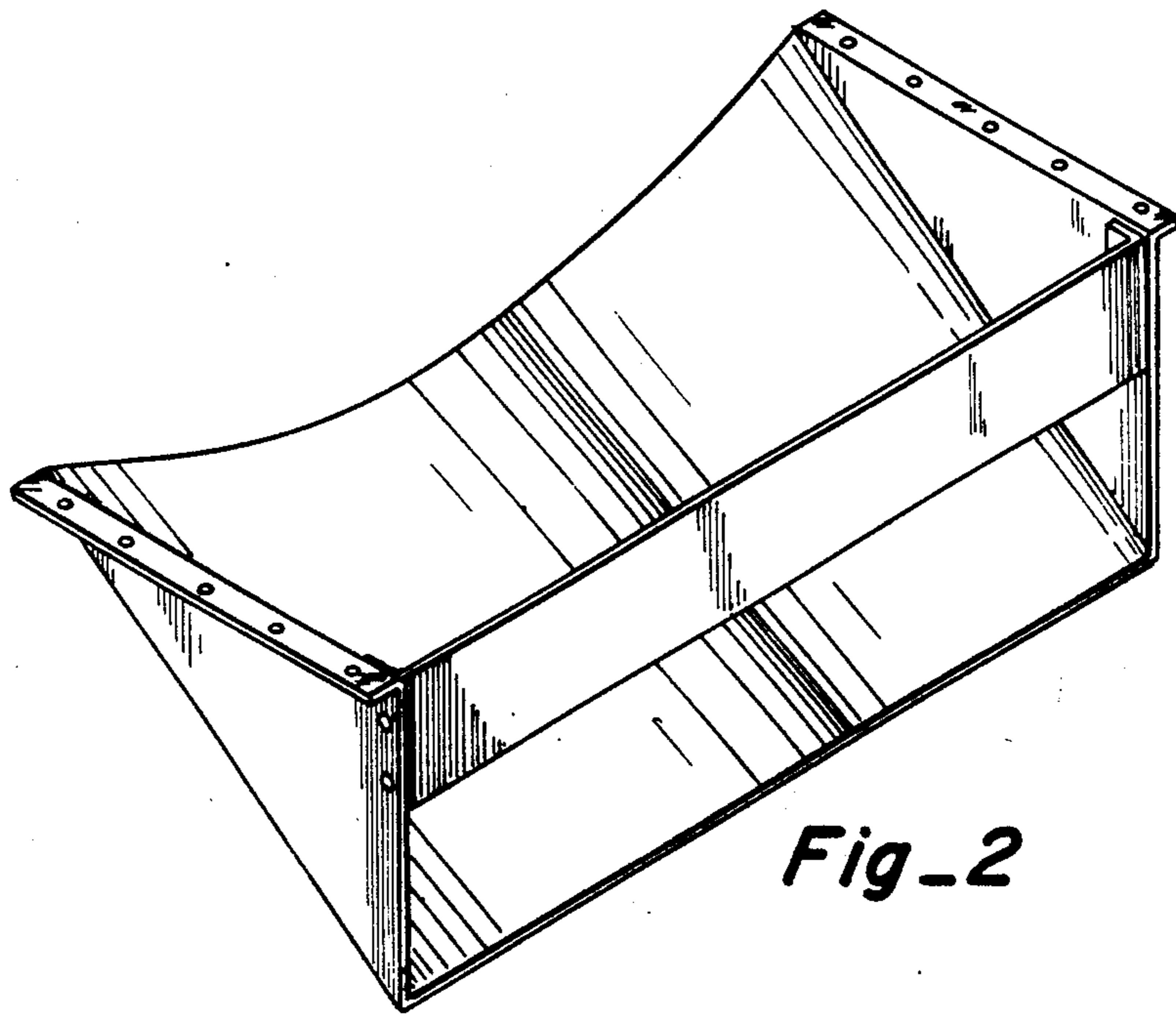
FIG. 6 is an enlarged bottom plan view thereof;

FIG. 7 is an enlarged side elevational view thereof.

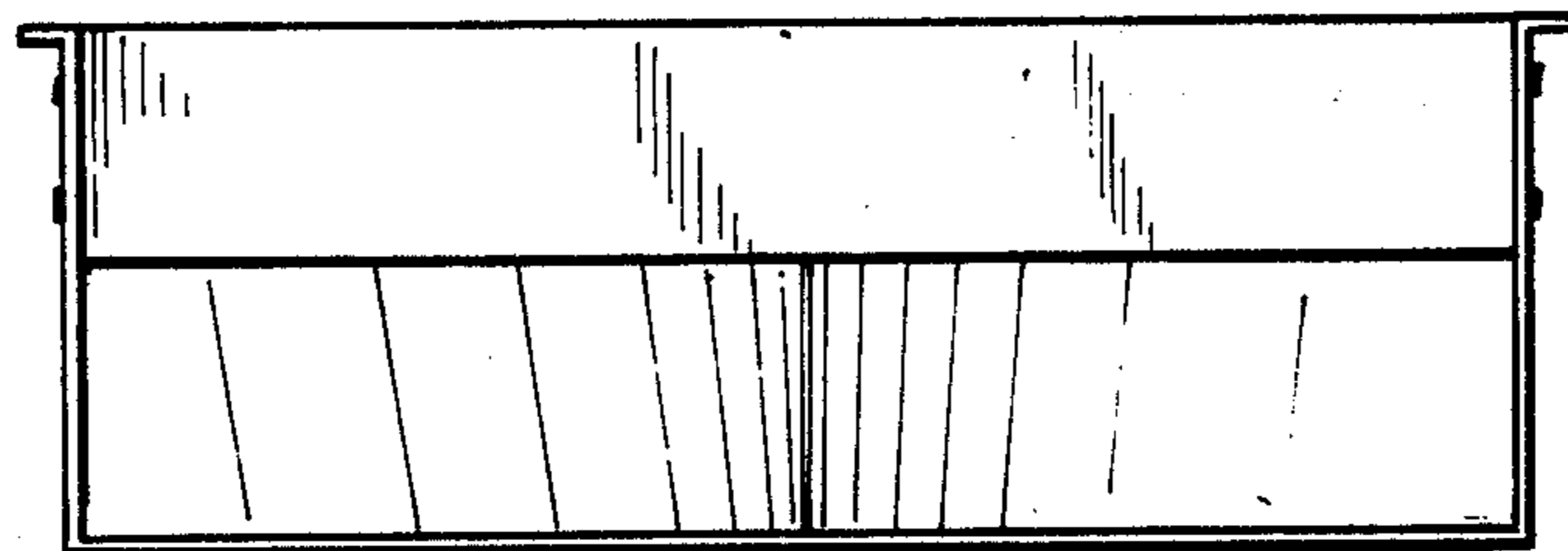




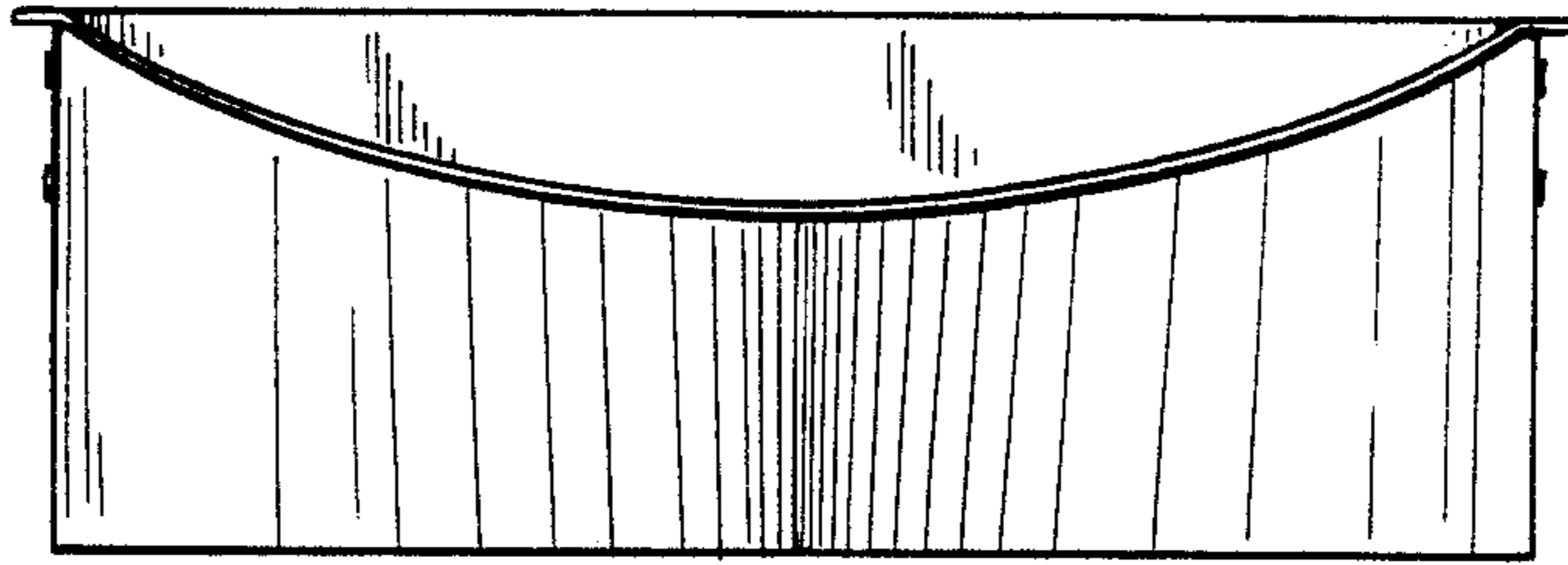
Fig_1



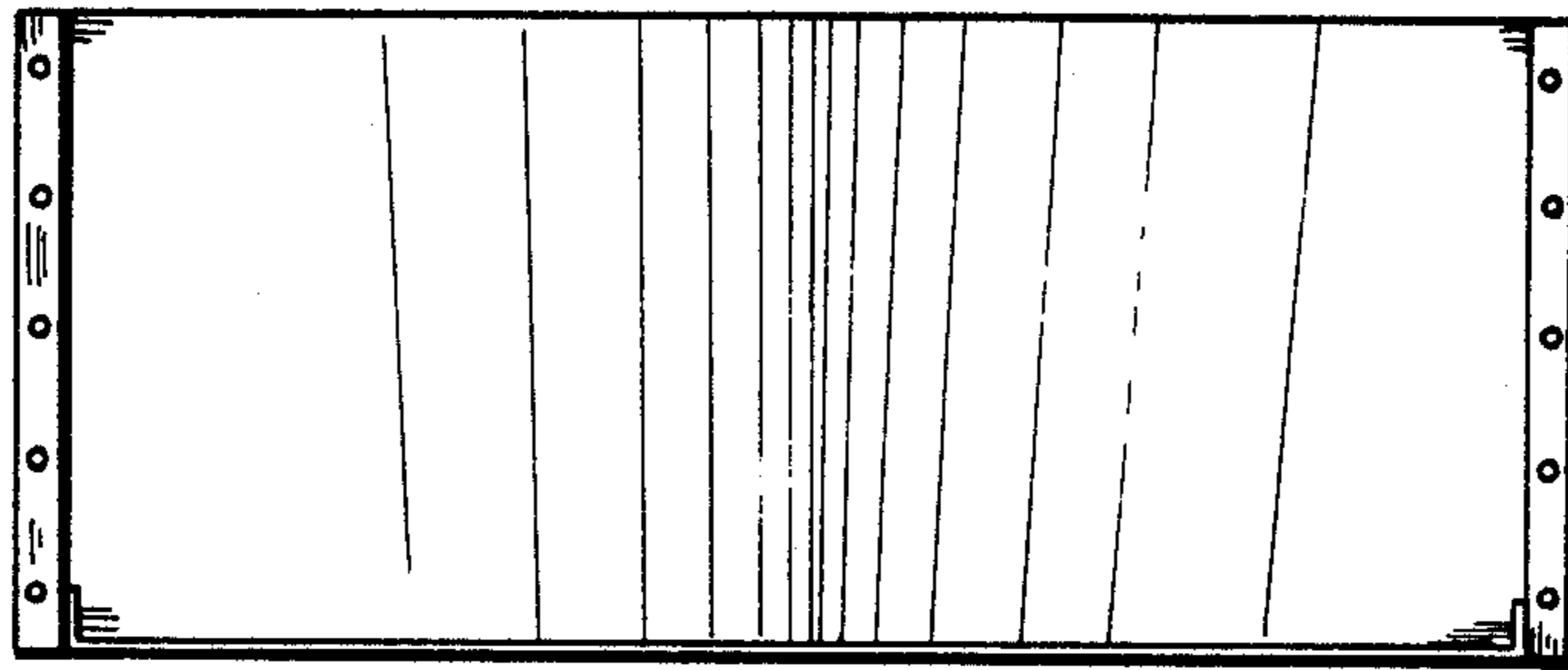
Fig_2



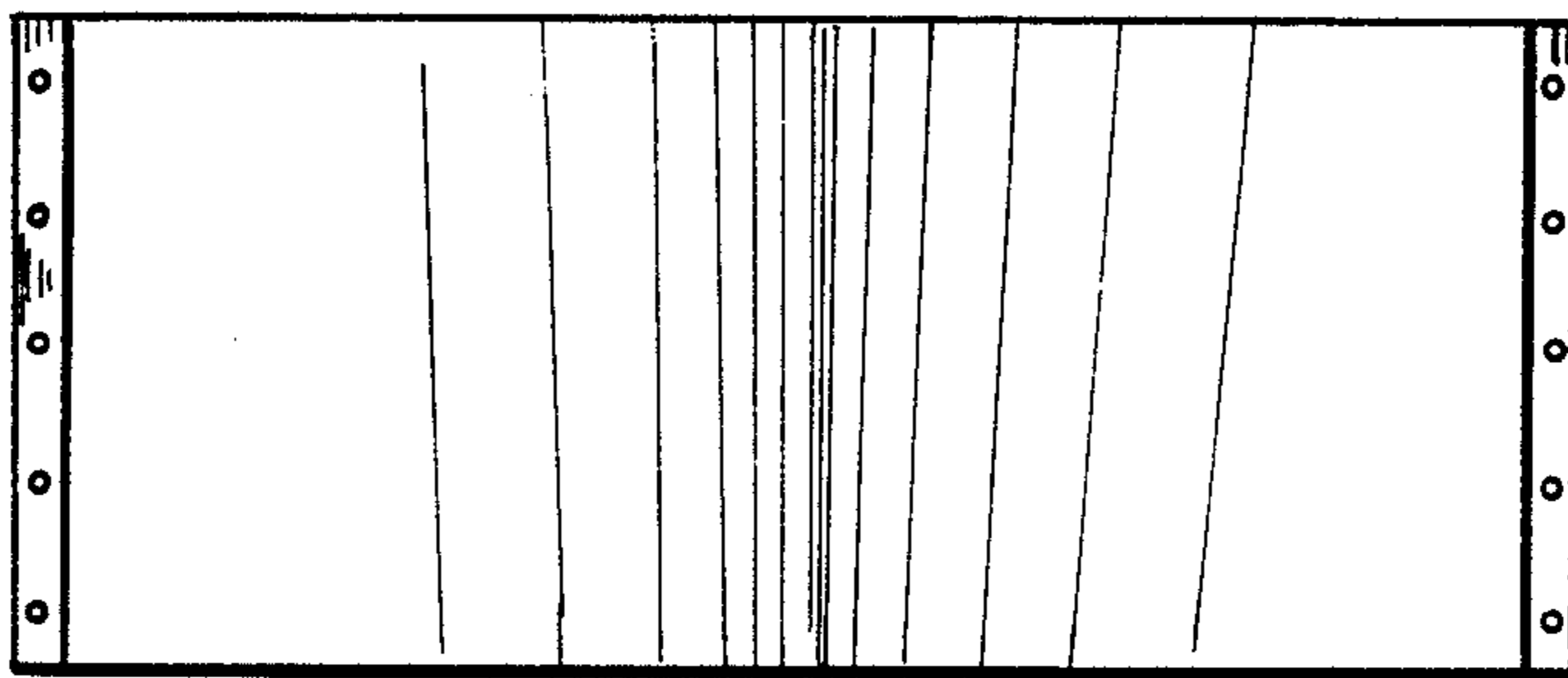
Fig_3



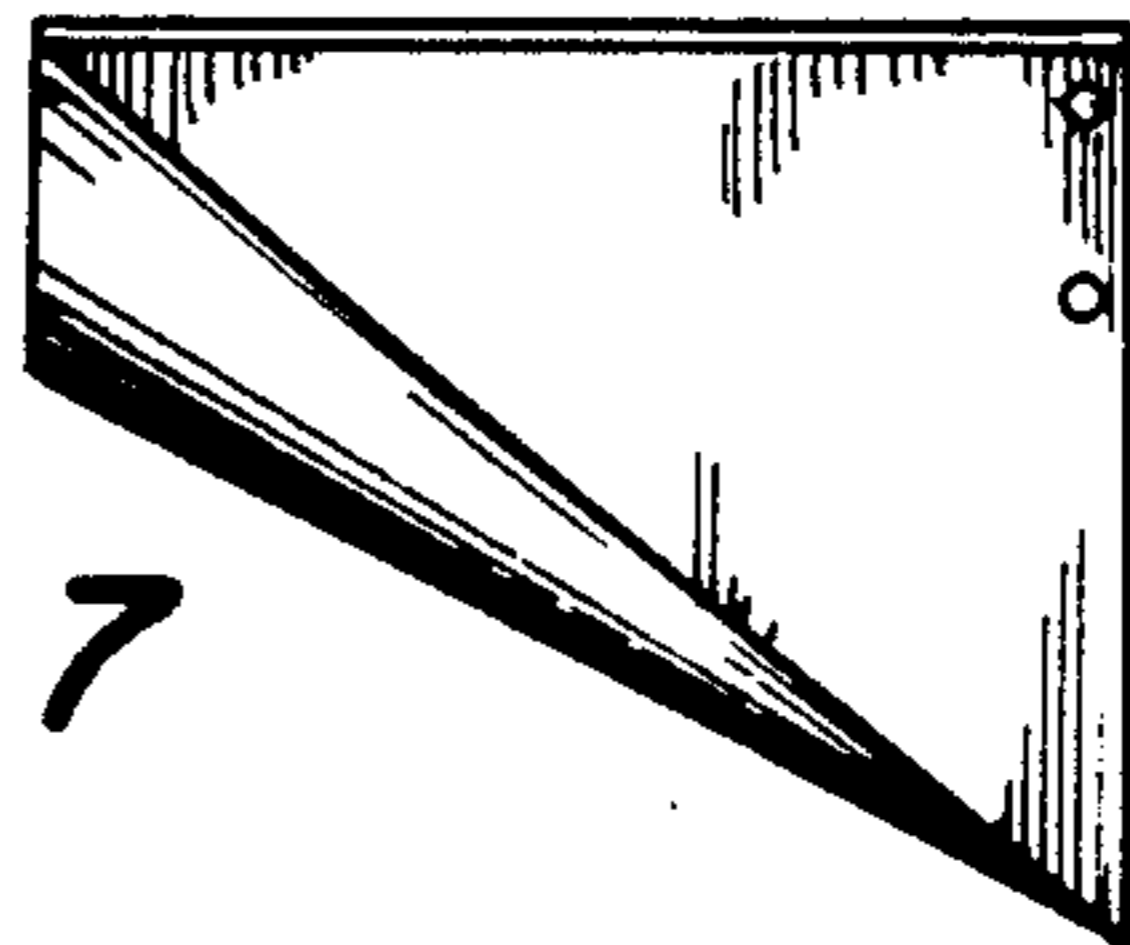
Fig_4



Fig_5



Fig_6



Fig_7