

[54] **EYESHIELD**

[76] **Inventor: John P. Russell, 1000 Main St., Gardendale, Ala. 35071**

[*] **Notice: The portion of the term of this patent subsequent to Sep. 4, 2004 has been disclaimed.**

[**] **Term: 14 Years**

[21] **Appl. No.: 78,543**

[22] **Filed: Jul. 28, 1987**

[52] **U.S. Cl. D16/107; D16/108; D16/116; D24/49**

[58] **Field of Search D16/102-122, D16/125-127; 351/41, 44-49, 51-53, 56-60, 63, 65, 70, 83, 85, 87, 90, 103, 110, 156; 2/12, 13, 15, 426, 439, 450**

[56] **References Cited**

U.S. PATENT DOCUMENTS

- D. 144,560 4/1946 Hansen D16/115
- D. 145,288 7/1946 Cicco D16/102
- D. 202,130 8/1965 Mitchell D16/111

- D. 210,422 3/1968 Mitchell D16/102
- 2,714,717 8/1955 Allman D16/115 X
- 4,494,251 1/1985 Ainsworth et al. 2/426
- 4,779,291 10/1988 Russell 351/41

FOREIGN PATENT DOCUMENTS

- 21468 9/1882 Fed. Rep. of Germany 2/426
- 501739 11/1954 Italy 351/41

Primary Examiner—Bruce W. Dunkins
Assistant Examiner—Clare E. Heflin
Attorney, Agent, or Firm—George A. Bode

[57] **CLAIM**

The ornamental design for an eyeshield, as shown and described.

DESCRIPTION

FIG. 1 is a top perspective view of an eyeshield showing my new design;
FIG. 2 is a front elevational view thereof;
FIG. 3 is bottom plan view thereof;
FIG. 4 is side elevational view thereof, the opposite side being a mirror image;
FIG. 5 is a rear elevational view thereof; and,
FIG. 6 is a top plan view thereof.

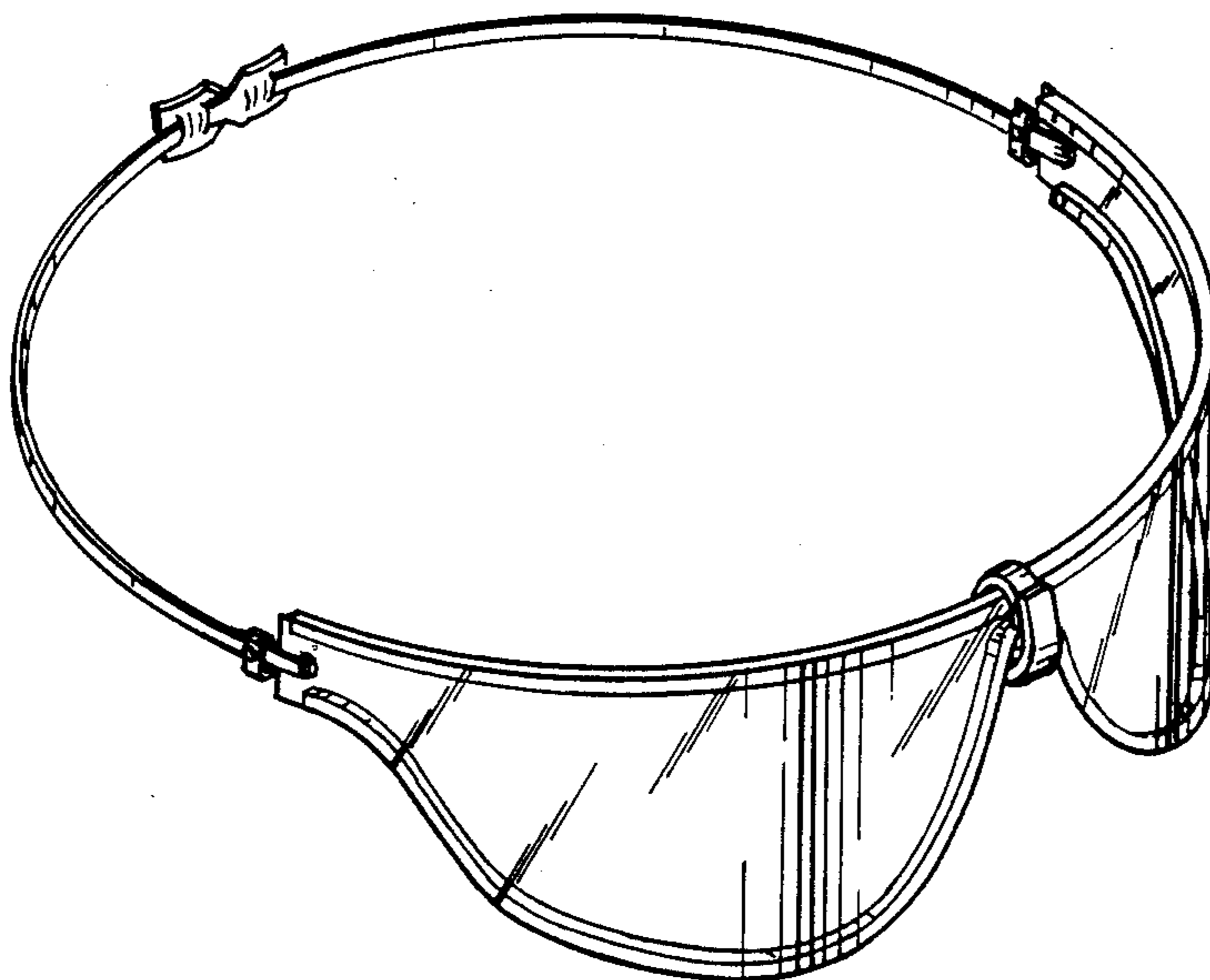

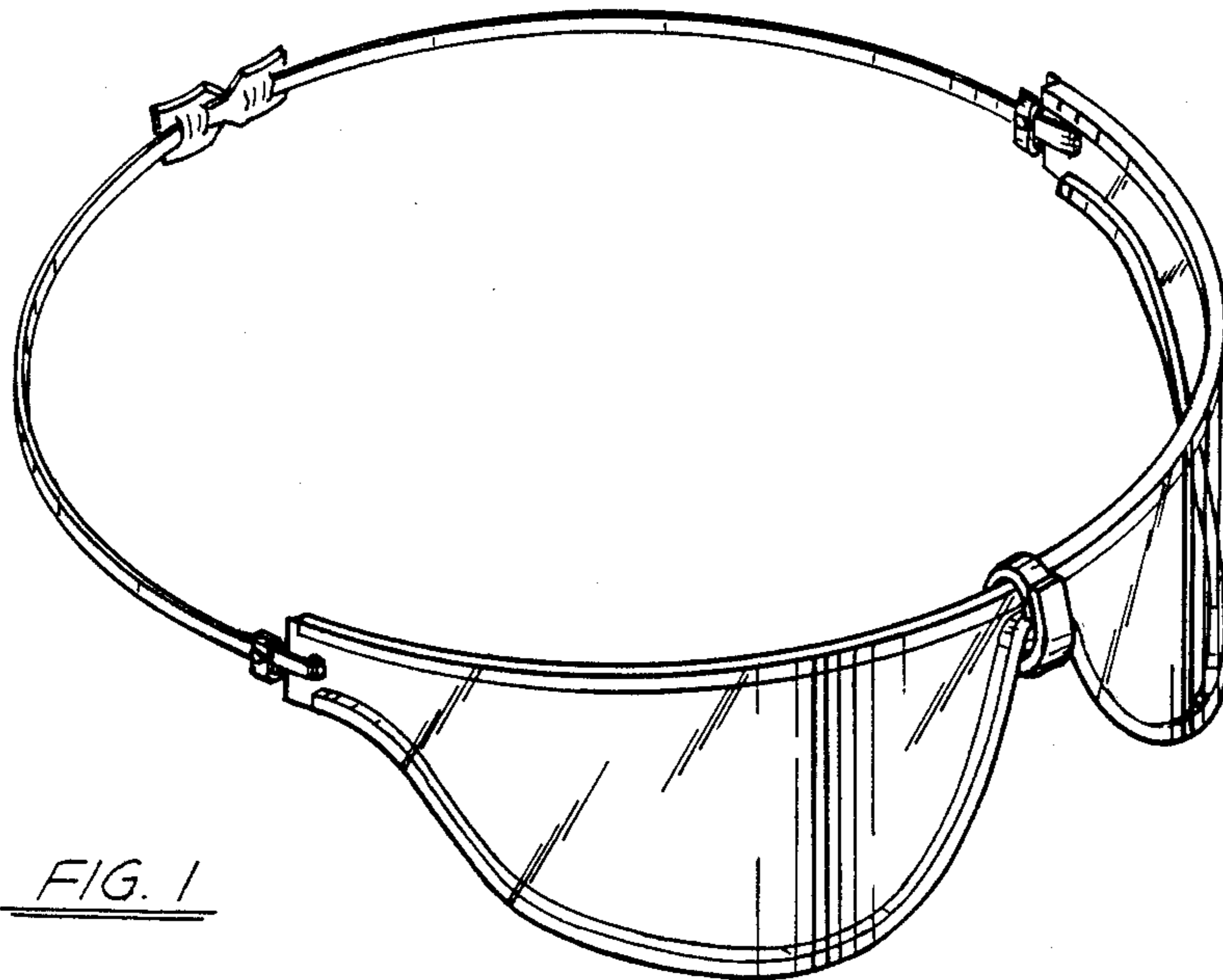

FIG. 1

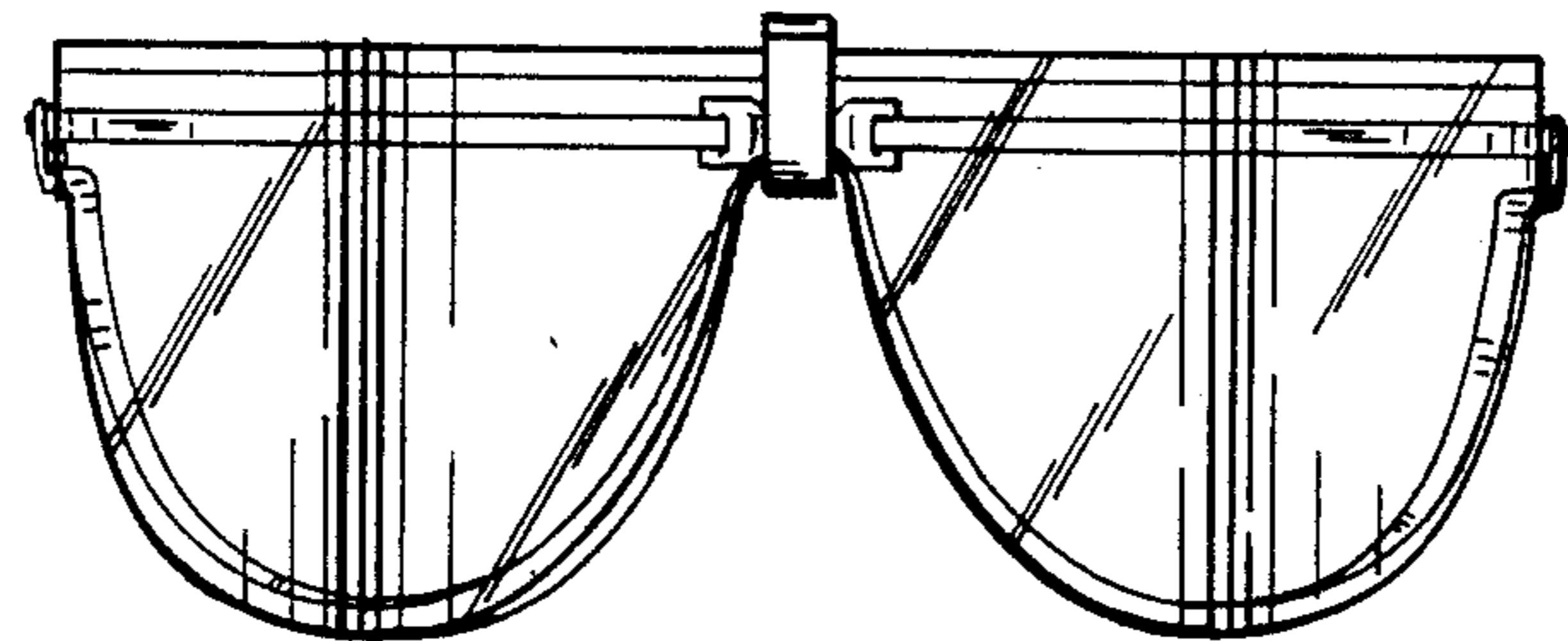

FIG. 2

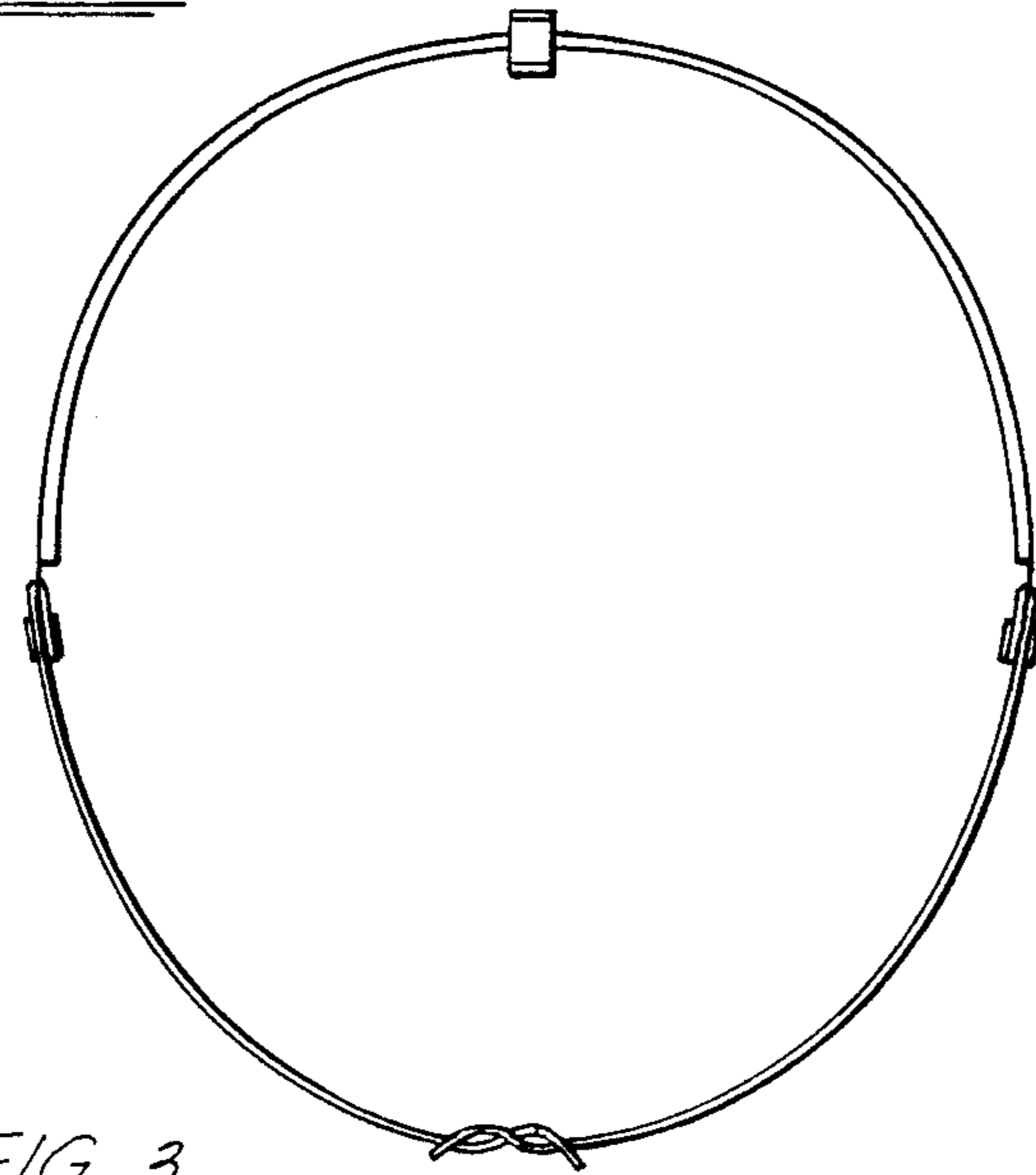

FIG. 3

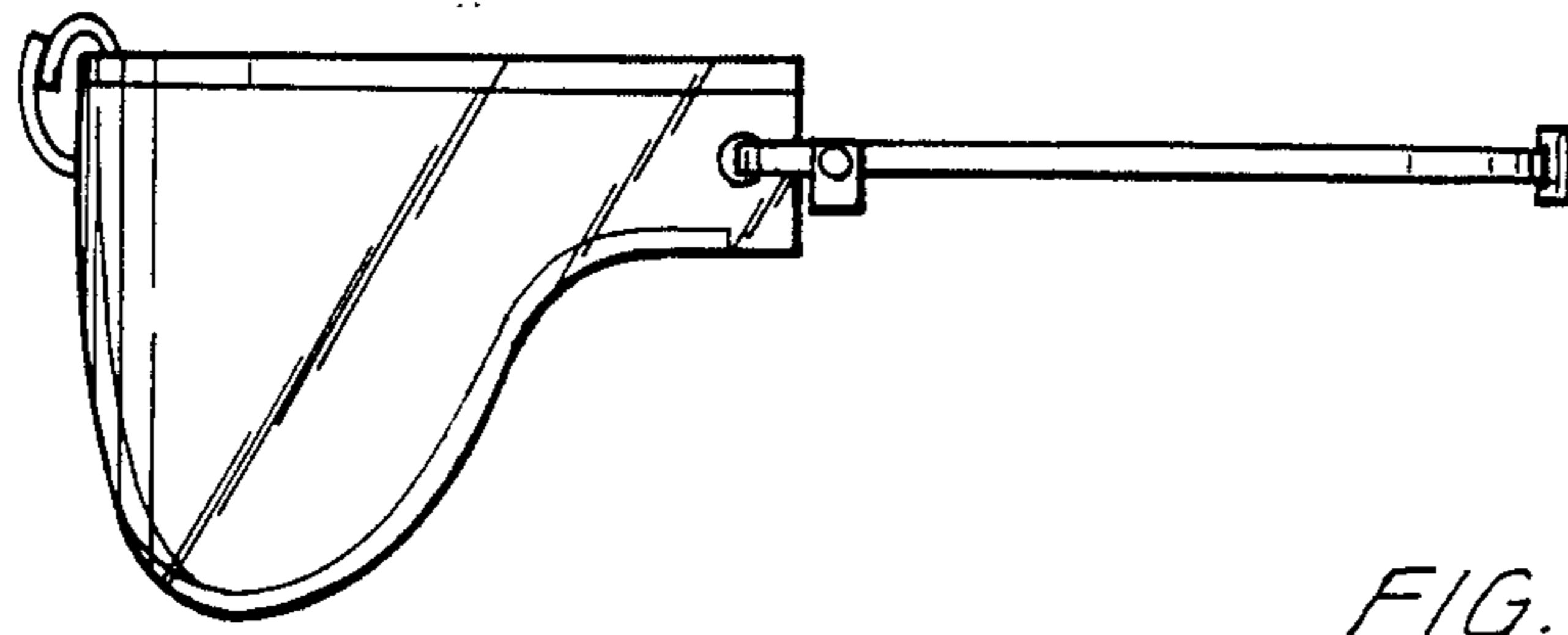

FIG. 4

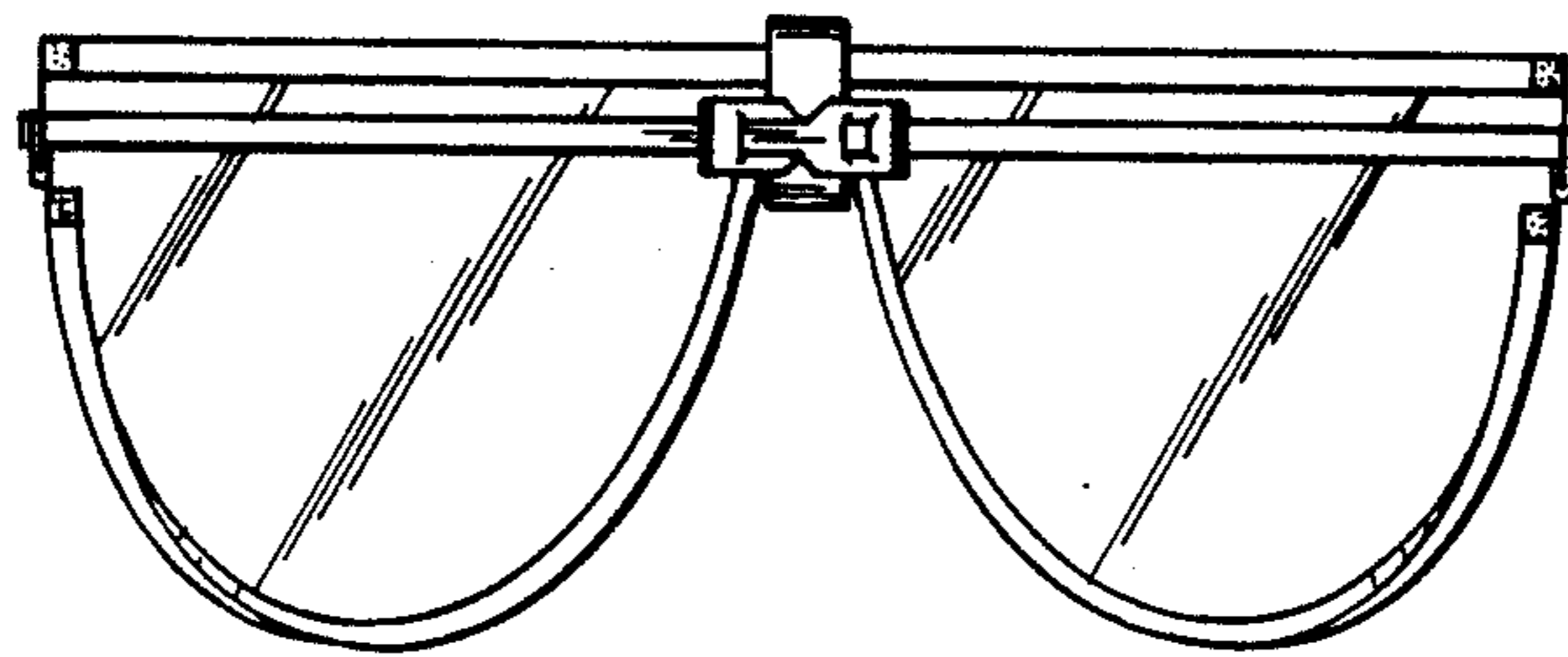

FIG. 5

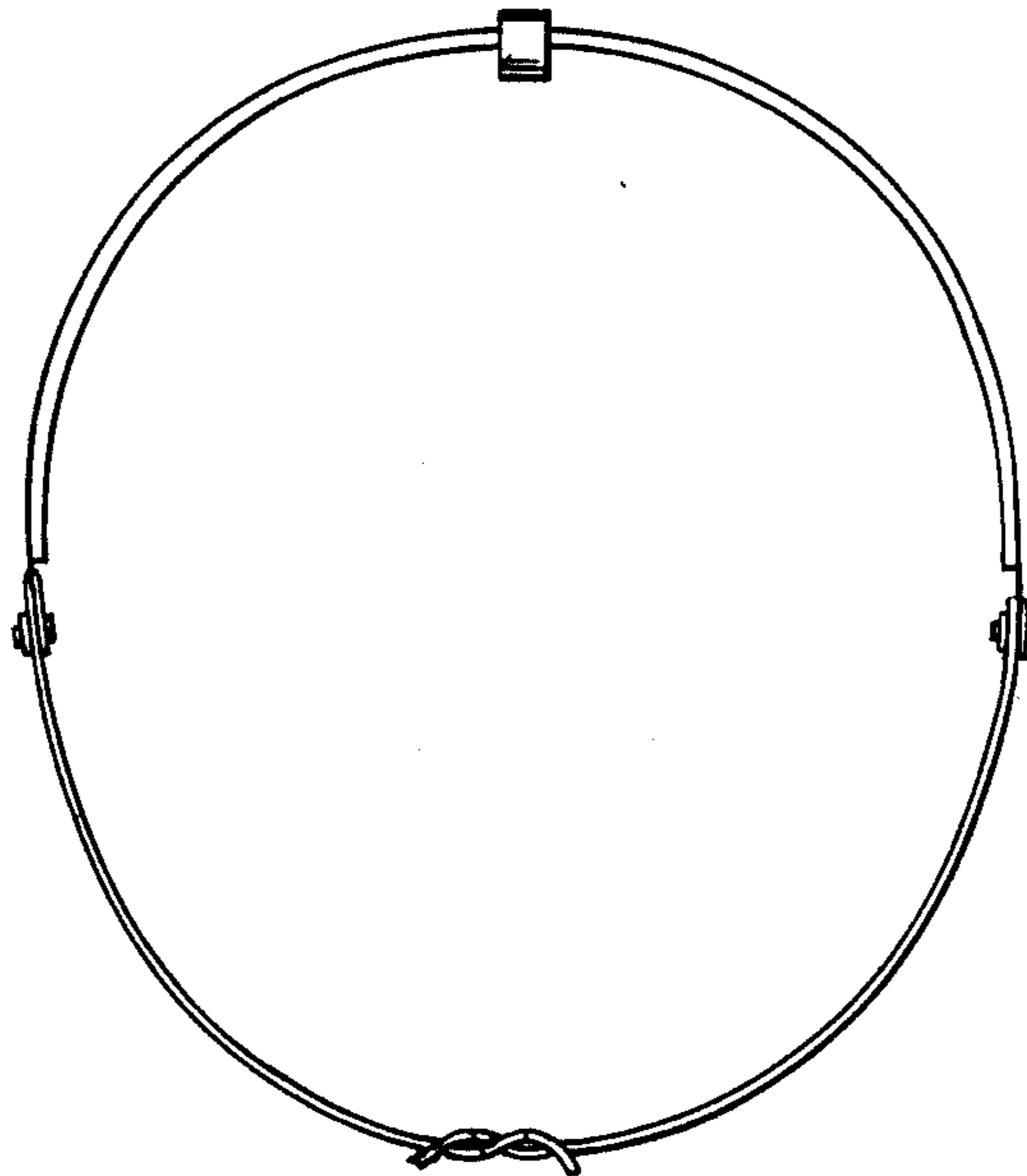

FIG. 6