

[54] TRACTOR FOR LAWNS, GARDENS, OR THE LIKE

3,826,530 7/1974 Hoffmeyer et al. 180/89.1

[75] Inventors: David A. Westimayer, Horicon, Wis.; William E. Crookes, Waldwick, N.J.; Daniel R. Nickles, Monroe, N.Y.

[73] Assignee: Deere & Company, Moline, Ill.

[**] Term: 14 Years

[21] Appl. No.: 176,139

[22] Filed: Mar. 31, 1988

[52] U.S. Cl. D15/15; D15/23

[58] Field of Search D15/14, 15, 16, 17, D15/23; 56/13.4, 16.7, 202, 320.1, 320.2, 255; 180/89.1, 89.12, 900

[56] References Cited

U.S. PATENT DOCUMENTS

- D. 248,397 7/1978 Cognata et al. D15/15
- D. 292,406 10/1987 Kruse et al. D15/23

OTHER PUBLICATIONS

Implement & Tractor, 1/7/64, p. 15, pic. of tractor. Murray Catalogue, "1978 Medalists from Murray", 5/18/78, p. 12, tractor mower (on top).

Primary Examiner—B. J. Bullock
Assistant Examiner—Sandra Morris

[57] CLAIM

The ornamental design for a tractor for lawns, gardens, or the like, as shown and described.

DESCRIPTION

FIG. 1 is a front elevational view of a tractor for lawns, gardens, or the like showing our new design; FIG. 2 is a left side elevational view thereof; FIG. 3 is a bottom plan view thereof; FIG. 4 is a top plan view thereof; FIG. 5 is a right side elevational view thereof; FIG. 6 is a front elevational view; FIG. 7 is a rear elevational view.

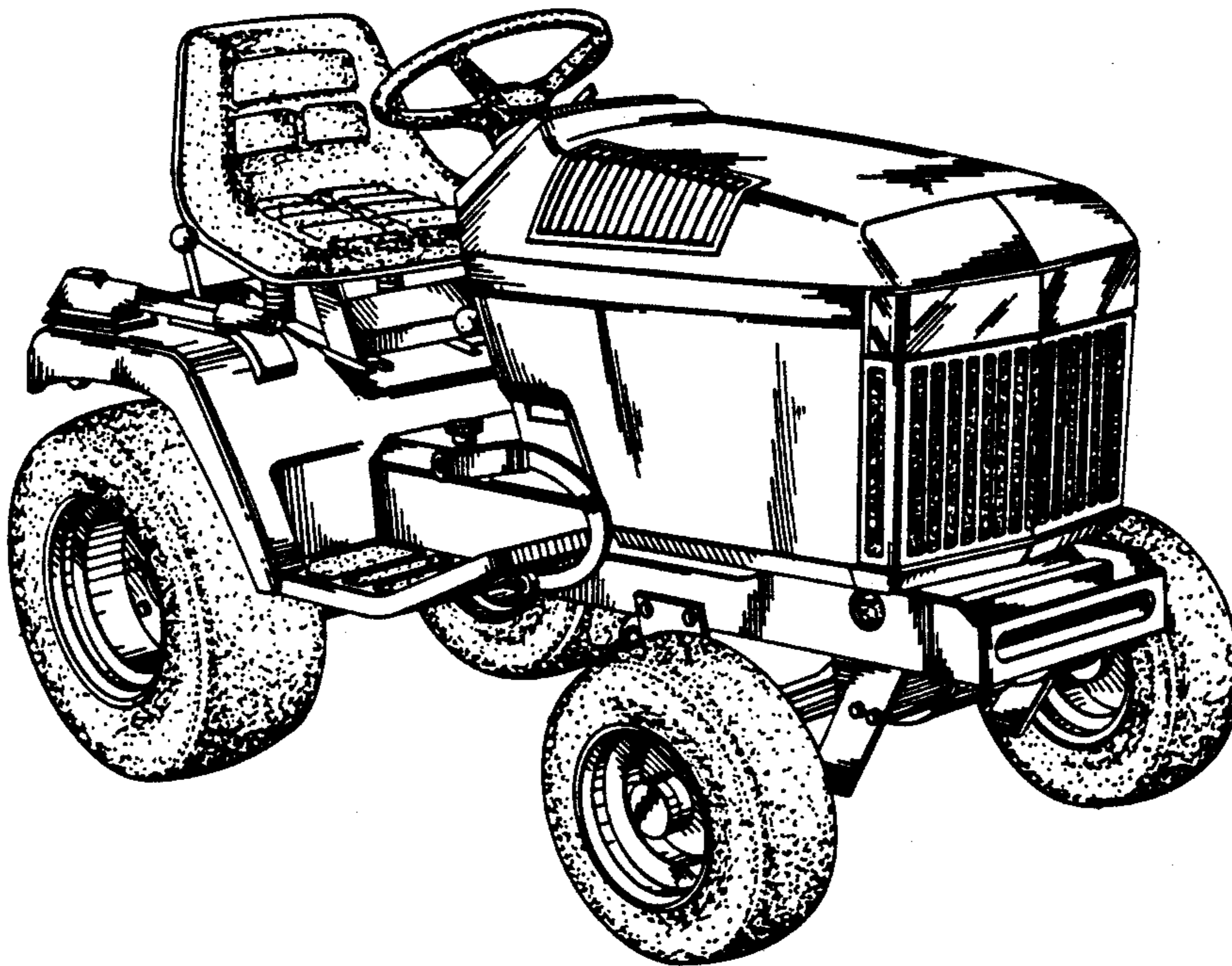

Fig. 1

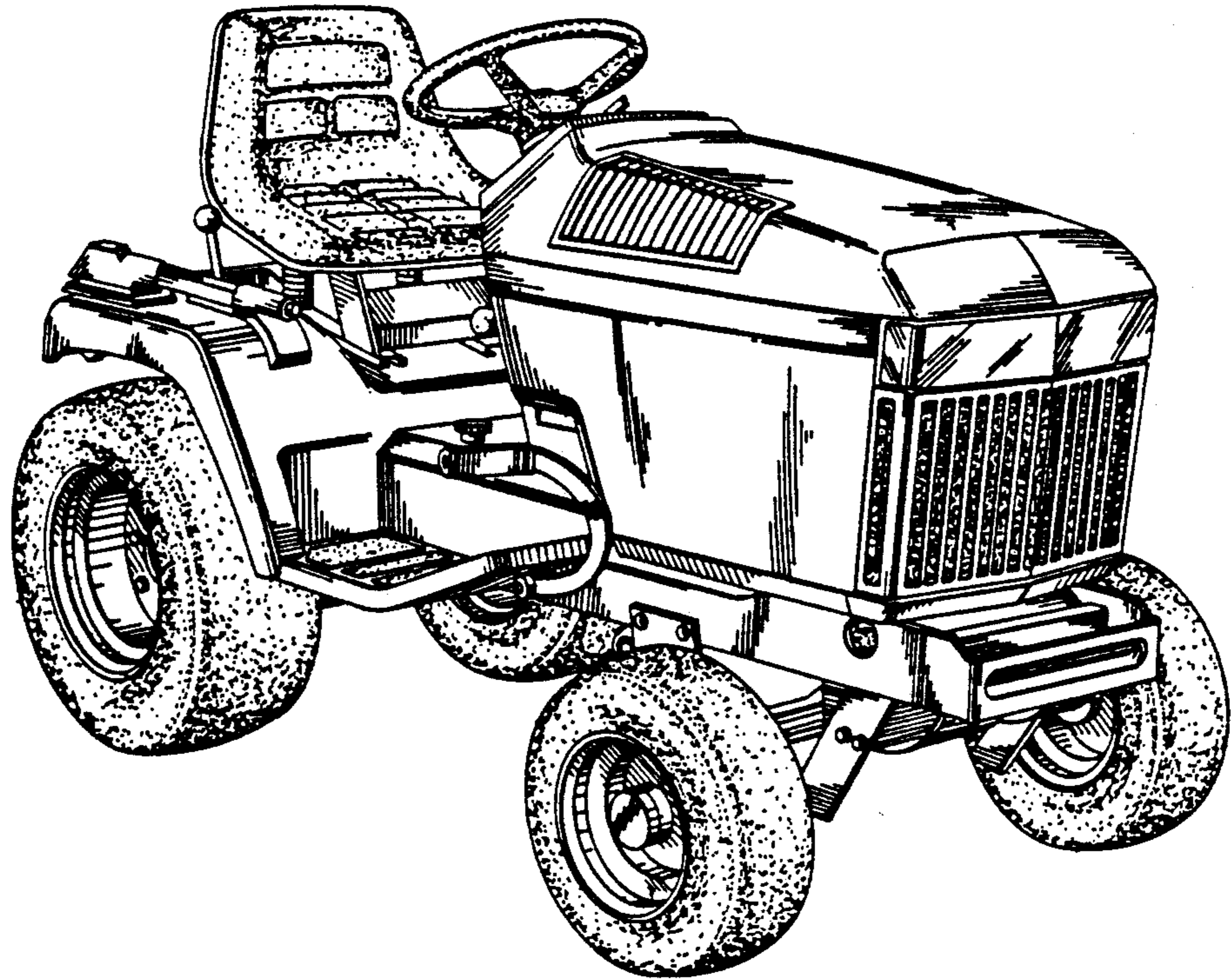

Fig. 2

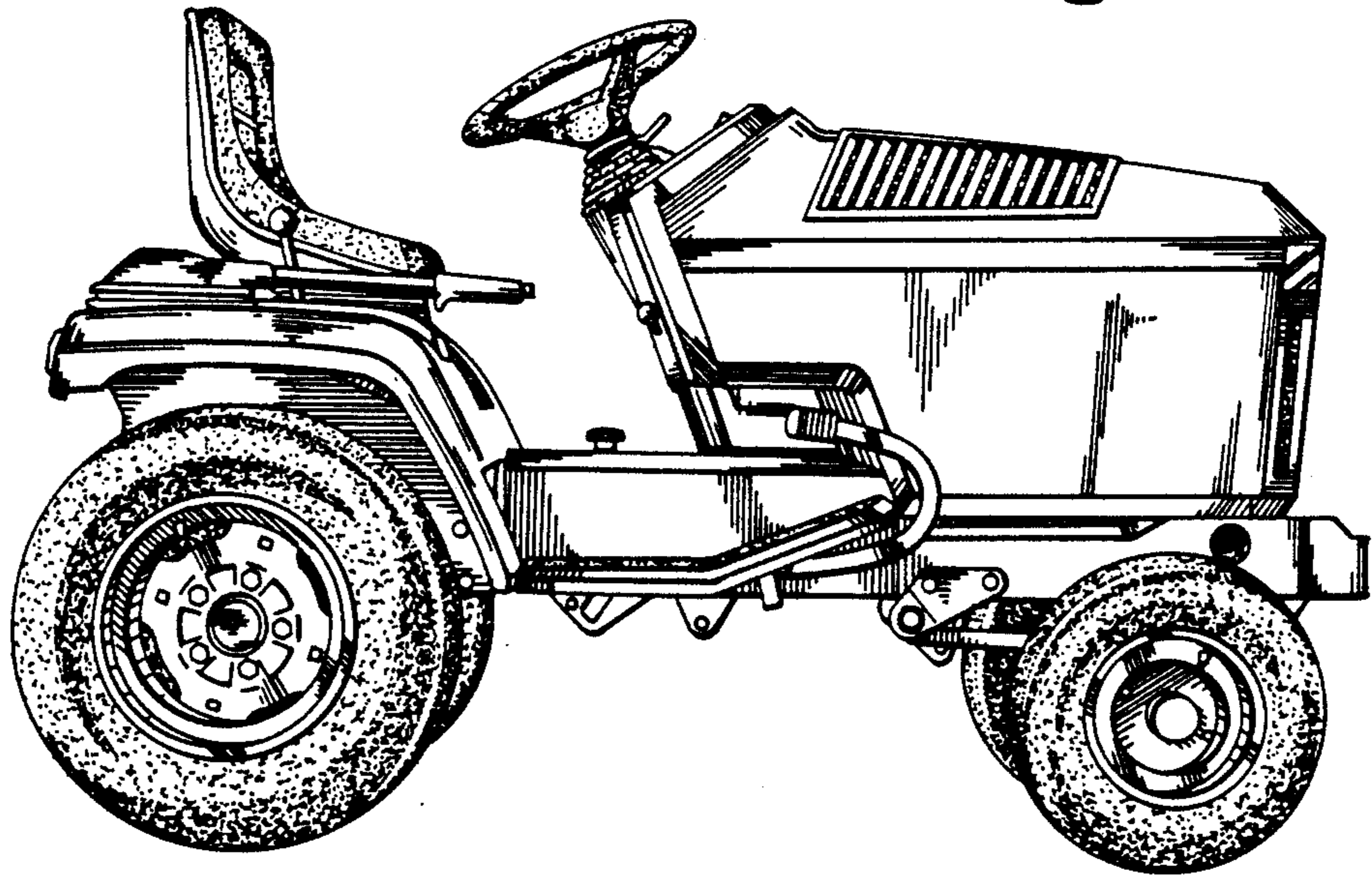

Fig. 3

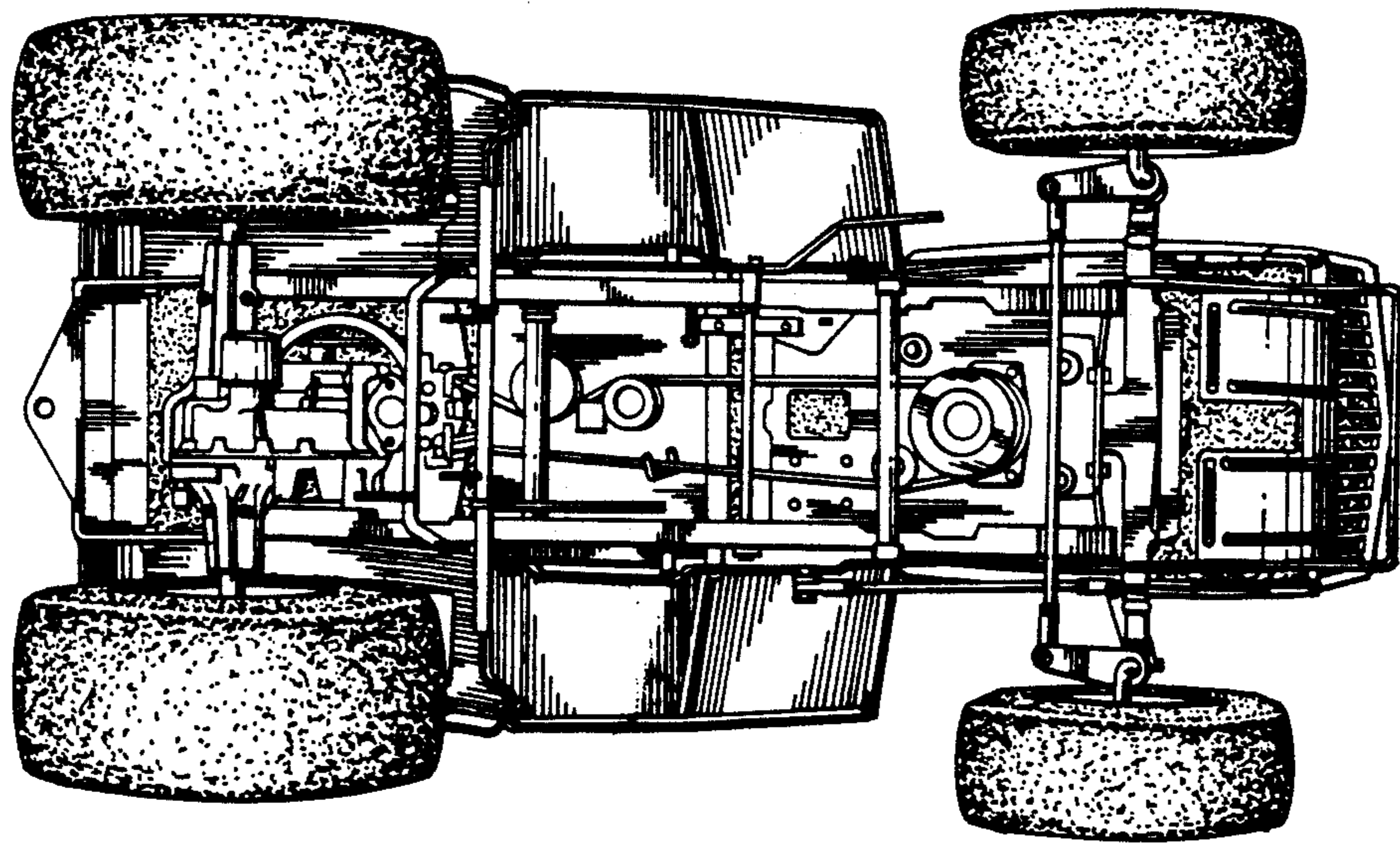

Fig. 4

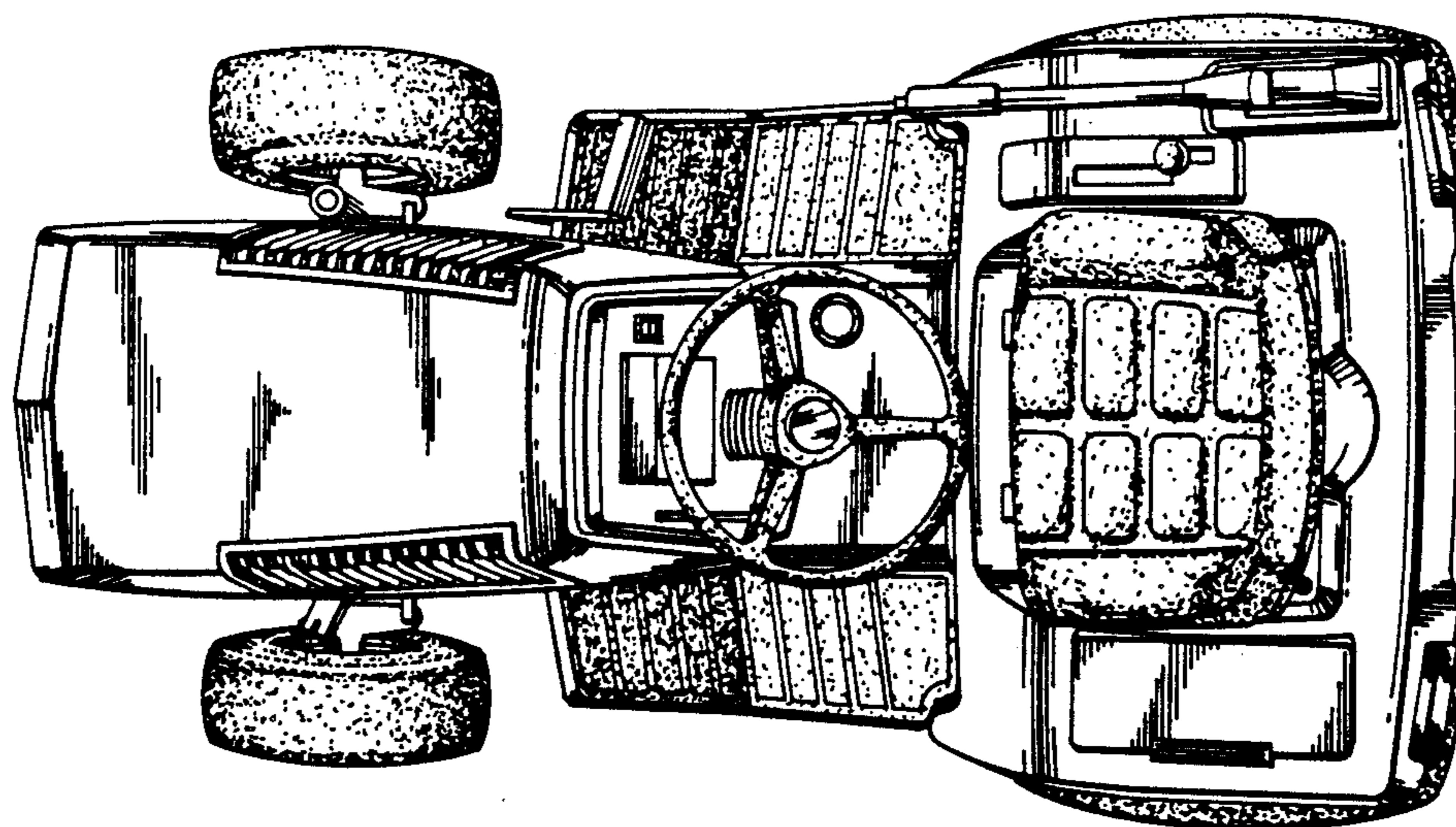

Fig. 5

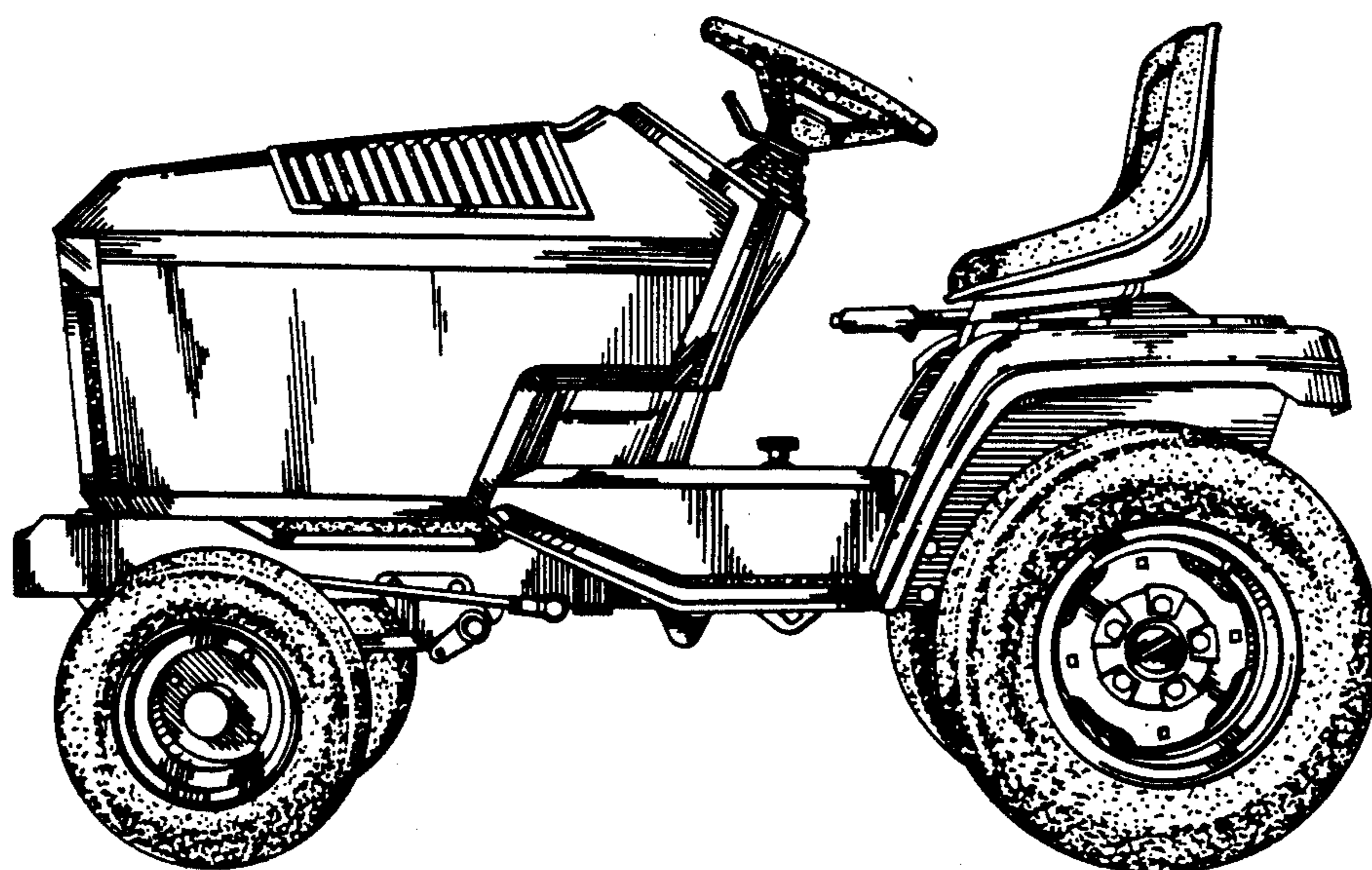

Fig. 6

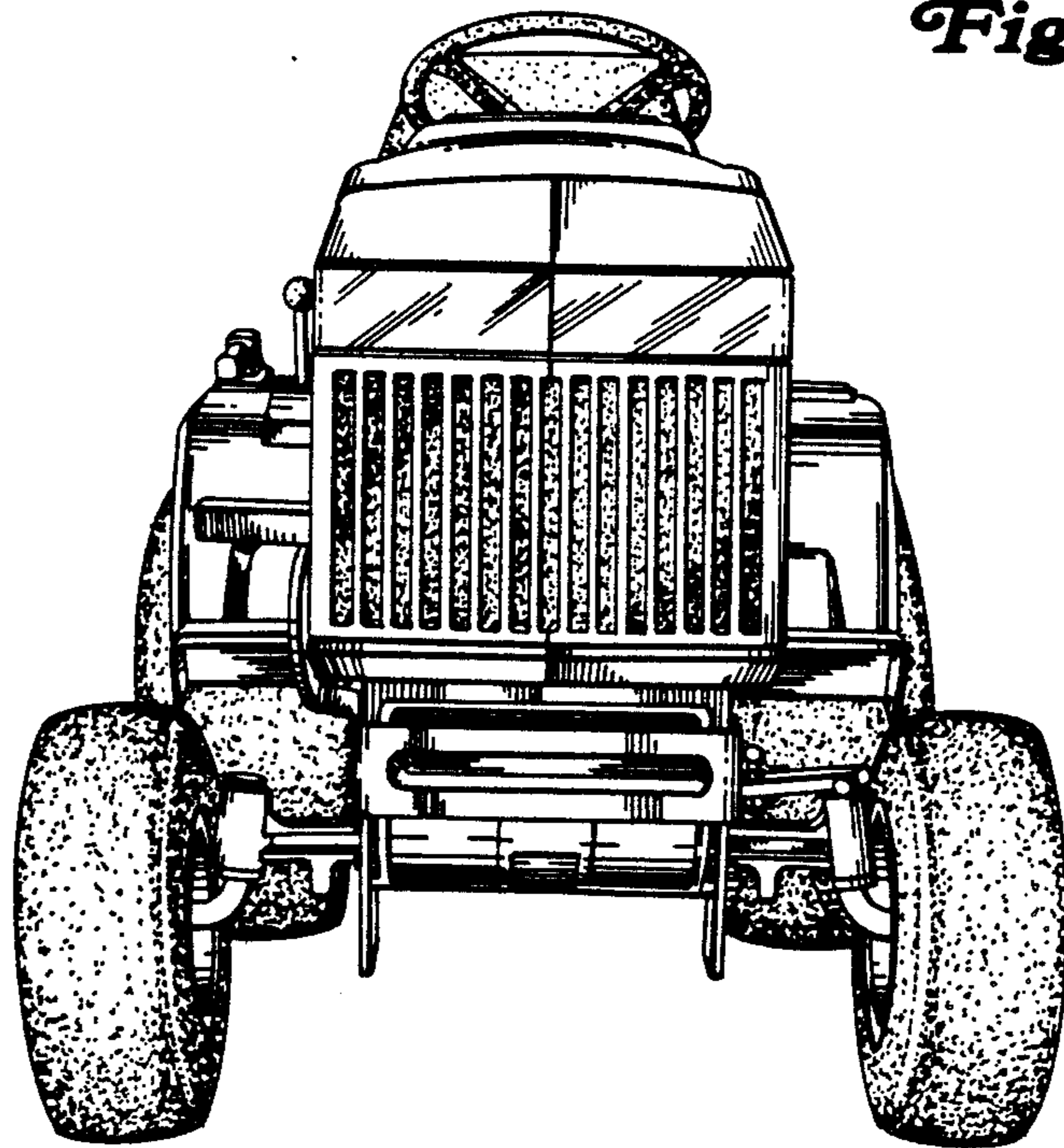

Fig. 7

