

[54] **REMOTE CONTROL ADAPTER**

[76] **Inventor: Devan Dockery, Rte. 8, Box 14, DeFuniak Springs, Fla. 32433**

[**] **Term: 14 Years**

[21] **Appl. No.: 225,941**

[22] **Filed: Jul. 29, 1988**

[52] **U.S. Cl. D14/217; D14/218**

[58] **Field of Search D14/217, 218, 299; 455/151, 352-355, 601-603, 605; 358/194.1**

[56] **References Cited**

U.S. PATENT DOCUMENTS

D. 300,432 3/1989 Zuehsow D14/218

OTHER PUBLICATIONS

Crutchfield Catalog; Summer 1986; p. 99; bottom left--Tyron remote control power booster.

Video Review; Jun. 1987; p. 79; bottom right--Monster Cable remote power booster.

Primary Examiner—Theodore M. Shooman
Attorney, Agent, or Firm—Gifford, Groh, Sprinkle, Patmore and Anderson

[57] **CLAIM**

The ornamental design for a remote control adapter, as shown and described.

DESCRIPTION

FIG. 1 is a top front and right side perspective view of a remote control adapter showing my new design; FIG. 2 is a front elevational view thereof; FIG. 3 is a right side elevational view thereof, the left side being a mirror image; FIG. 4 is a rear elevational view thereof; FIG. 5 is a top plan view thereof; and FIG. 6 is a bottom plan view thereof. The broken line showing the remote control in FIG. 1 is for illustrative purposes only and forms no part of the claimed design.

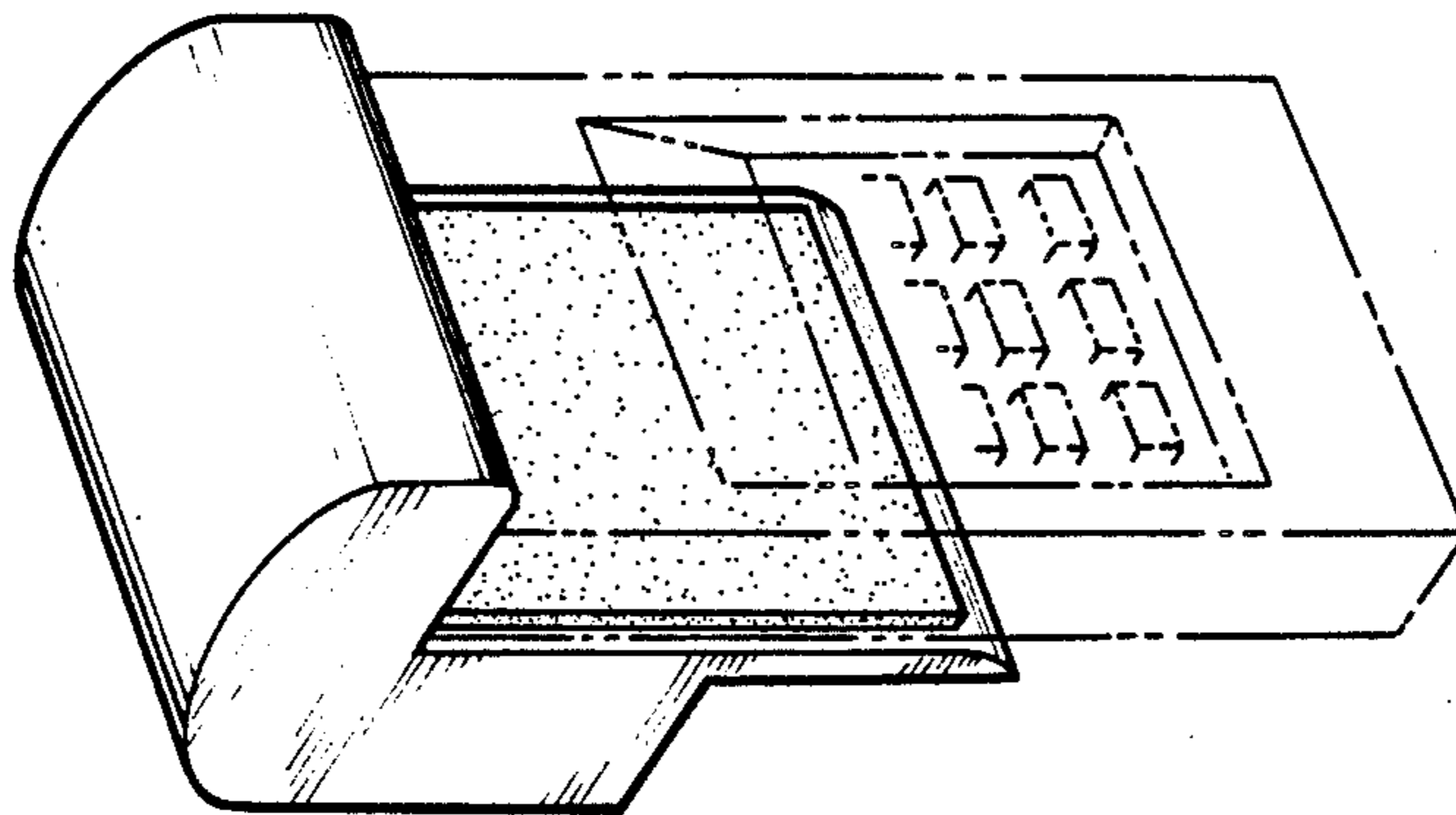

Fig-1

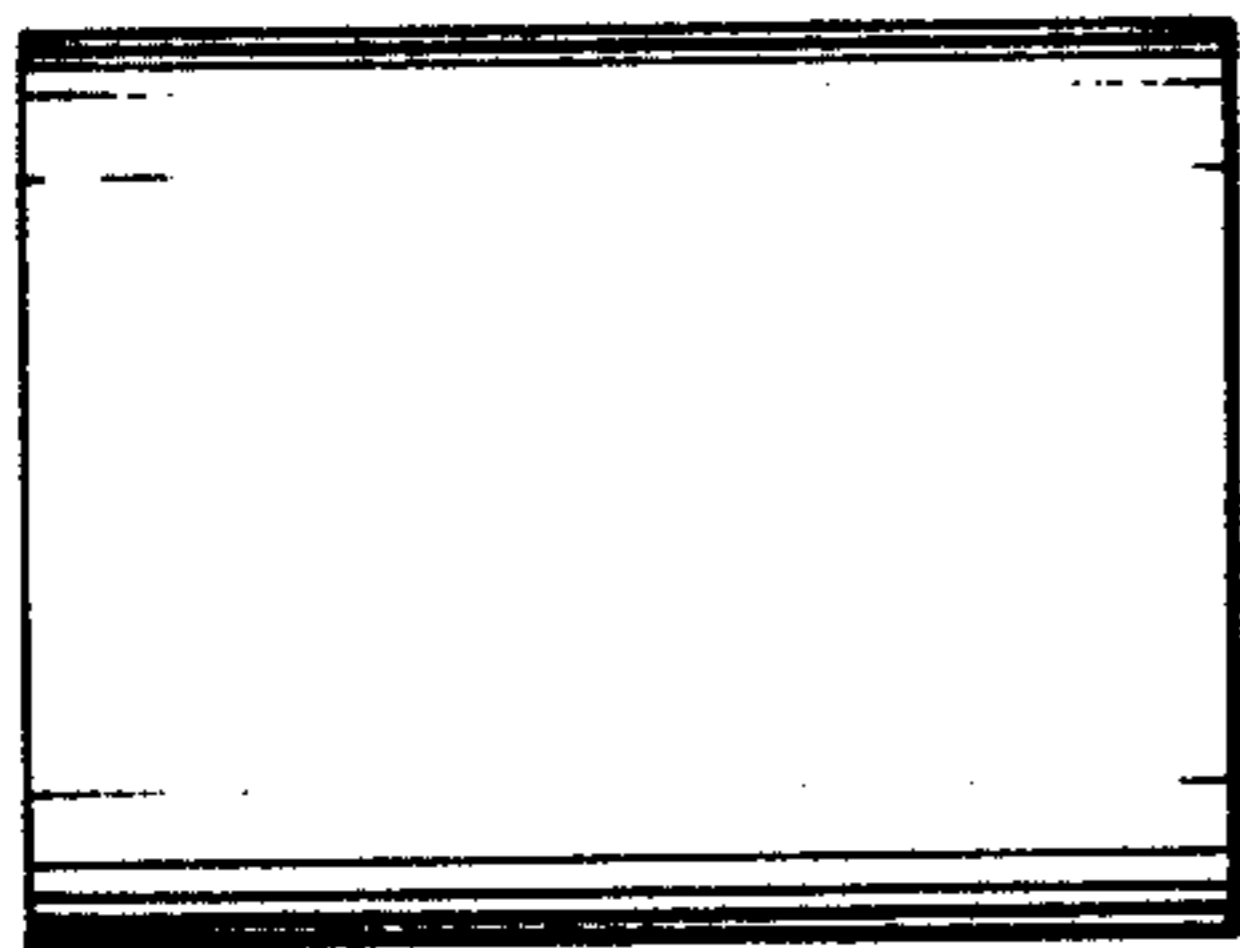
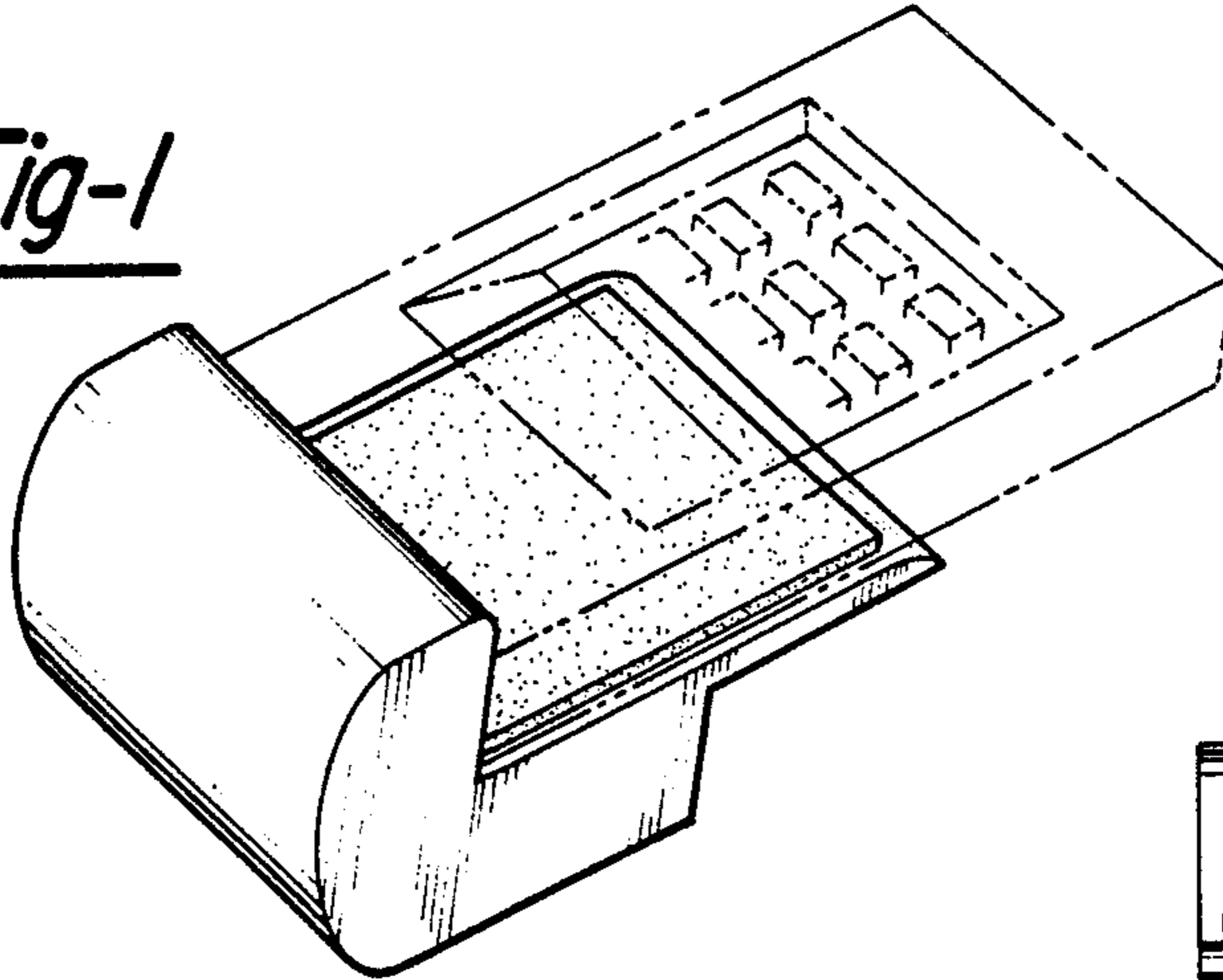

Fig-2

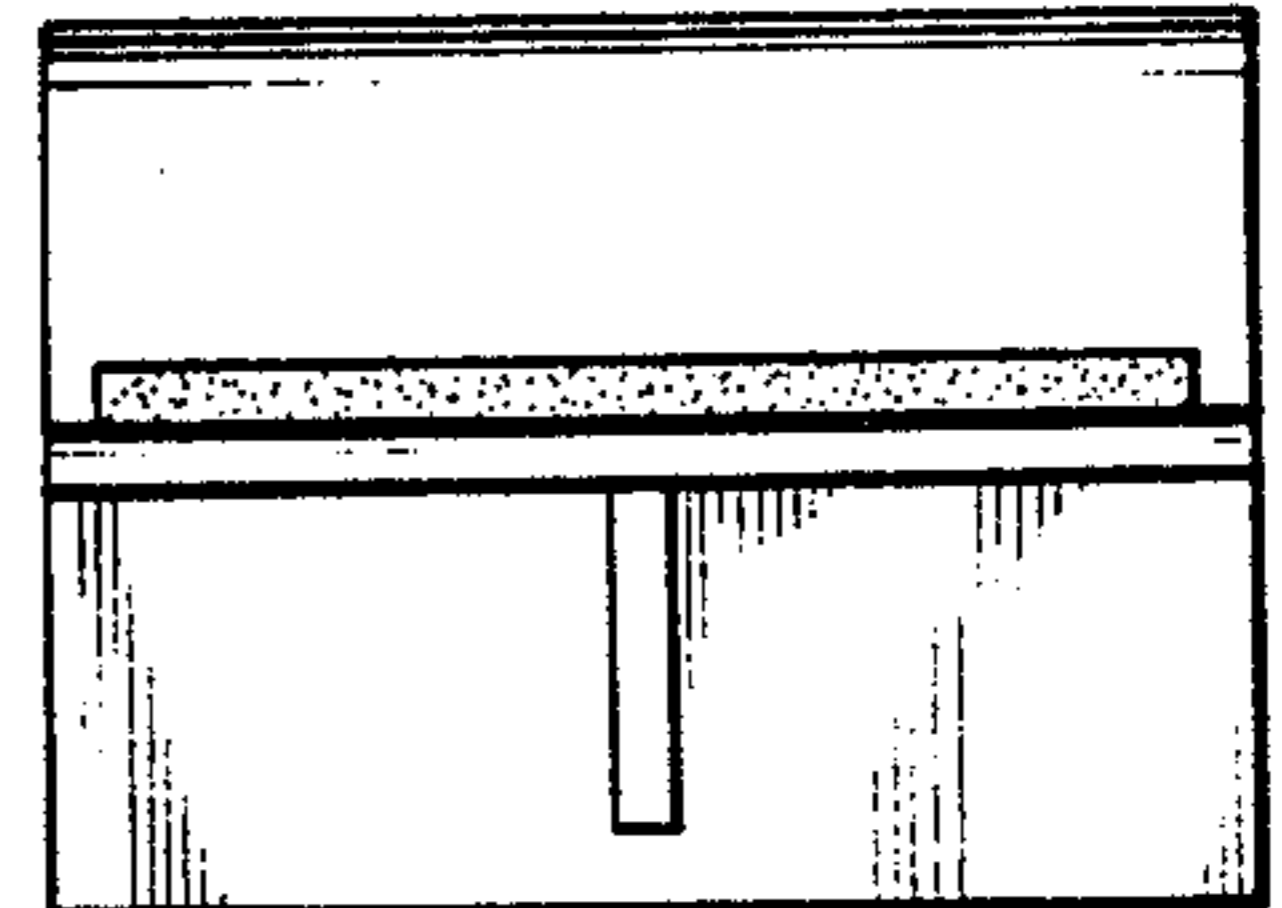

Fig-4

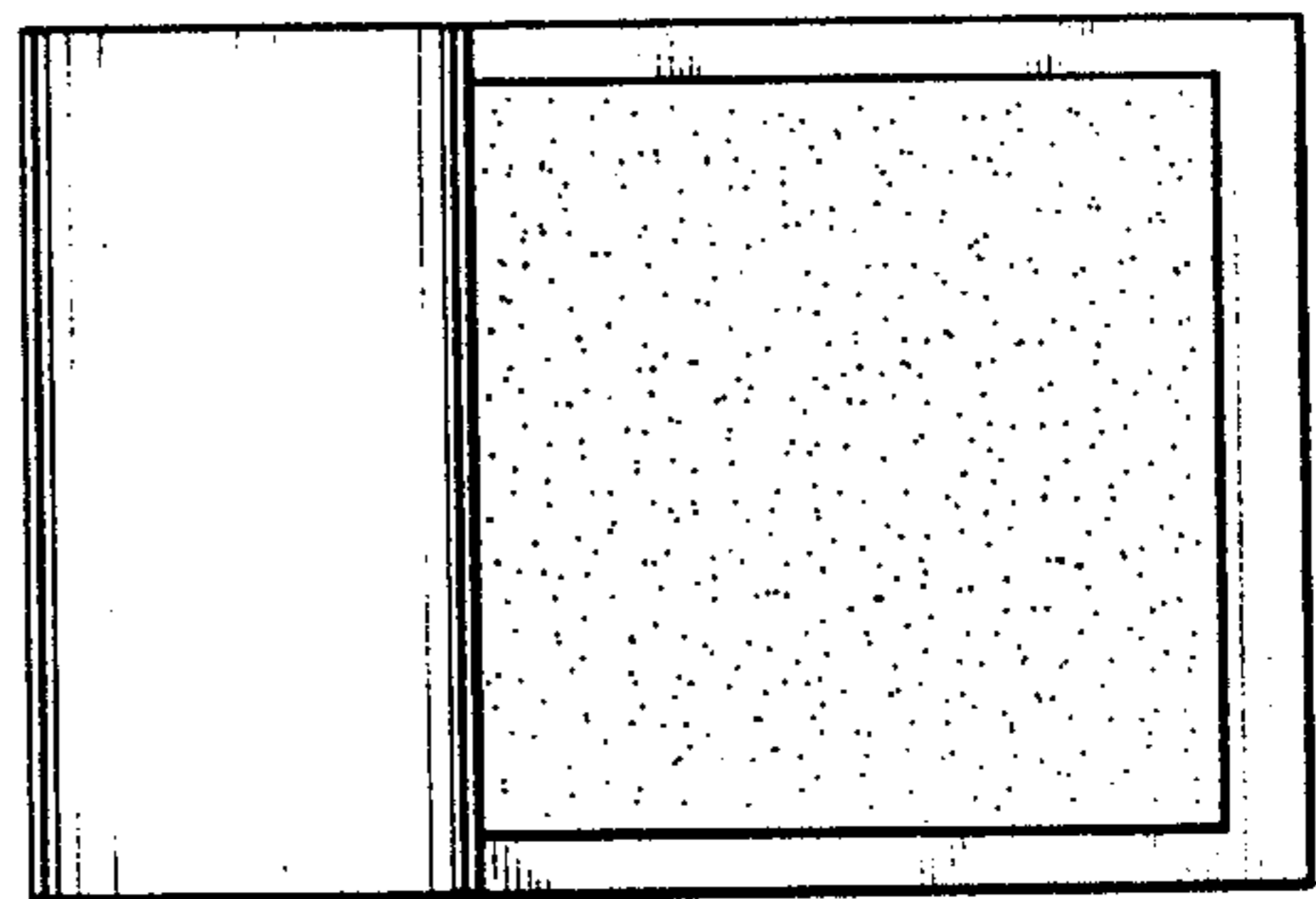

Fig-5

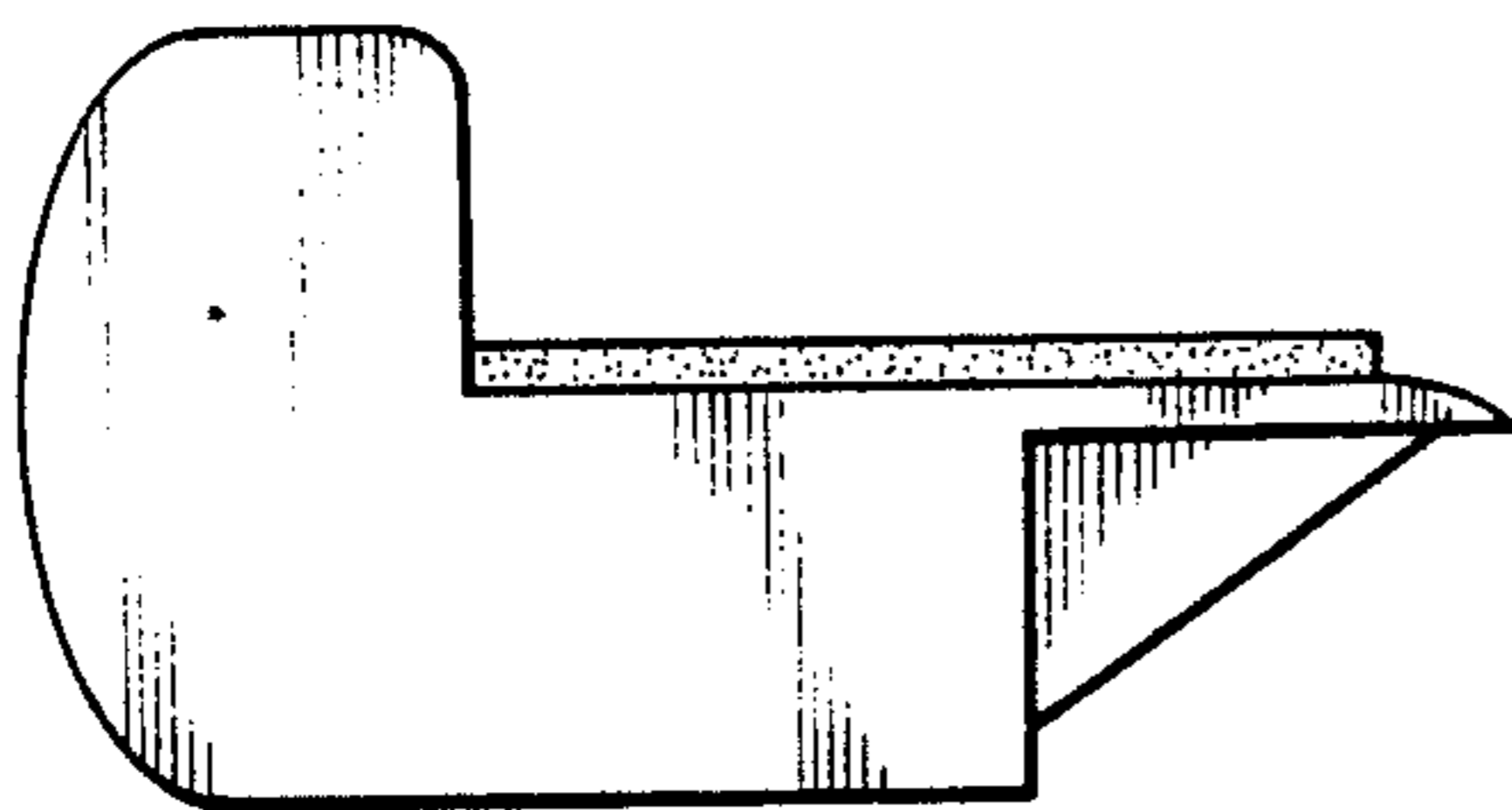

Fig-3

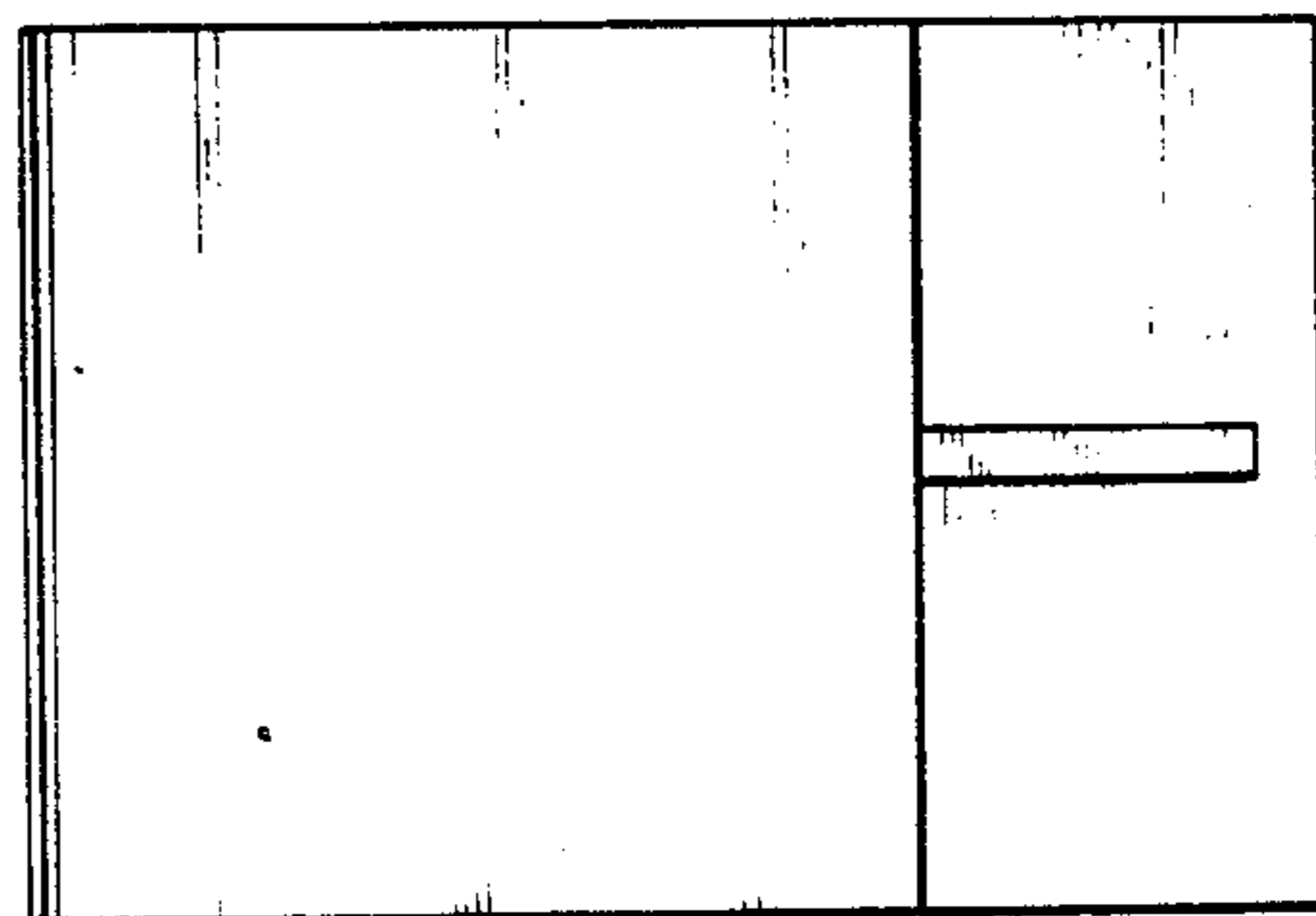

Fig-6