

[54] **ELECTRONIC COMPUTER** 4,730,364 3/1988 Tat-Kee 364/708
 4,742,478 5/1988 Nigro, Jr. et al. 361/394 X

[75] **Inventors: Yoshihiko Sugano; Masahiko Tabuchi, both of Tokyo, Japan**

[73] **Assignee: Kabushiki Kaisha Toshiba, Kanagawa, Japan**

[**] **Term: 14 Years**

[21] **Appl. No.: 131,388**

[22] **Filed: Dec. 10, 1987**

[30] **Foreign Application Priority Data**
 Jun. 17, 1987 [JP] Japan 62-24428

[52] **U.S. Cl. D14/106**

[58] **Field of Search D14/100, 102, 105, 106, D14/107, 113, 115; D18/1, 7, 11, 12; 235/145 A, 145 R; 340/700, 706, 711, 712; 341/22, 23; 358/249, 254; 364/706-710; 400/472, 479, 486, 489; 312/198, 208**

FOREIGN PATENT DOCUMENTS

47-14961 5/1972 Japan .
 499866 4/1979 Japan .
 599666 4/1983 Japan .
 650470 5/1985 Japan .
 664175 10/1985 Japan .
 85300416 5/1986 Japan .
 684172 8/1986 Japan .
 684172 8/1986 Japan .
 685000 8/1986 Japan .
 685000 8/1986 Japan .
 685063 8/1986 Japan .
 685121 8/1986 Japan .
 685733 8/1986 Japan .
 686374 9/1986 Japan .
 686381 9/1986 Japan .
 686386 9/1986 Japan .
 686706 9/1986 Japan .
 695931 12/1986 Japan .
 696188 1/1987 Japan .
 697328 1/1987 Japan .
 685121 10/1988 Japan .
 67297 2/1987 Rep. of Korea .
 85-2546 1/1987 Sweden .
 85-2547 1/1987 Sweden .

[56] **References Cited**

U.S. PATENT DOCUMENTS

221,002 6/1971 Bachman .
 222,472 10/1971 Jacobson .
 224,784 7/1972 Sucre et al. .
 247,563 3/1978 Jinbo et al. .
 D. 254,005 1/1980 Zadock et al. .
 D. 258,957 4/1981 Bevilacqua et al. .
 D. 275,102 8/1984 MacConnel .
 D. 280,511 9/1985 Moggridge et al. .
 D. 282,843 3/1986 Kurihara et al. .
 D. 283,511 4/1986 Dunn .
 D. 284,193 6/1986 Marshall .
 D. 284,474 7/1986 Sawada .
 D. 287,969 1/1987 Kusanagi .
 D. 288,566 3/1987 Chin et al. .
 D. 289,177 4/1987 Sawada .
 D. 289,763 5/1987 Fujii et al. .
 D. 290,256 6/1987 Sapper et al. .
 D. 290,845 7/1987 Yubisui et al. .
 D. 291,442 8/1987 Kurihara .
 D. 293,677 1/1988 Hara et al. .
 D. 293,678 1/1988 Sawatani et al. .
 D. 294,029 2/1988 Nishiyama et al. .
 D. 294,831 3/1988 Hara et al. .
 D. 295,176 4/1988 Nishimoto et al. .
 4,497,036 1/1985 Dunn 364/708

OTHER PUBLICATIONS

Sharp "Character Display" Article, 5/18/76.
 Fanuc System P-Model, 07/27/83.
 Moebel Interior Design, 01/05/84.
 Micro Office Systems "Road Runner", 01/31/84.
 Demus 645, 02/22/84.
 Design 423, 05/08/84.
 Epson HC-88, 07/01/84.
 Dulmont Model Magnum, 08/00/84.
 Apple Computer, 10/15/84.
 Texas Instruments Pro-Lite, 11/14/84.
 Tandy 200, 00/00/85.
 General Corporation 4400, 01/14/85.
 Drawing J60007802, 02/26/85.
 Aval TM 20, 03/08/85.
 C & D News, 03/29/85.
 Hewlett-Packard HP110, 04/00/85.
 Sharp PC5000, 04/00/85.
 Fujitsu FM 16, 04/17/85.

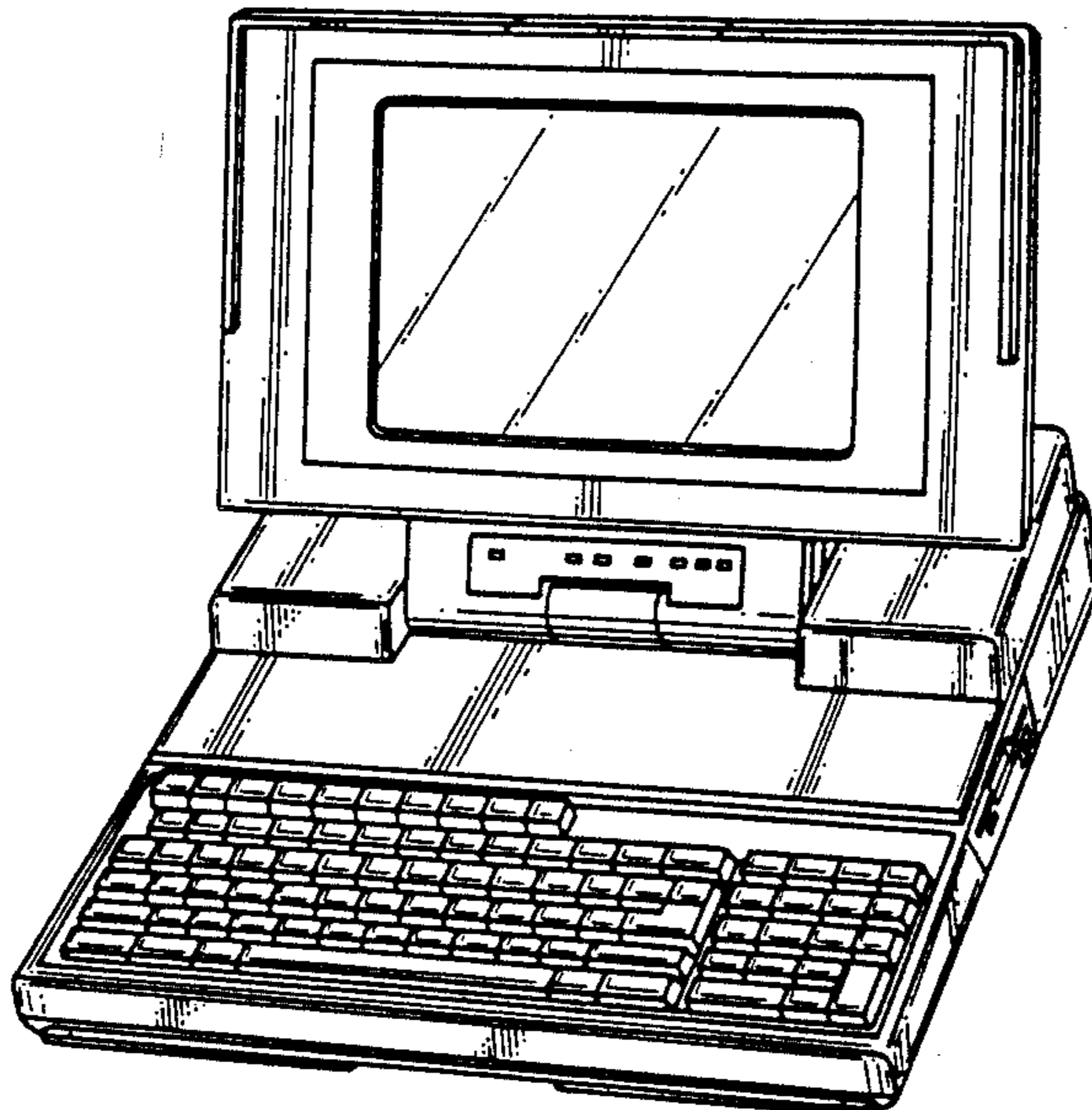

Data General One Advertisement, 05/23/85.
Toshiba T1100 Plus, 07/22/85.
Minato Electronics MODS-5000, 08/22/85.
Hewlett-Packard Portable Plus, 12/00/85.
Apple IIC, 12/00/85.
Fuji Line Motor Monitor FLM 700, 01/31/86.
MRD Advertisement, 03/29/84.
Gavilan Mobile Computer Brochure, 04/19/84.
Hewlett-Packard Advertisement, 06/05/84.
Hitachi Advertisement, 09/04/84.
Hewlett-Packard Advertisement, 09/12/84.
Sharp PC-5000 Brochure, 09/26/84.
Data General One Advertisement, 09/28/84.
TI Software Journal, Pro Lite TM, 11/14/84.
IS-11c Advertisement, 11/14/84.
Dulmont Magnum Article in Portable Computer, 11/00/84.
IBM Advertisement, 12/06/84.
AVAL TM Advertisement, 02/11/85.
NEC Starlet PC-8401A Brochure, 03/28/85.
Fujitsu FM16 TL Brochure, 05/22/85.
Data General One Brochure, 05/23/85.
FBS Advertisement, 10/30/85.
IBM Advertisement, 11/28/85.
PC-816F Advertisement, 05/27/86.
Zenith Data Systems NEWSDATE Newsletter, 06/07/86.
Tandy 600 Advertisement, 07/25/86.
Ricoh JP70D Brochure, 09/29/86.
Data General One Brochure, 10/03/86.
Article re IBM Portable Personal Computer, 10/15/86.
NEC PC-98LT Advertisement, 10/23/86.
Yaskawa P-T50 Advertisement, 11/12/86.
Yaskawa Memocon®-SC GL20 Advertisement, 03/27/87.
TI Advertisement in Telephony, 04/01/87.
Data General One Model 2J Brochure, 05/20/87.
Ricoh Mr. Mytool LX Advertisement, 07/31/87.
Visual Computer Brochure.

Gavilan Mobile Computer Brochure.
Olivetti Personal Computer M15 Brochure.
Epson HC-88, HC80 Brochure.
Epson PX-8 Personal Computer Brochure.
Mitsubishi mp286L Laptop Personal Computer Brochure.
Grid Brochure.
Dauphin Laptop Computer Brochure.
MicroDIRECT Brochure.
SupersPort Brochure.
Panasonic KX-D4930 advertisement.
Ampere WS-1 advertisement.
Tandy 200 advertisement.
NEC Starlet PC-8401A advertisement.
Schneider, Multivision 300SLC Catalog.
Victor Technologies, V 286 P Catalog.
GRID Computer Catalogue, dated Sep. 24, 1985.
Fujitsu Computer Catalog, dated Nov. 1984.
Hewlett-Packard Computer advertisement, dated May 18, 1984.

Primary Examiner—Susan J. Lucas
Assistant Examiner—Freda S. Nunn
Attorney, Agent, or Firm—Banner, Birch, McKie & Beckett

[57]

CLAIM

The ornamental design for an electronic computer, as shown and described.

DESCRIPTION

FIG. 1 is a top, front, right side perspective view of an electronic computer showing our new design;
FIG. 2 is a top plan view thereof,
FIG. 3 is a left side elevational view thereof,
FIG. 4 is a rear elevational view thereof,
FIG. 5 is a bottom plan view thereof,
FIG. 6 is a top plan view thereof, the display panel in closed position;
FIG. 7 is an elevational view thereof, the display panel in closed position.

FIG. 1

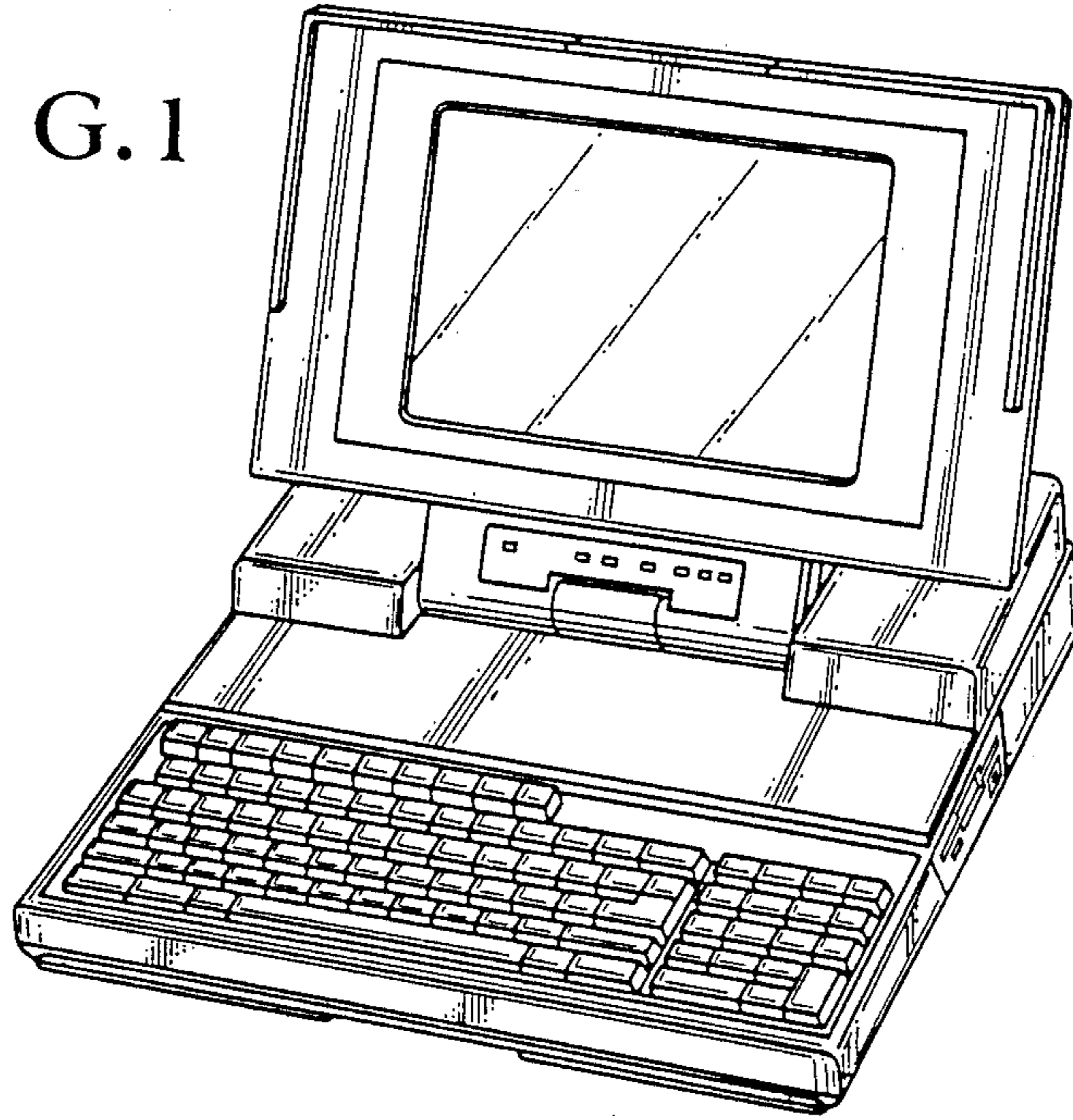
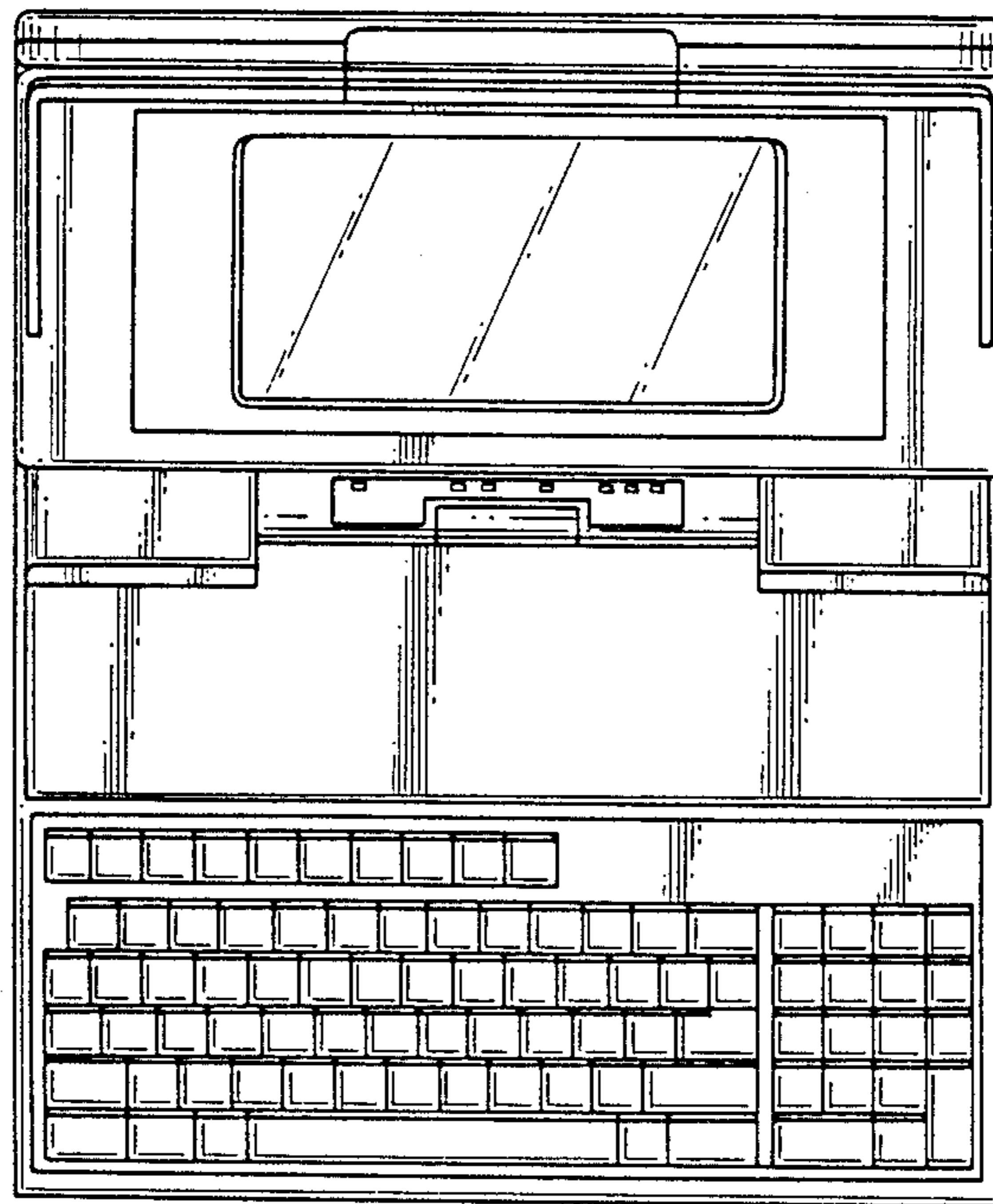

FIG. 2



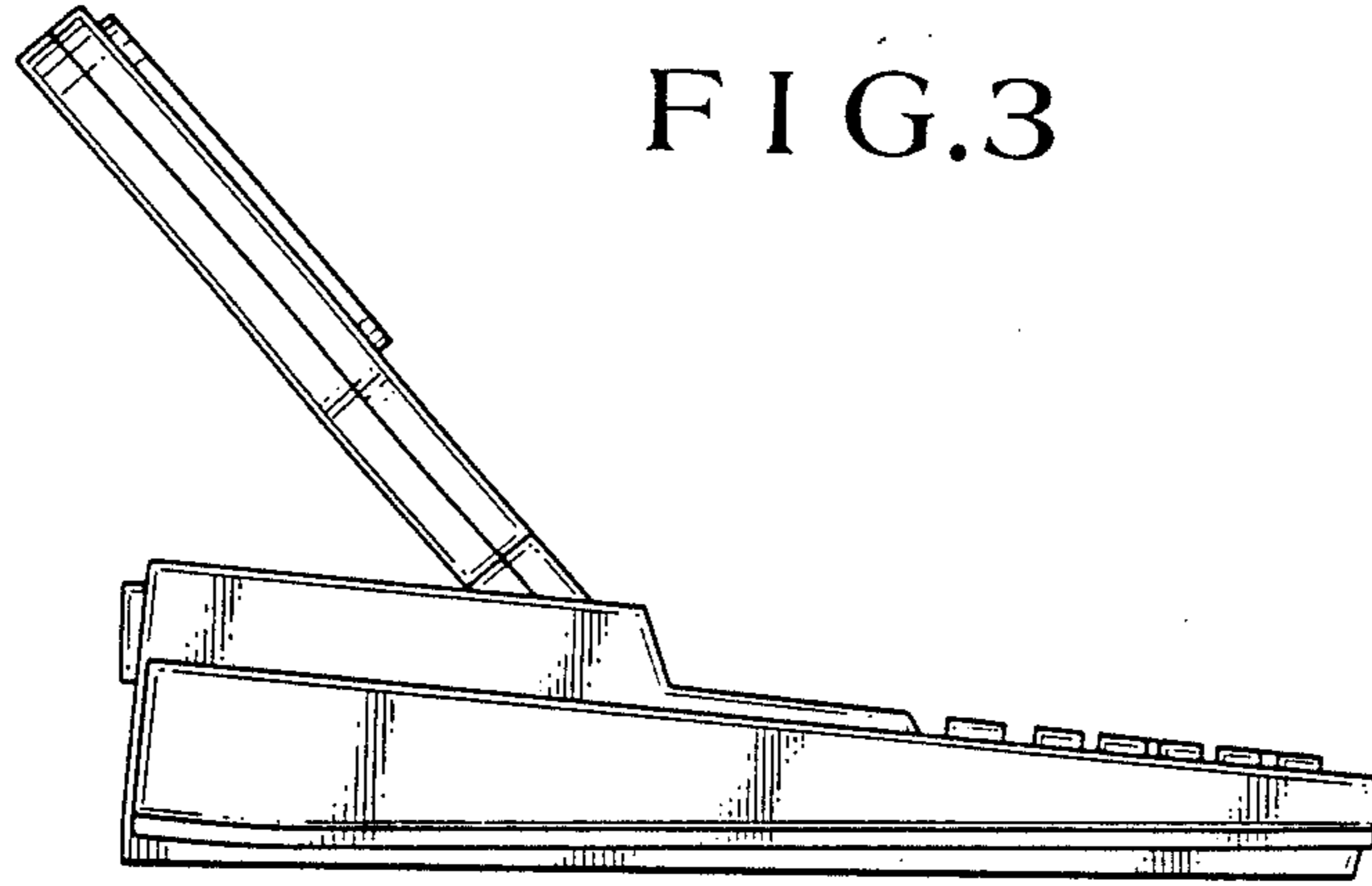

FIG. 4

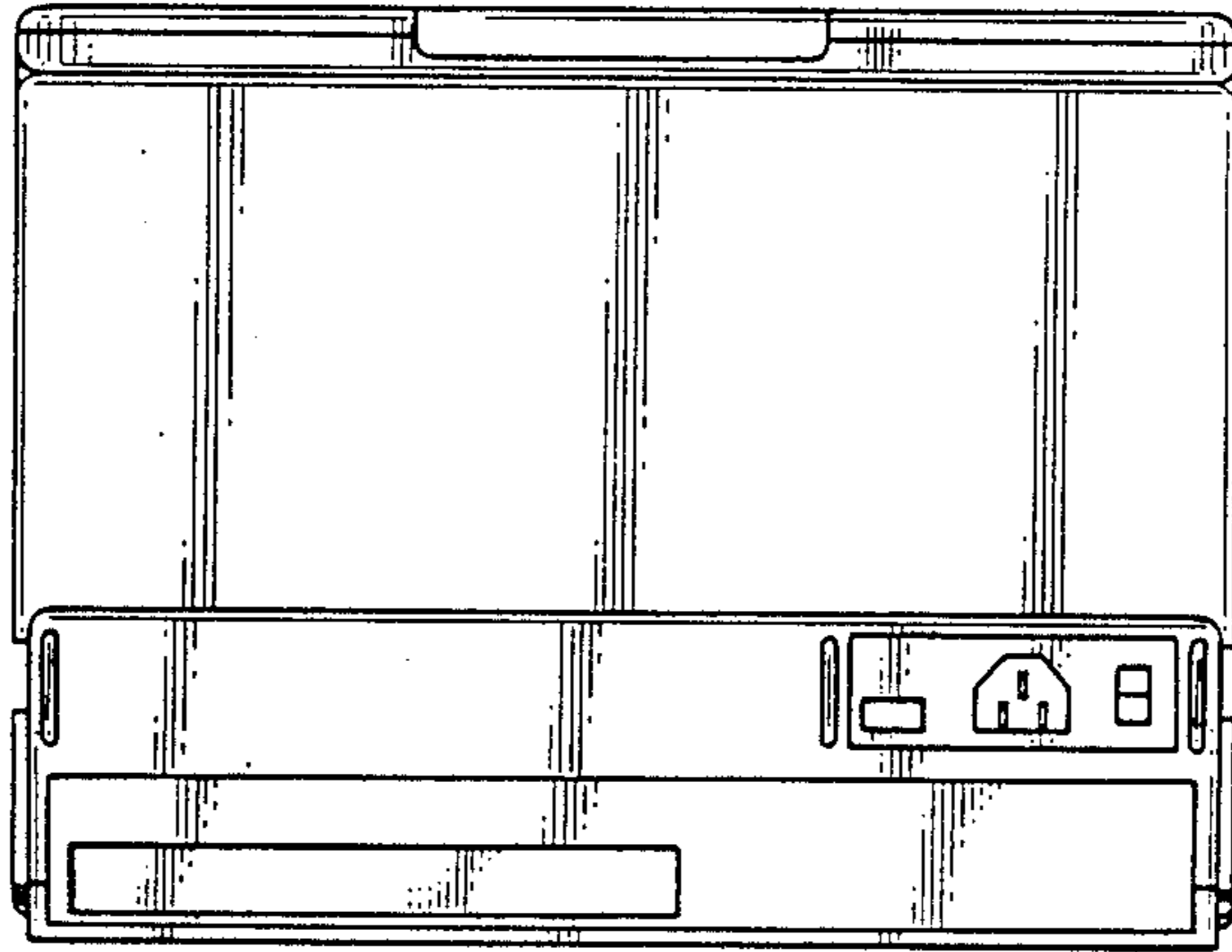

FIG. 7

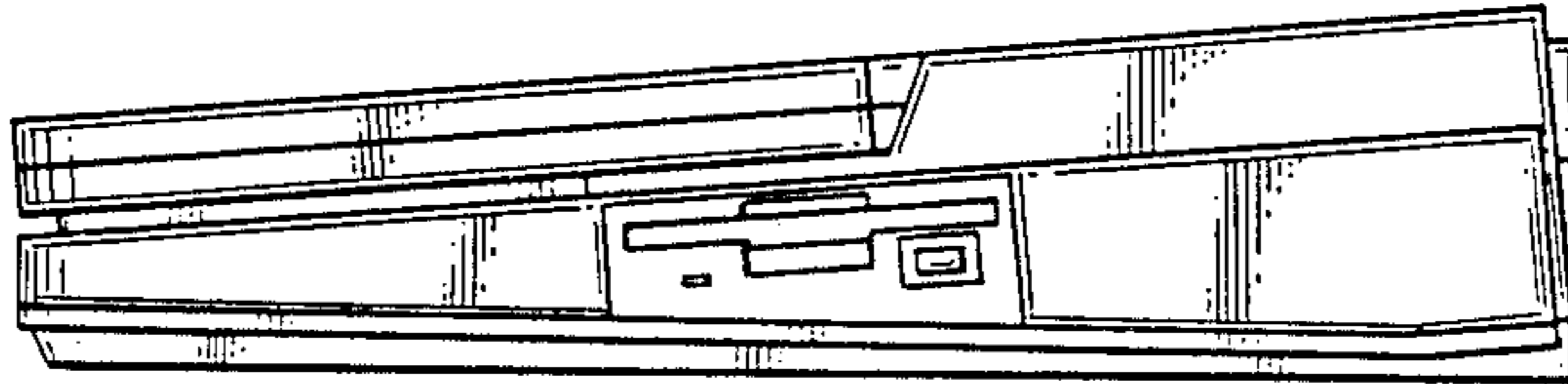

FIG. 5

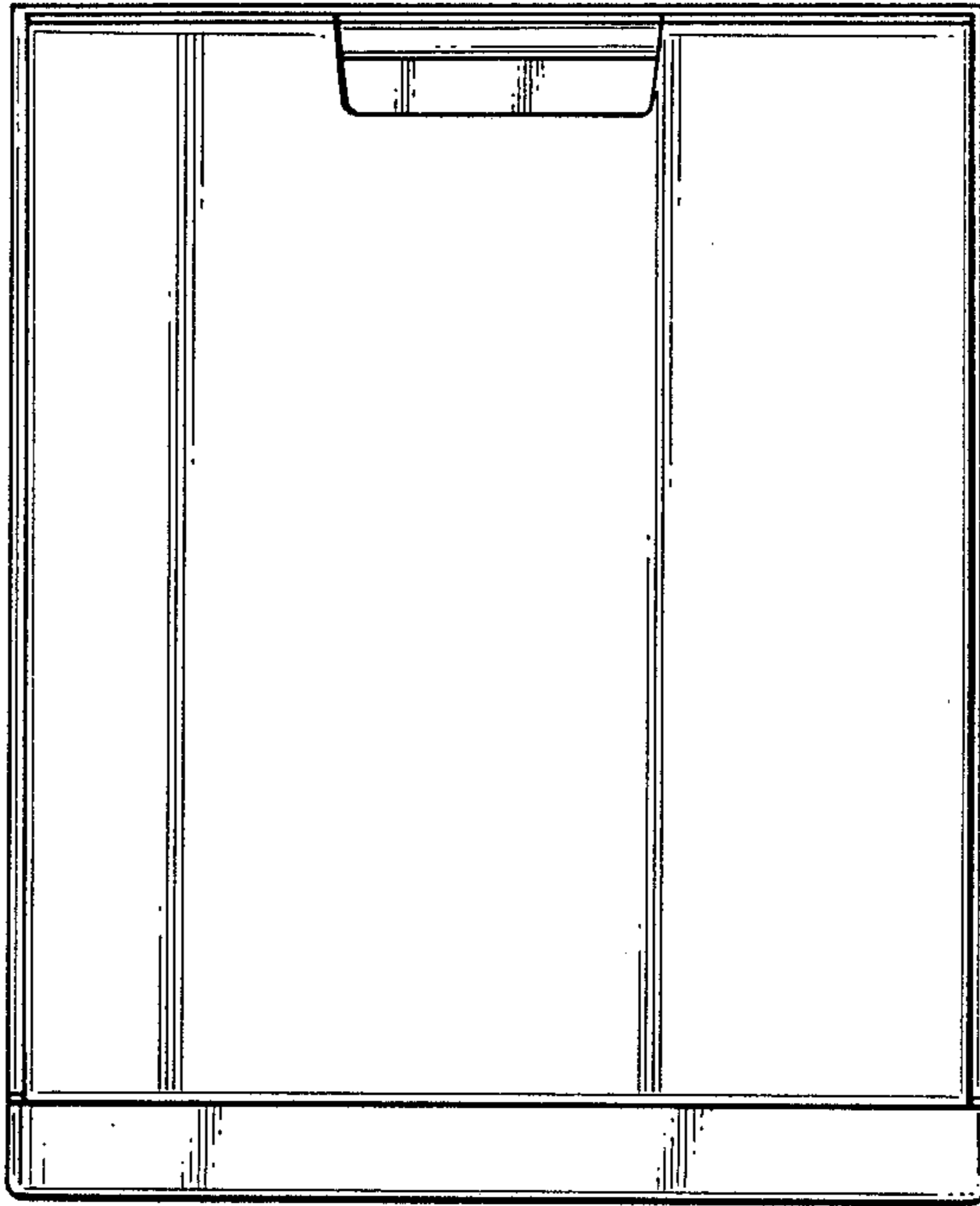

FIG. 6

