

[54] COMBINED DATA INPUT/OUTPUT
TERMINAL AND CARD READER

[75] Inventors: Shuzo Kato; Yasushi Nakamura, both
of Hiratsuka; Junnosuke Takeda,
Ninomiya, all of Japan

[73] Assignee: NCR Corporation, Dayton, Ohio

[**] Term: 14 Years

[21] Appl. No.: 101,349

[22] Filed: Sep. 25, 1987

[30] Foreign Application Priority Data

Mar. 30, 1987 [JP] Japan 62-11678

[52] U.S. Cl. D14/105; D18/4

[58] Field of Search D14/100, 102, 104-107,
D14/113, 115; D18/1, 2, 7, 11, 12; 235/145 A,
145 R, 375, 379, 380, 381, 382, 449, 470, 482;
340/700, 706, 711, 712; 341/22, 23, 26;
358/249, 254; 364/130, 144, 189, 706-710;
400/472, 479, 477, 485, 486, 489, 496, 676, 677,
682

[56] References Cited

U.S. PATENT DOCUMENTS

- D. 245,024 7/1977 Genin D18/7
- D. 274,728 7/1984 Shibata D14/113
- D. 289,873 5/1987 Gemmell et al. D14/113
- D. 294,262 2/1988 Thies et al. D14/113
- D. 295,761 5/1988 Nishibori et al. D14/100 X
- 4,438,328 3/1984 Kuranishi et al. 235/482 X
- 4,438,458 3/1984 Münscher 358/249 X
- 4,445,871 5/1984 Becker D18/12 X
- 4,525,746 6/1985 Mangold et al. 358/254
- 4,528,597 7/1985 Klein et al. 358/254
- 4,678,896 7/1987 Carlson et al. 235/380
- 4,769,764 9/1988 Levanon 364/708

OTHER PUBLICATIONS

Computer Products, Oct. 1985, p. 27-The Cherry Flat
Screen Display.

Primary Examiner—Susan J. Lucas
Assistant Examiner—Freda S. Nunn
Attorney, Agent, or Firm—Wilbert Hawk, Jr.; Albert L.
Sessler, Jr.; George J. Muckenthaler

[57] CLAIM

The ornamental design for a combined data input/out-
put terminal and card reader, as shown and described.

DESCRIPTION

FIG. 1 is a top, front, right side perspective view of a
modular keyboard or similar article showing our new
design;

FIG. 2 is a front elevational view thereof;

FIG. 3 is a rear elevational view thereof;

FIG. 4 is a right side elevational view thereof;

FIG. 5 is a left side elevational view thereof;

FIG. 6 is a top plan view thereof;

FIG. 7 is a top, front, right side perspective view of a
second embodiment showing our new design, the front
elevational view and the rear elevational view being
similar to FIGS. 2 and 3, respectively;

FIG. 8 is a right side elevational view thereof;

FIG. 9 is a left side elevational view thereof;

FIG. 10 is a top plan view thereof;

FIG. 11 is a top, front, right side perspective view of a
third embodiment showing our new design, the right
side elevational view being similar to FIG. 4;

FIG. 12 is a front elevational view thereof on an en-
larged scale;

FIG. 13 is a rear elevational view thereof on an en-
larged scale; and

FIG. 14 is a left side elevational view thereof on an
enlarged scale.

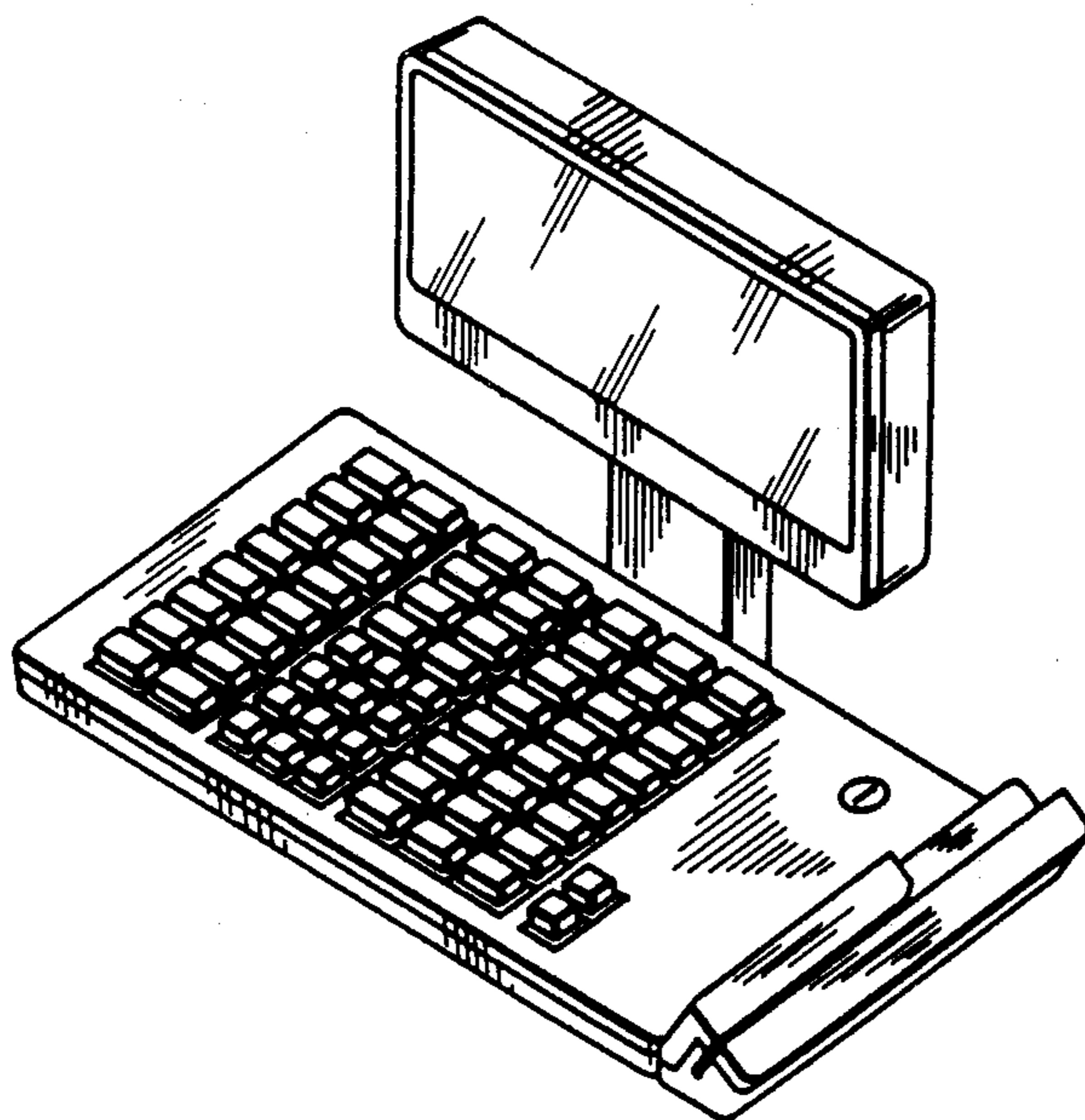

FIG. 1

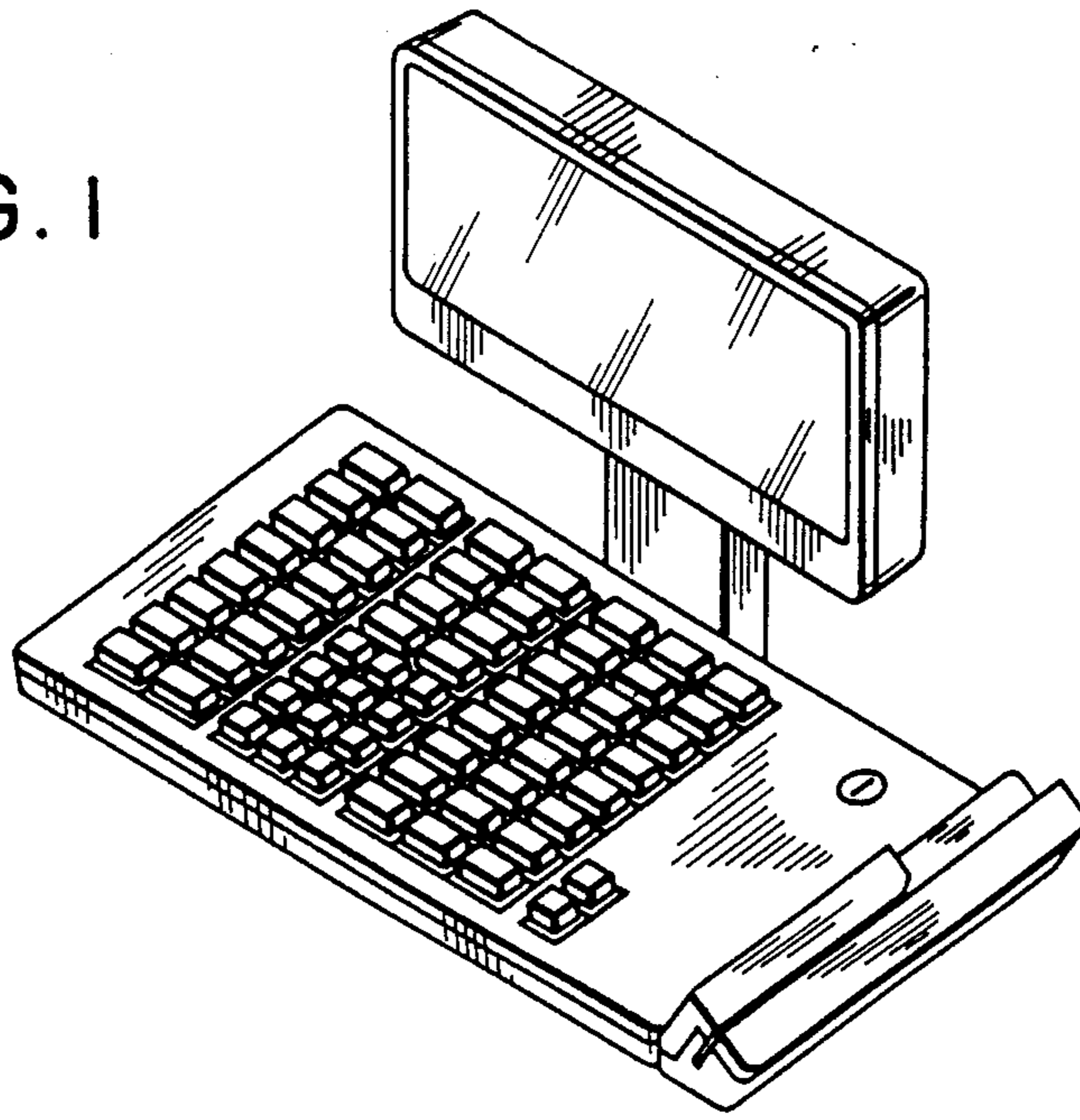

FIG. 2

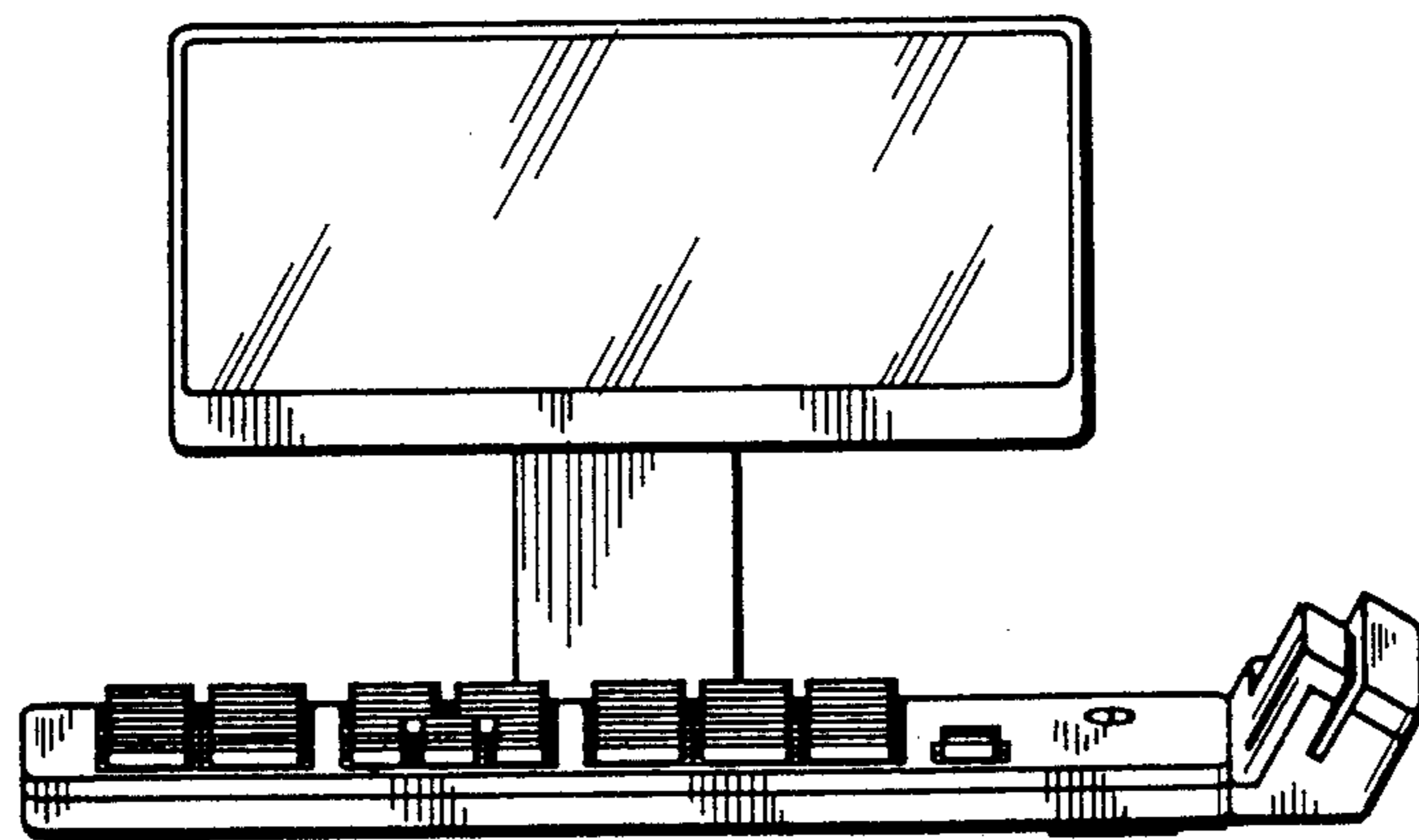

FIG. 3

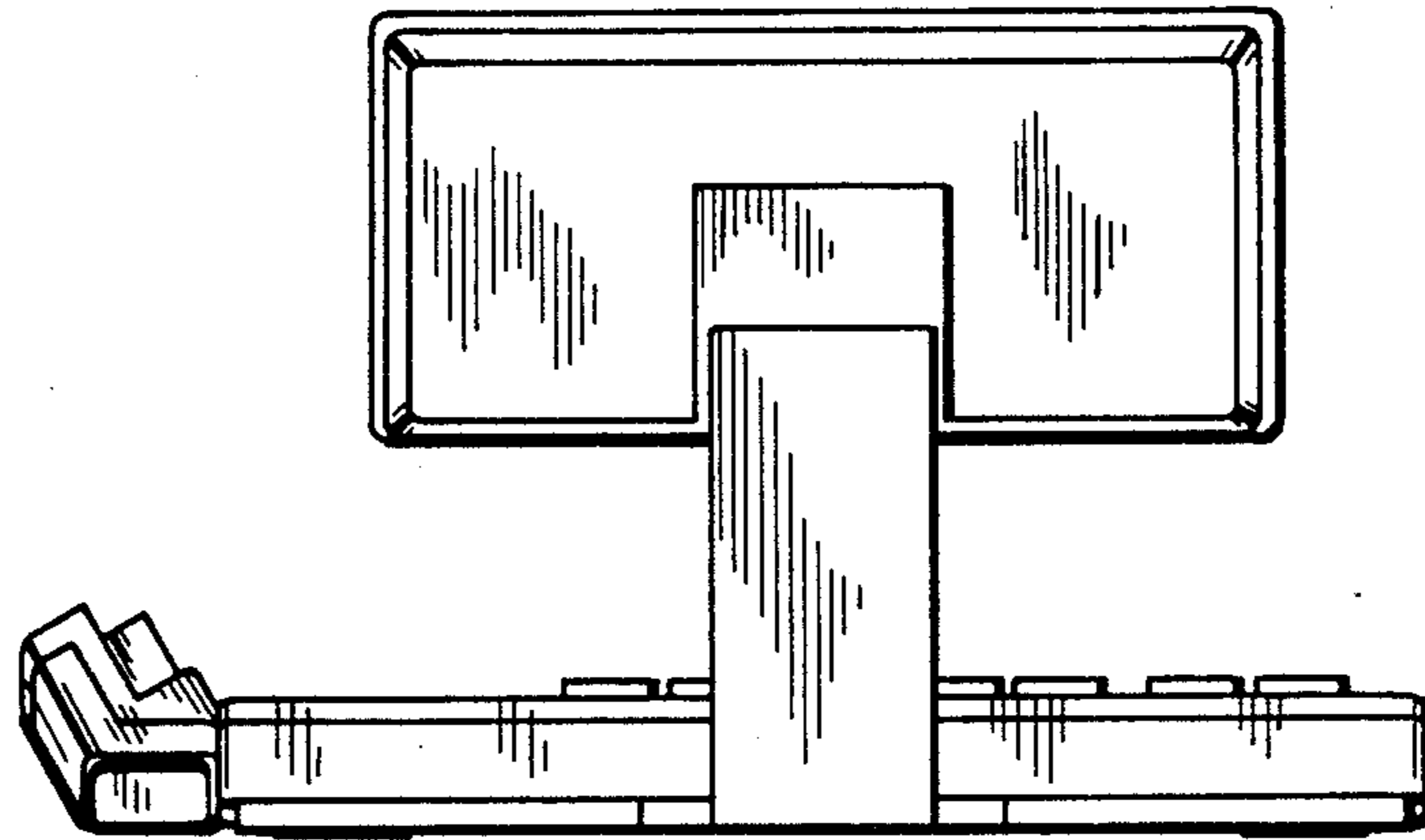

FIG. 4

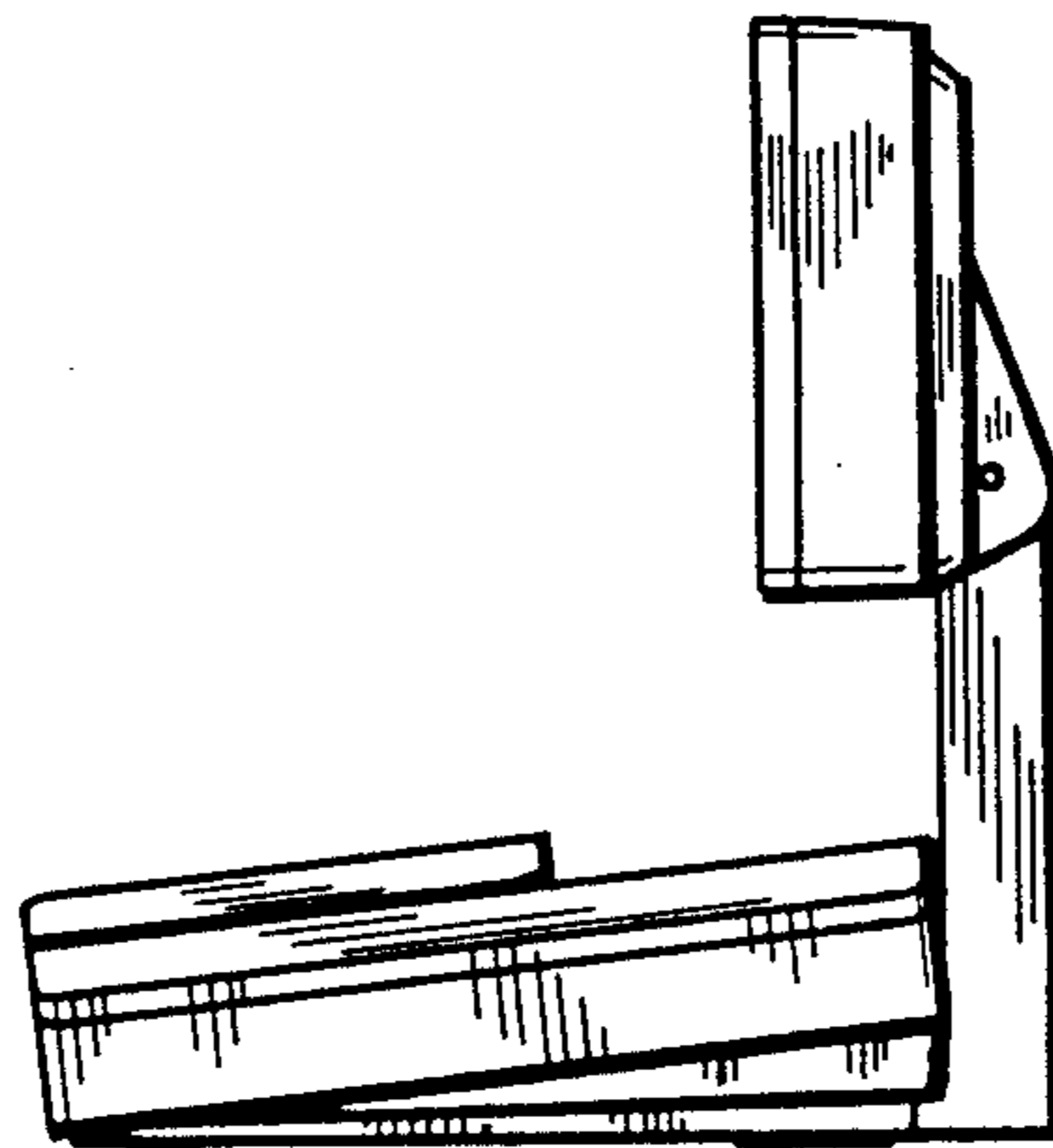

FIG. 5

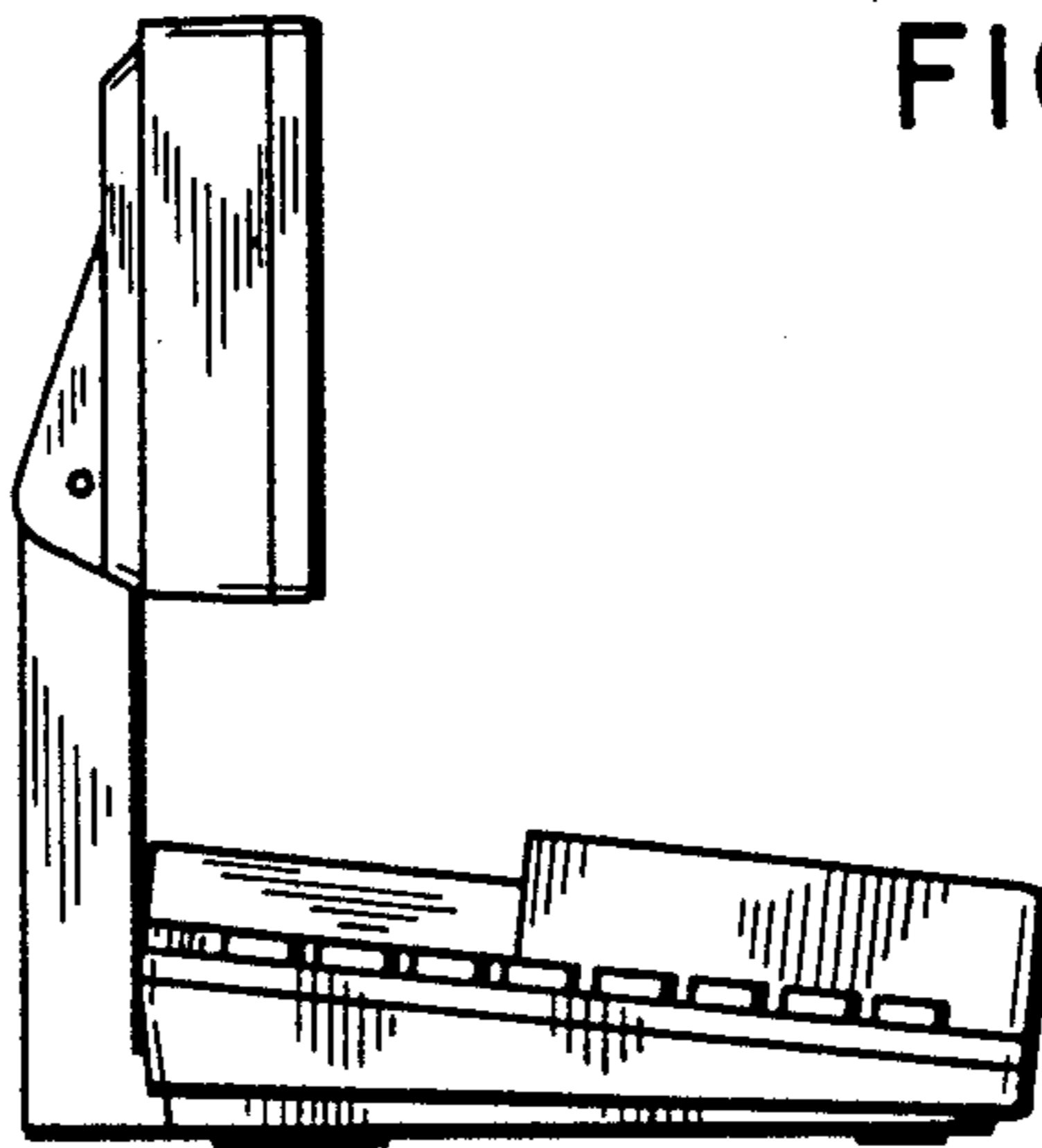

FIG. 6

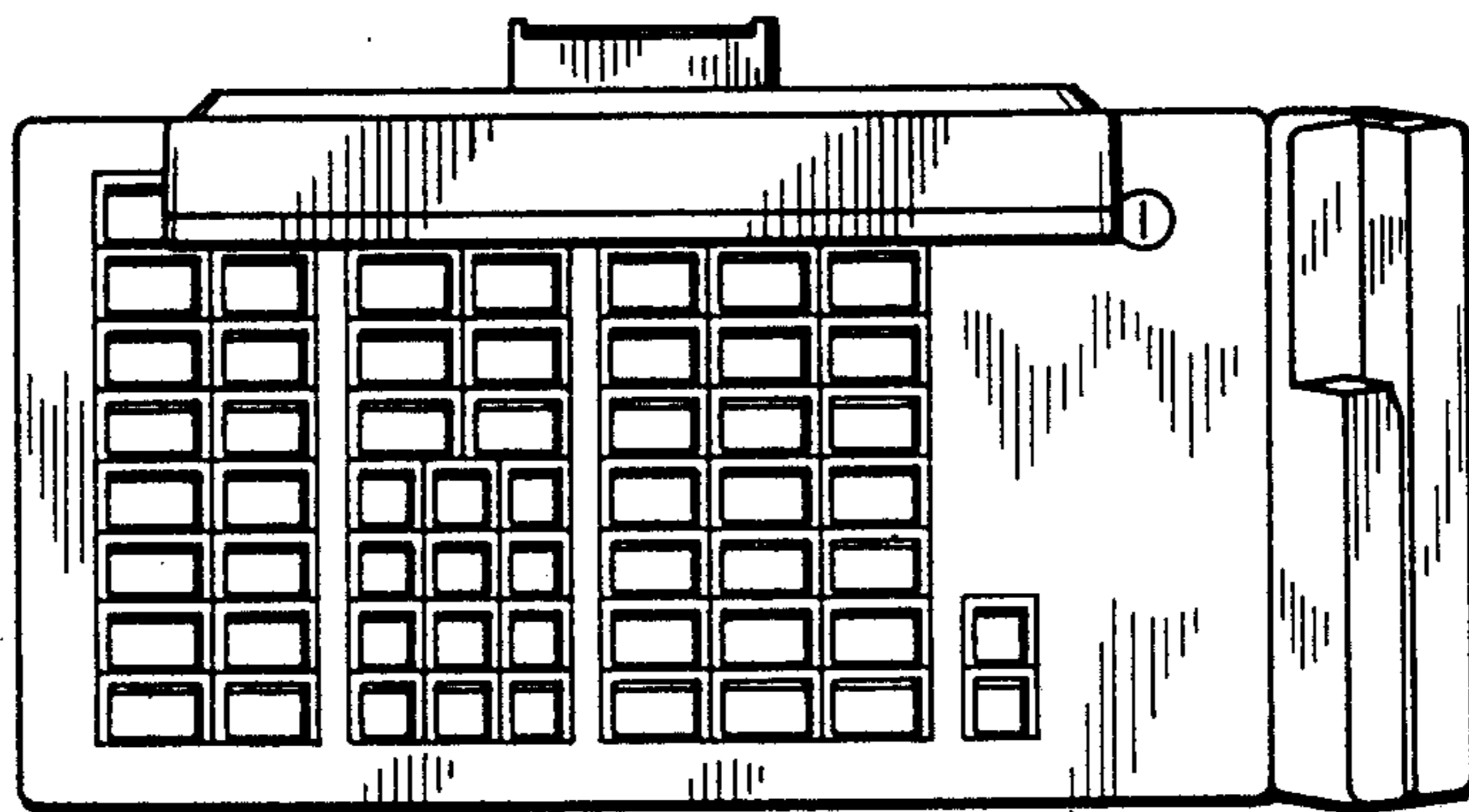

FIG. 7

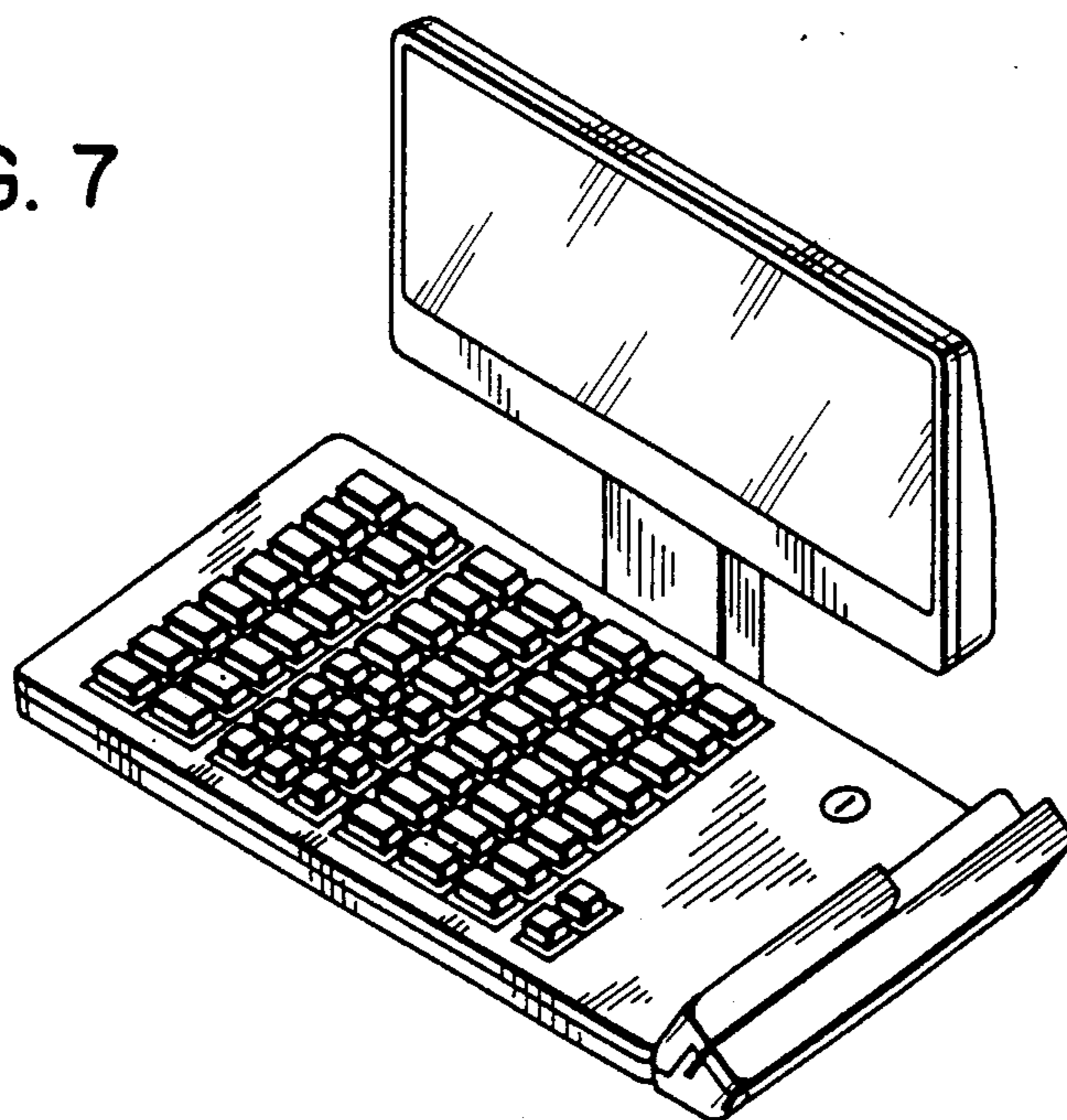

FIG. 8

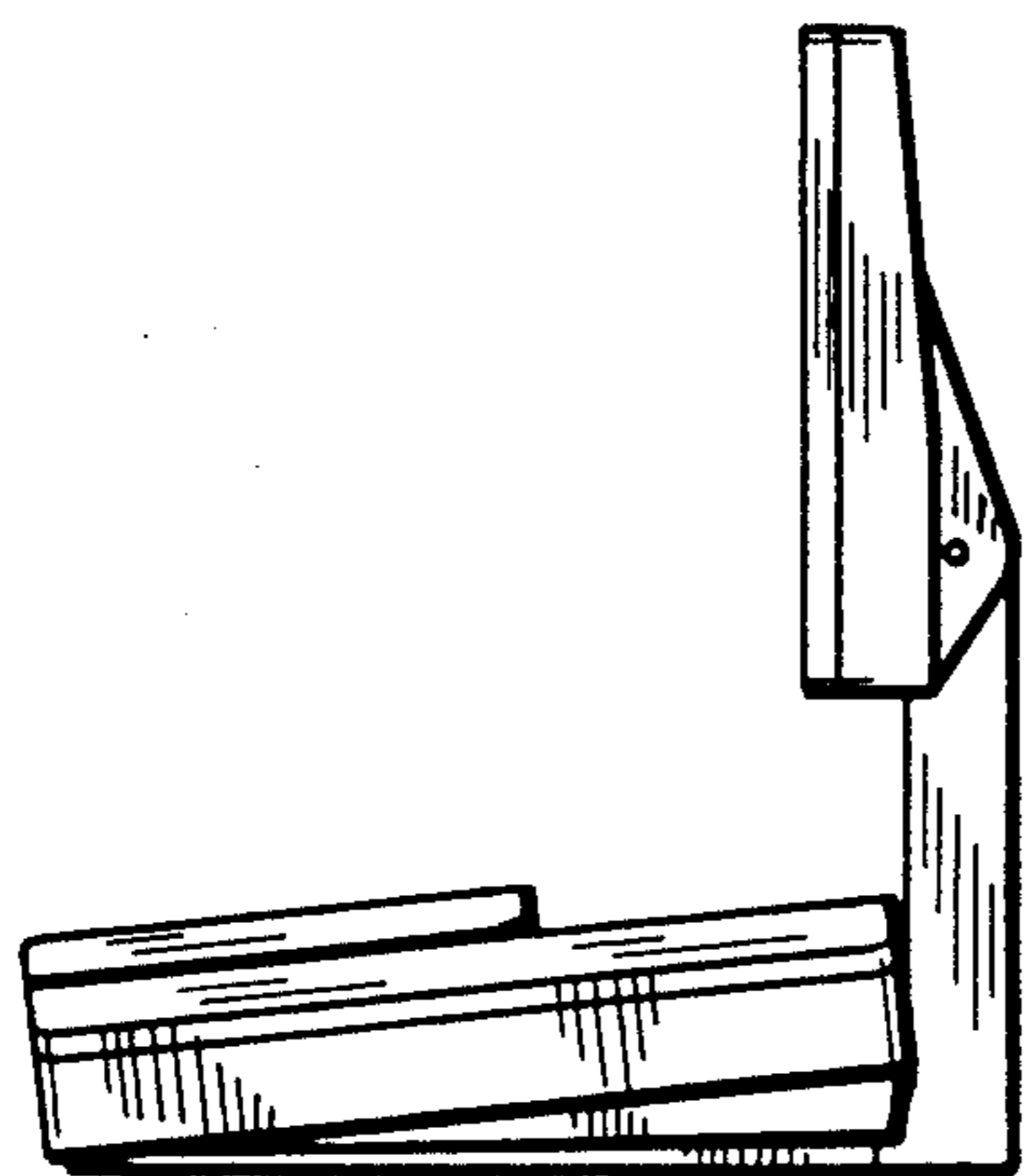

FIG. 9

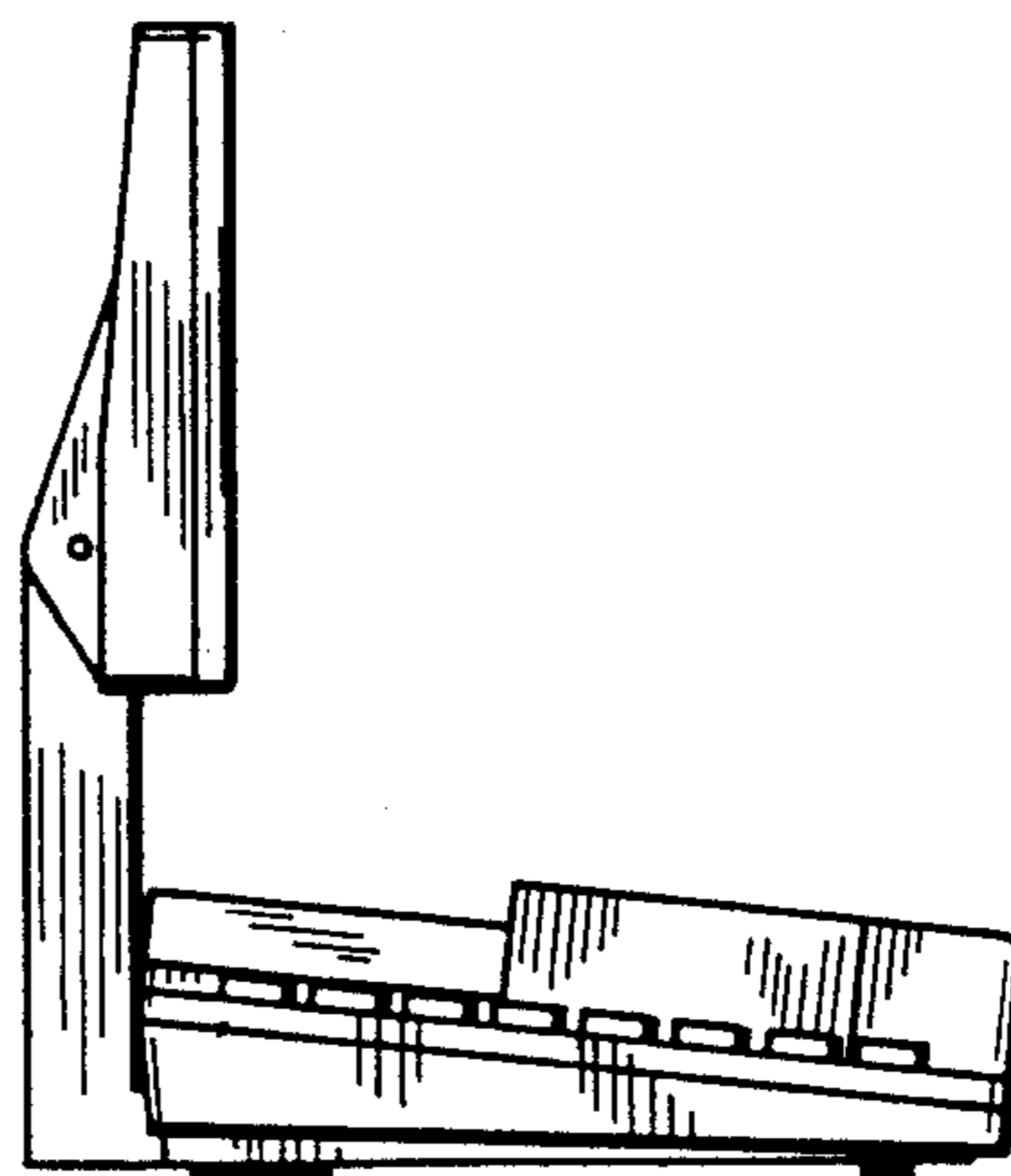

FIG. 10

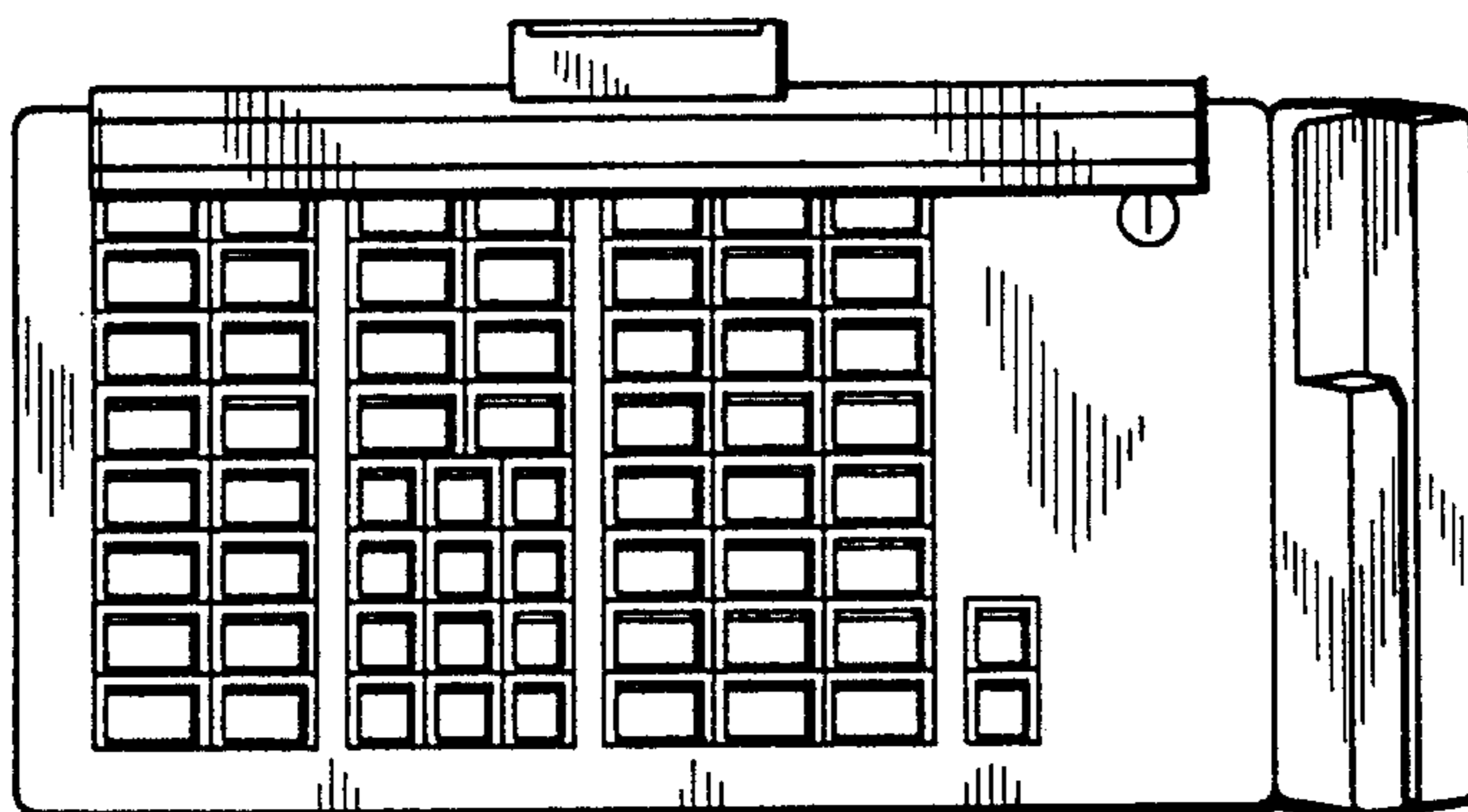
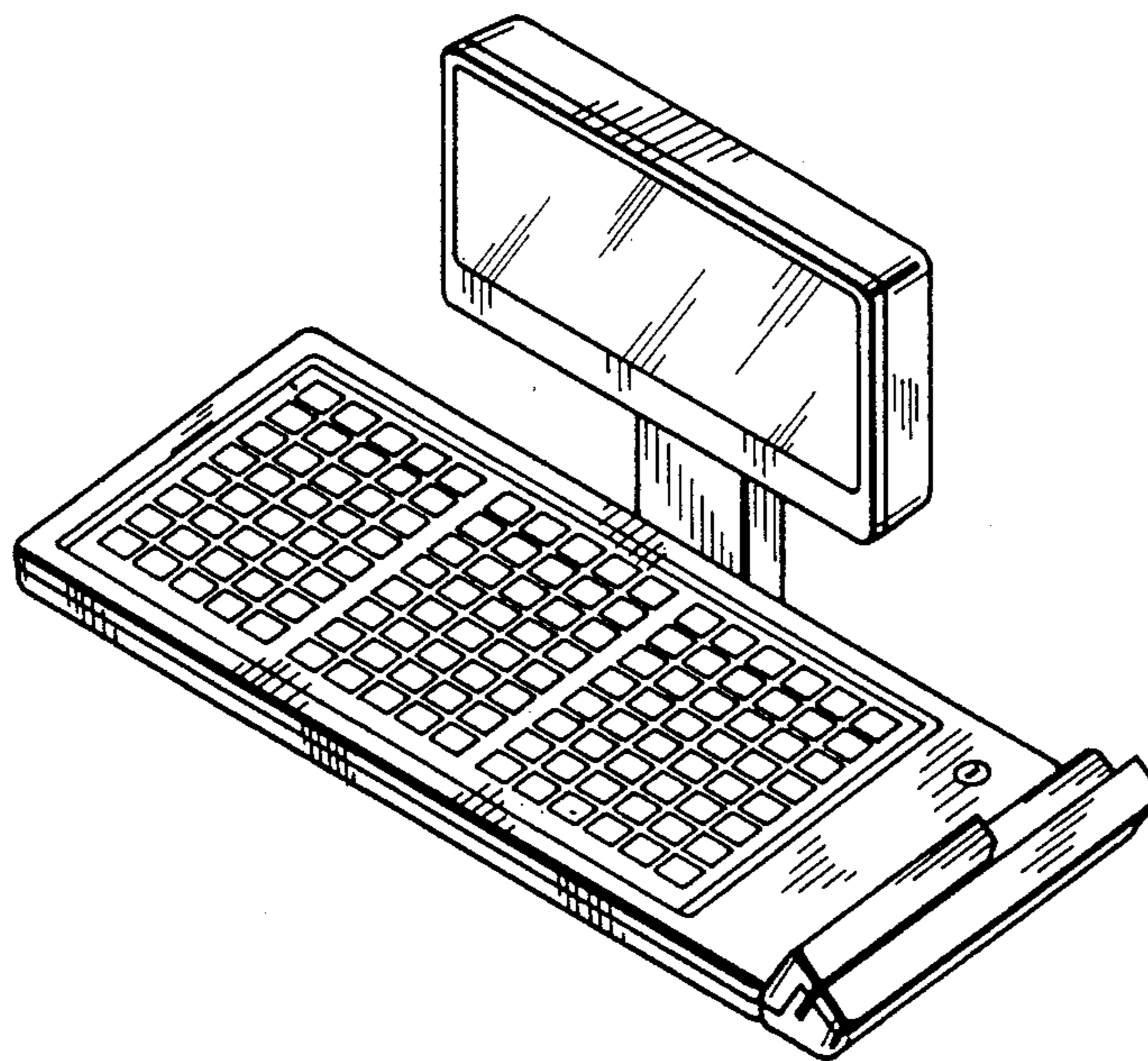

FIG. 11



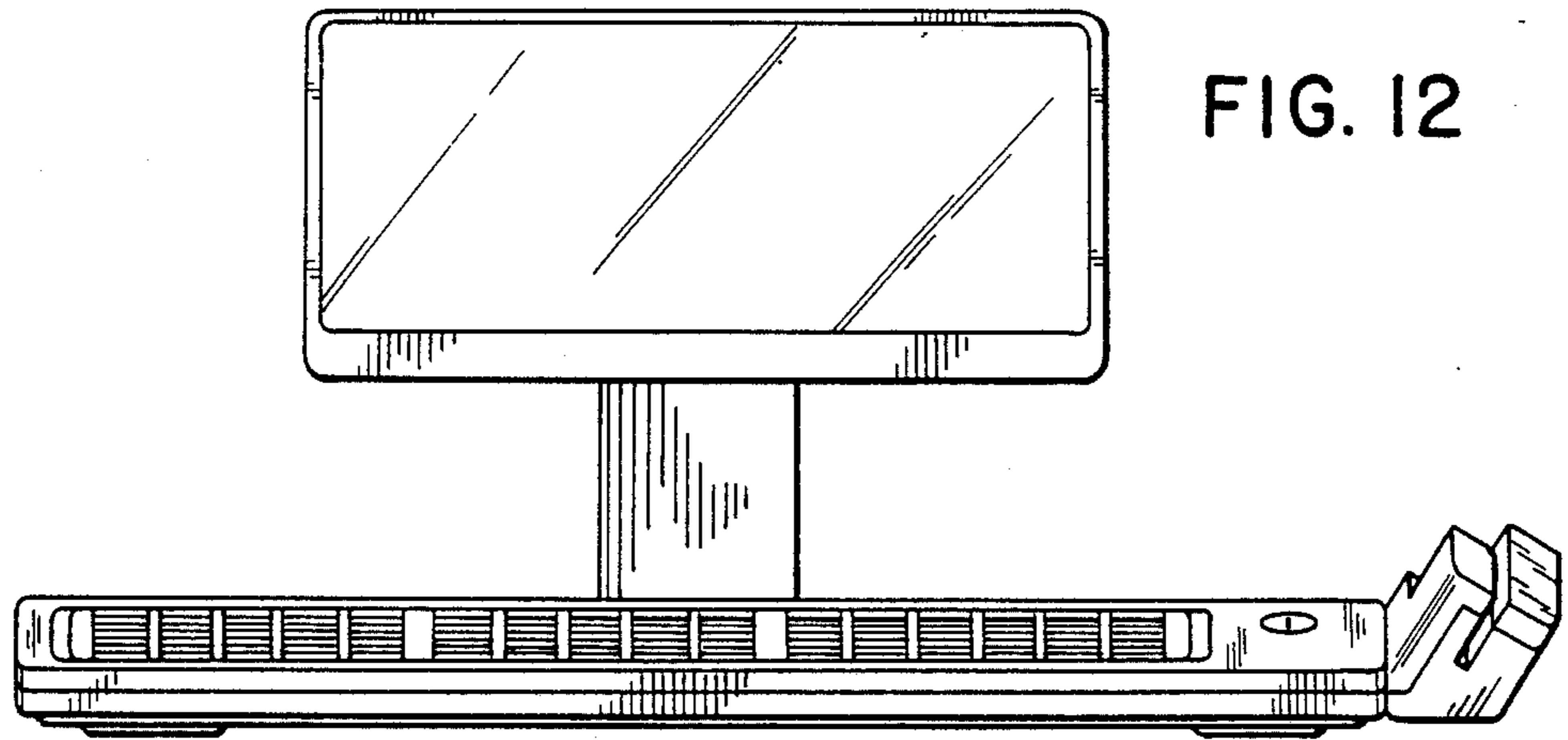

FIG. 12

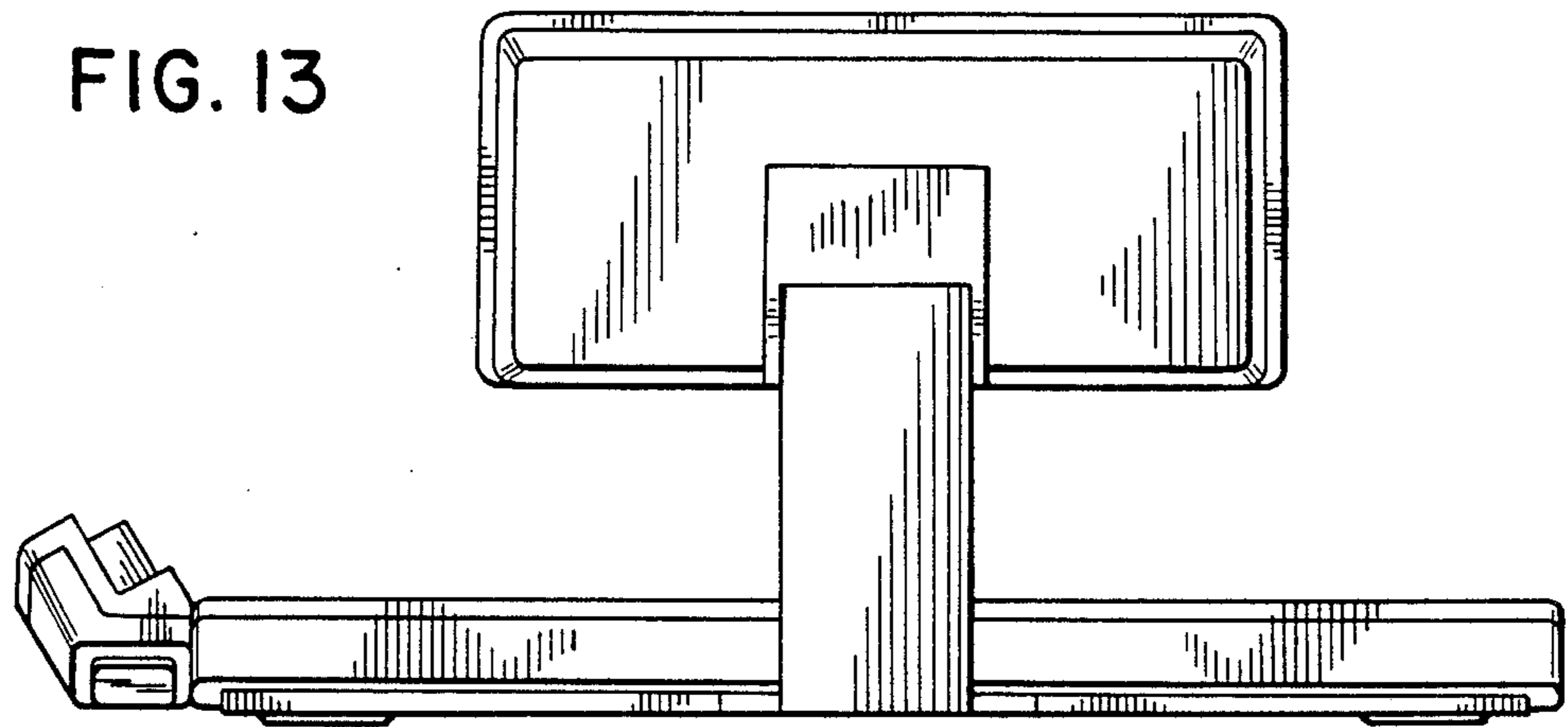

FIG. 13

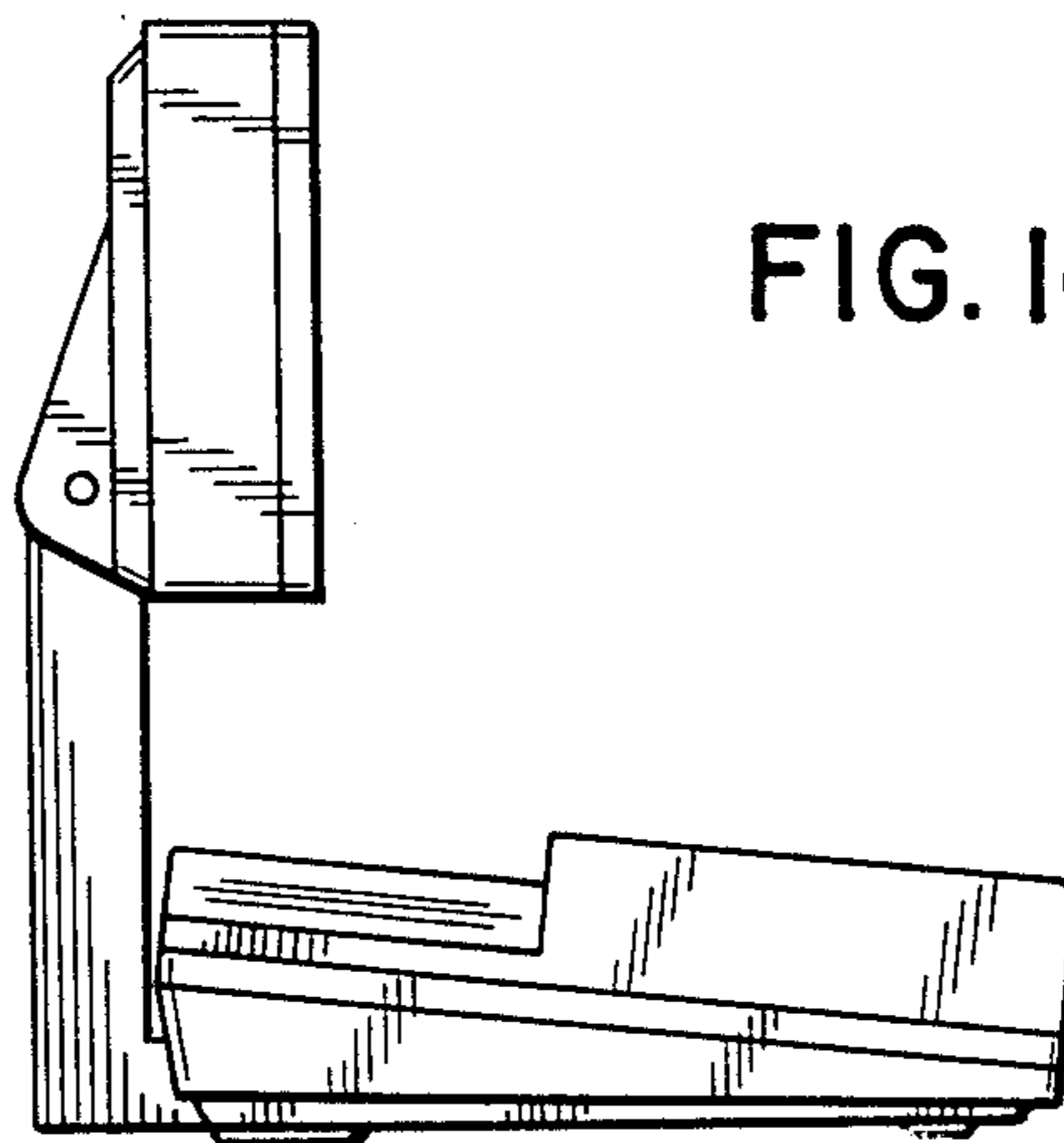

FIG. 14