

[54] **AUTOMOBILE FENDER SPOILER GUARD**

[75] **Inventor:** Pierre Charet; Duke Kraai, both of Miami, Fla.

[73] **Assignee:** Rally Manufacturing Inc., Miami, Fla.

[**] **Term:** 14 Years

[21] **Appl. No.:** 141,342

[22] **Filed:** Jan. 6, 1988

[52] **U.S. Cl.** D12/185

[58] **Field of Search** D12/185; 280/851

[56] **References Cited**

U.S. PATENT DOCUMENTS

- D. 216,255 12/1969 Bomba et al. D12/185
- D. 274,324 6/1984 Arenhold D12/185

OTHER PUBLICATIONS

J. C. Whitney Catalog No. 423, B, ©1982, p. 118, Stain-

less Steel Front Fender Mud Guards, bottom left side of page.

Primary Examiner—James M. Gandy
Attorney, Agent, or Firm—Wells & White

[57] **CLAIM**

The ornamental design for an automobile fender spoiler guard, as shown and described.

DESCRIPTION

FIG. 1 is a perspective view of an automobile fender spoiler guard showing my new design it being understood that the broken lines are for illustrative purposes only and form no part of the claimed design;
 FIG. 2 is an enlarged front elevation view thereof;
 FIG. 3 is a top plan view of FIG. 2;
 FIG. 4 is a bottom plan view of FIG. 2;
 FIG. 5 is a right side elevation view of FIG. 2;
 FIG. 6 is a rear elevation view of FIG. 2; and
 FIG. 7 is a left side elevation view of FIG. 2.

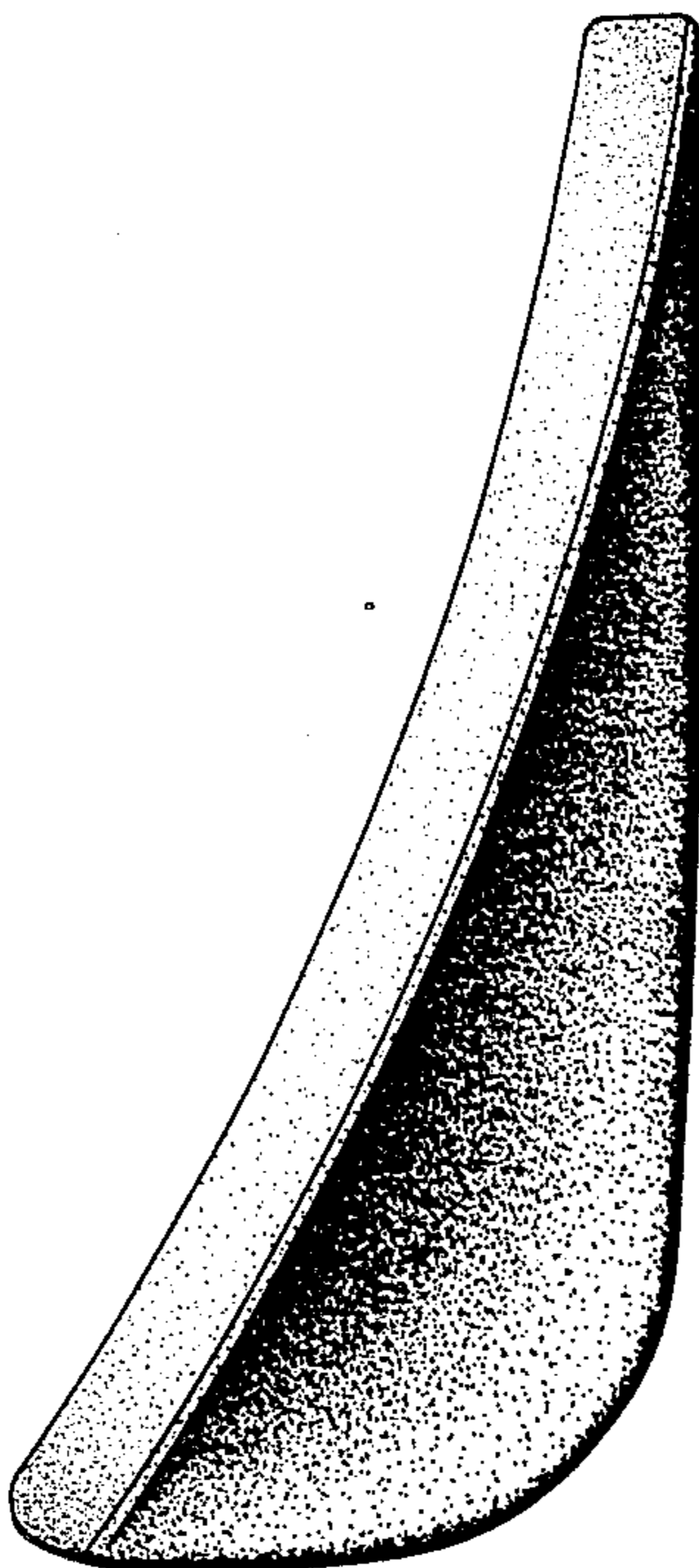

FIG. 1

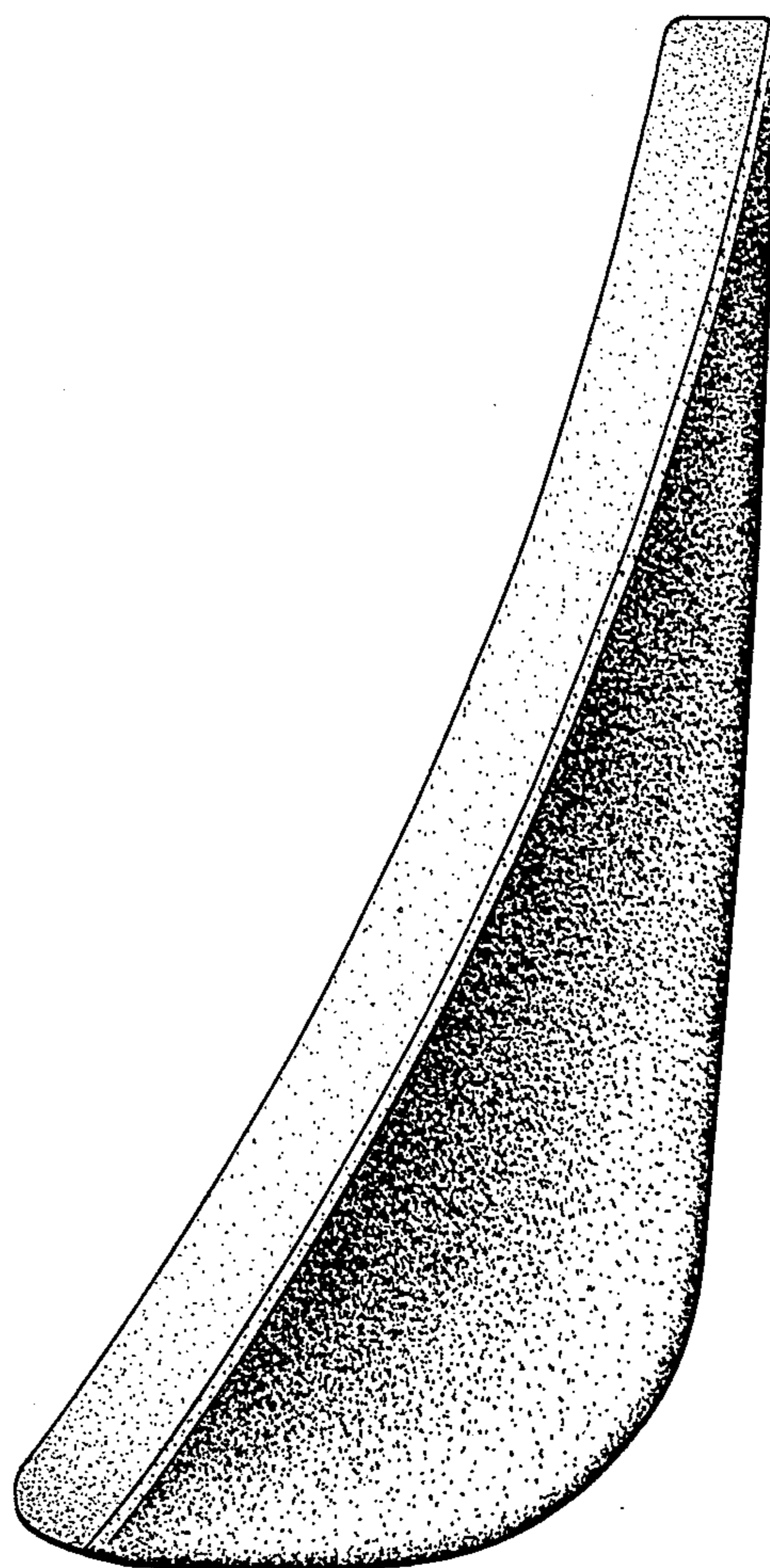
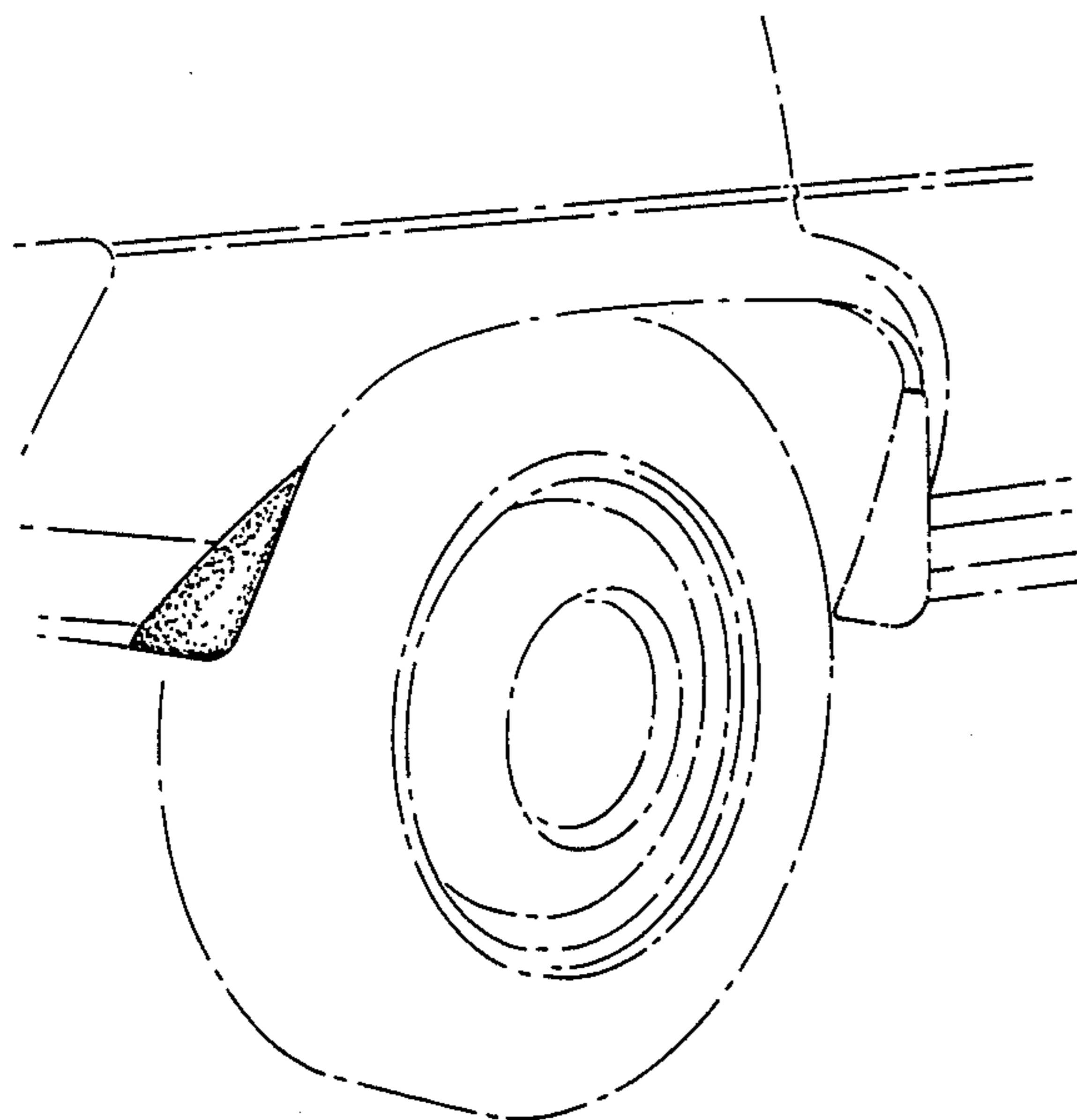

FIG. 2

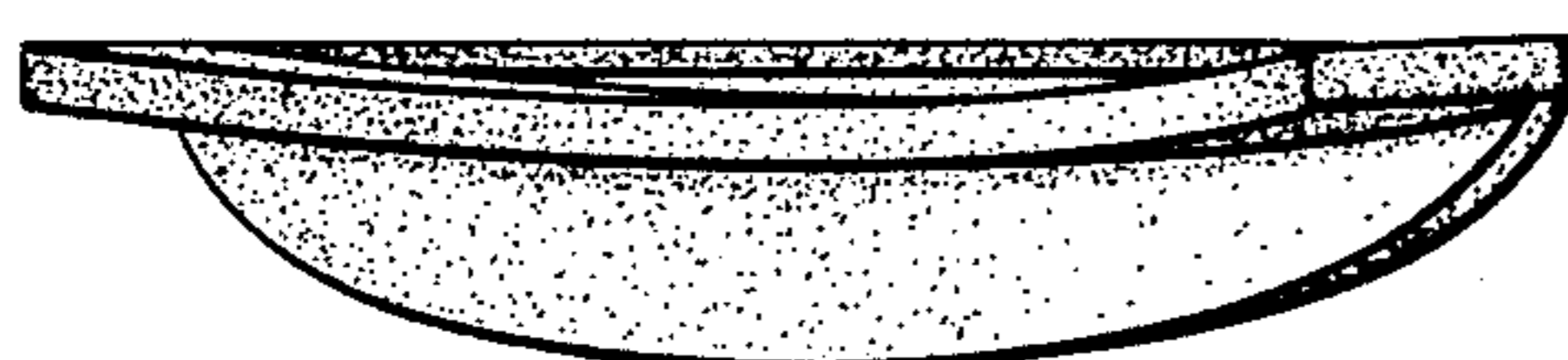

FIG. 3

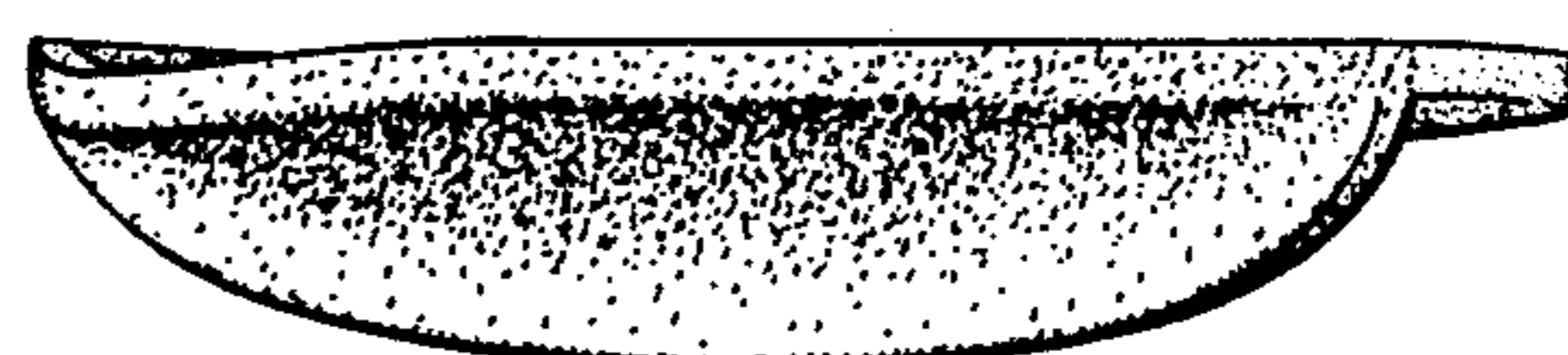

FIG. 4

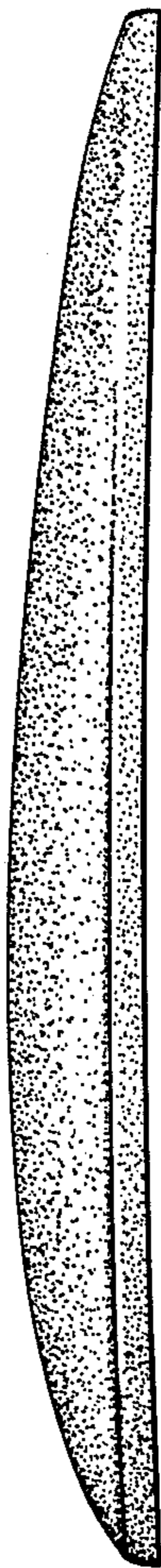

FIG. 5

FIG. 6

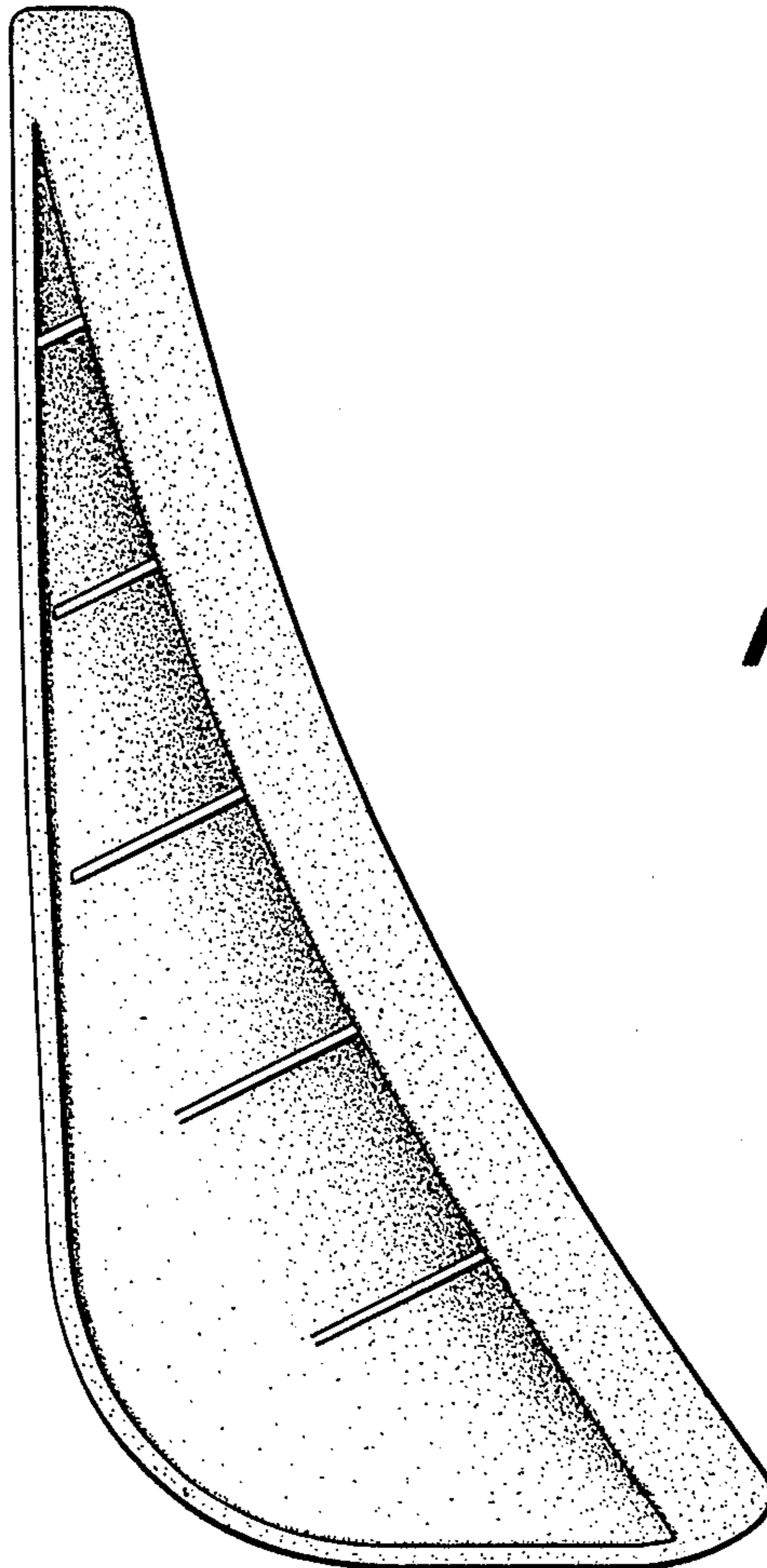

FIG. 7

