

- [54] **COMBINED HAIR TRIMMER WITH CHARGING STAND THEREFORE**
- [75] Inventors: **George P. Gallanis, Sterling; Stephen Gatz, Galt; Kenneth M. Hattori, Bensenville, all of Ill.**
- [73] Assignee: **Wahl Clipper Corporation, Sterling, Ill.**
- [**] Term: **14 Years**
- [21] Appl. No.: **80,576**
- [22] Filed: **Aug. 3, 1987**
- [52] U.S. Cl. **D28/53**
- [58] Field of Search **D28/44-54; 30/29.5, 32, 34 R, 34.1, 41.9, 42, 43.92, 90, 84-86, 200-202, 210, 220**

- [56] **References Cited**
- U.S. PATENT DOCUMENTS**
- D. 219,902 2/1971 Walton et al. D28/53
- D. 287,648 1/1987 Wahl et al. D28/53
- 1,515,555 11/1924 Derby 30/220 X
- 3,589,007 6/1971 Walton 30/210

- 4,542,585 9/1985 Ito et al. 30/210
- FOREIGN PATENT DOCUMENTS**
- 59-51877 3/1984 Japan .

OTHER PUBLICATIONS

Wahl Clipper Corporation, Model No. 8080, Hair Clipper.

Primary Examiner—Louis S. Zarfes
Attorney, Agent, or Firm—Welsh & Katz, Ltd.

[57] **CLAIM**

The ornamental design for a combined hair trimmer with charging stand therefore, as shown and described.

DESCRIPTION

FIG. 1 is a left side view of a combined hair trimmer with charging stand therefore showing our new design; FIG. 2 is a front elevational view thereof; FIG. 3 is a top plan view thereof; FIG. 4 is a rear elevational view thereof; FIG. 5 is a bottom view thereof; and FIG. 6 is a right side view thereof. The conventional power cord is shown broken away for ease of illustration.

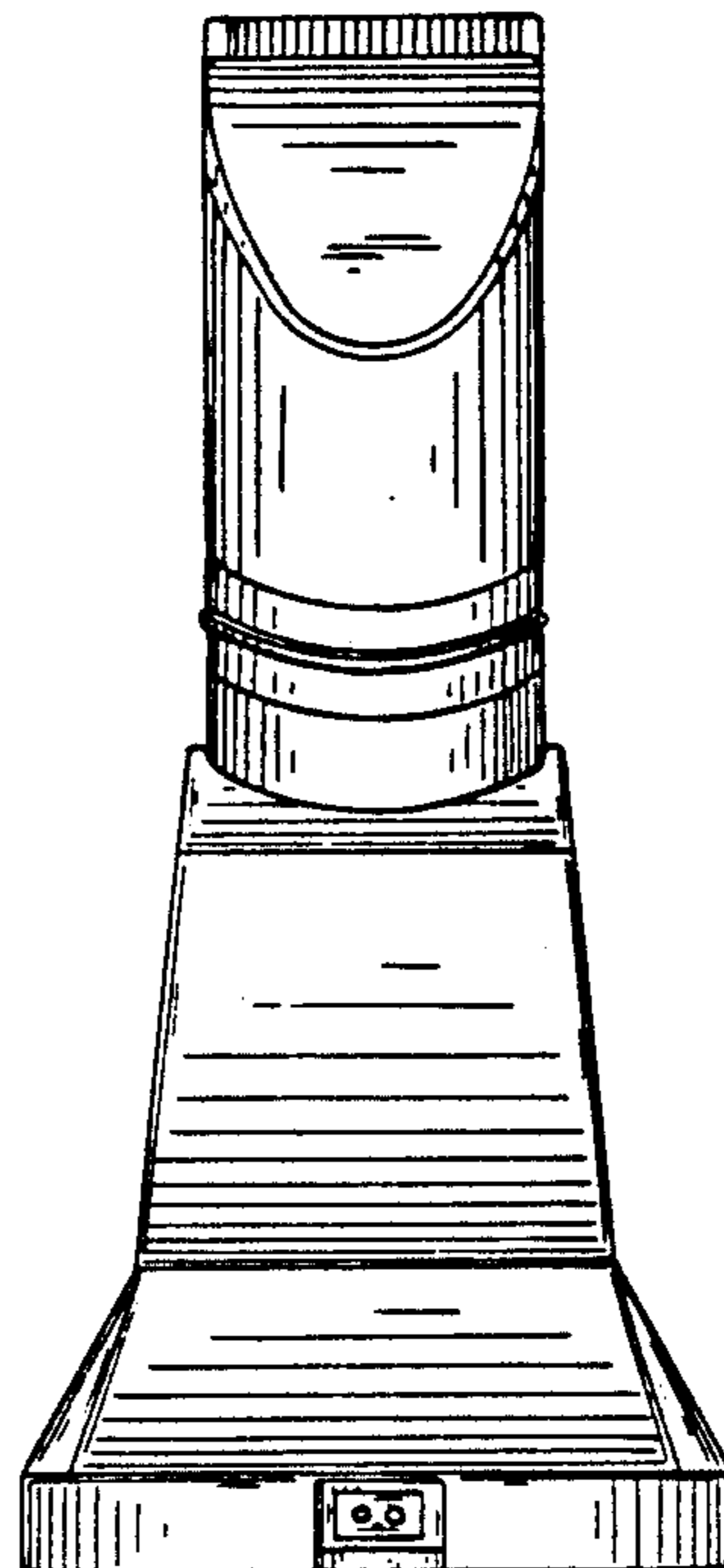
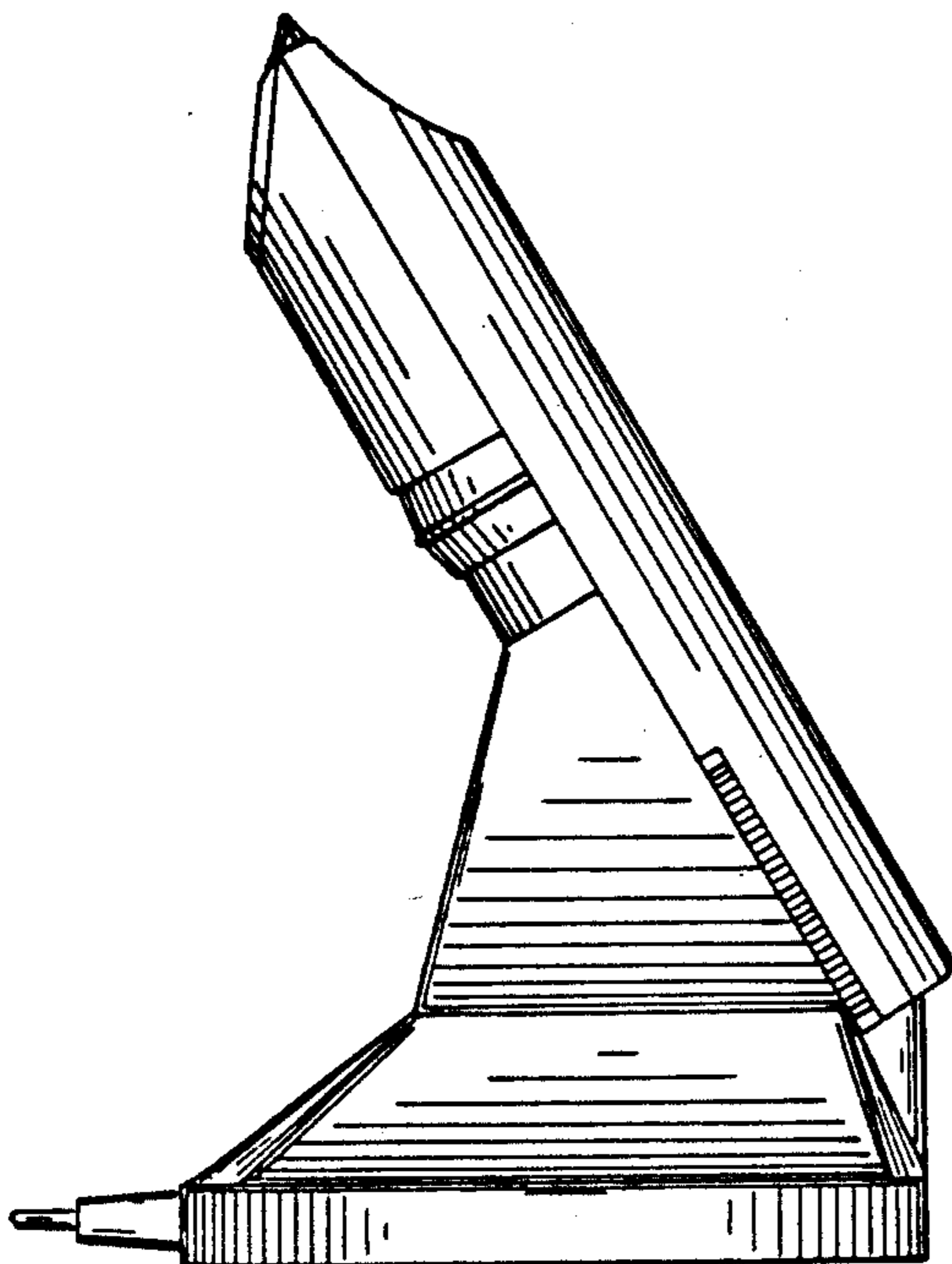

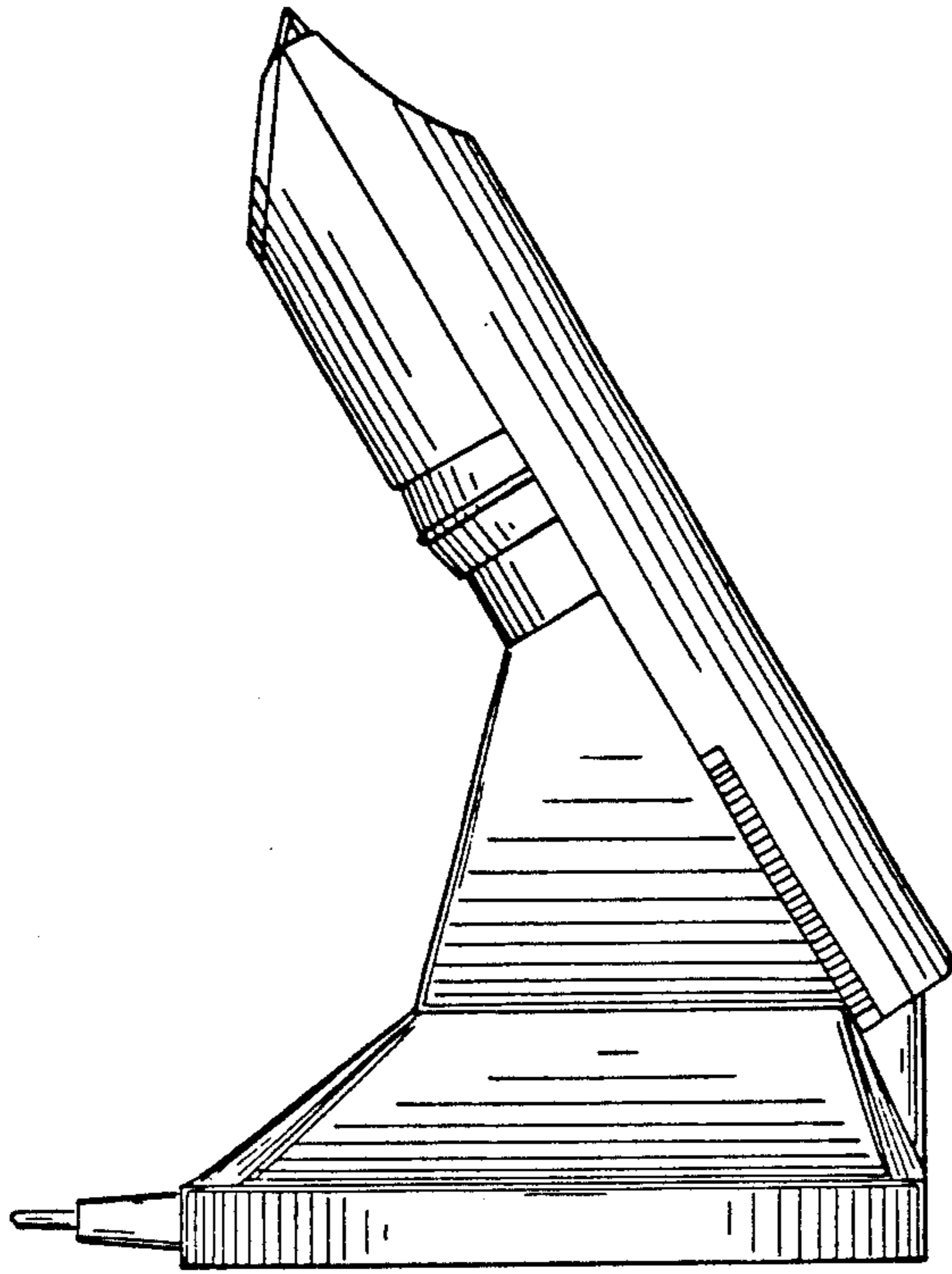

FIG. 1

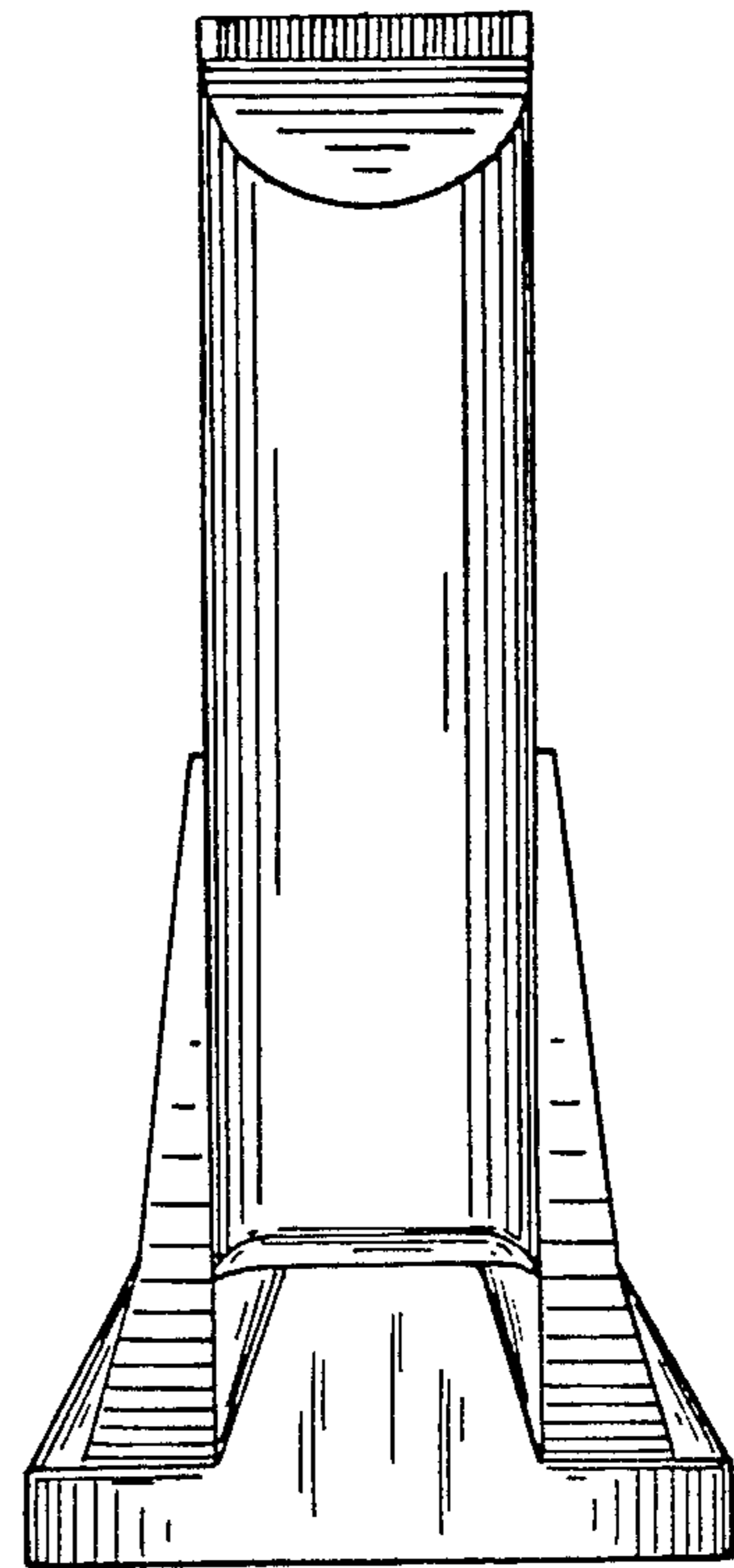

FIG. 2

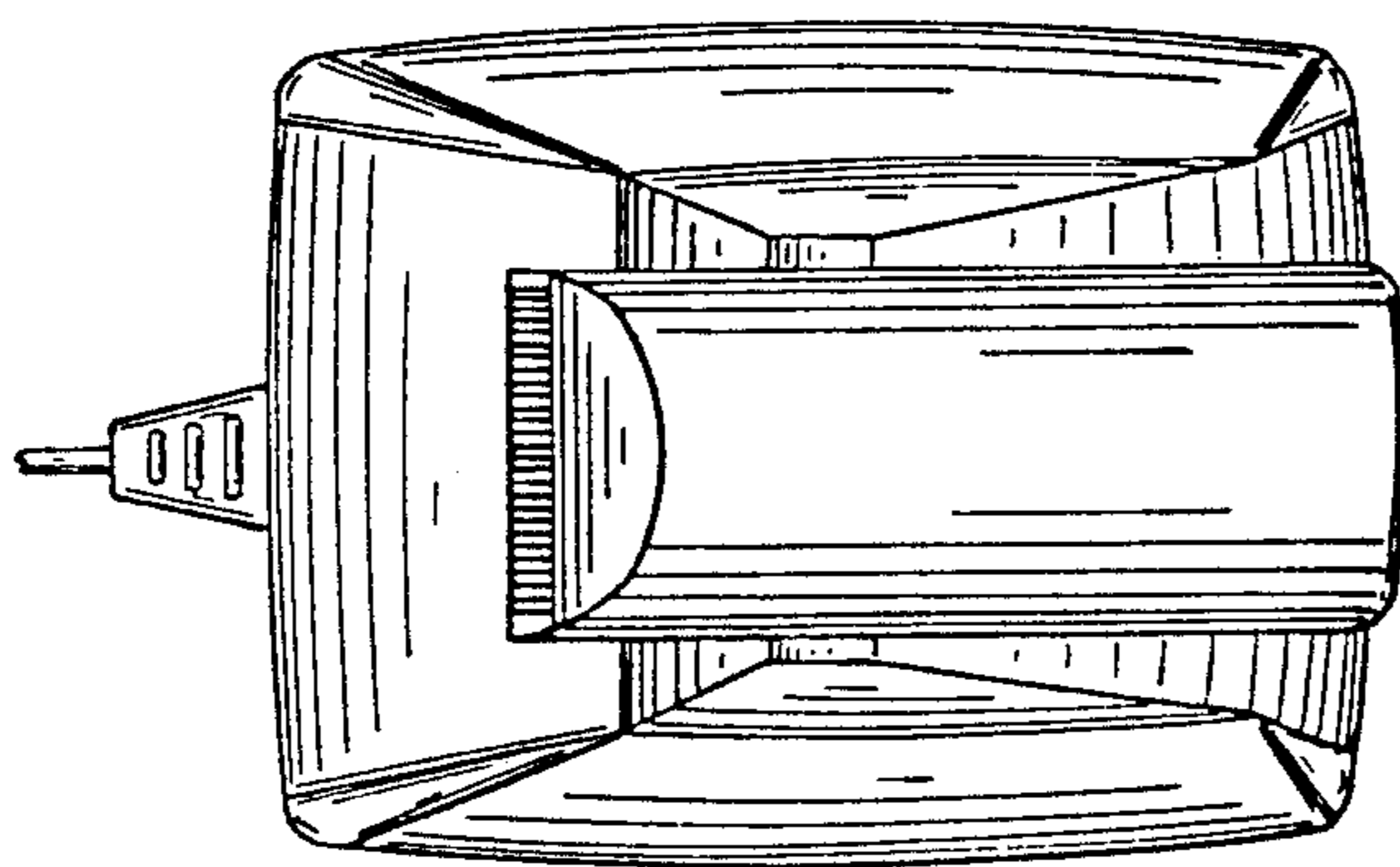

FIG. 3

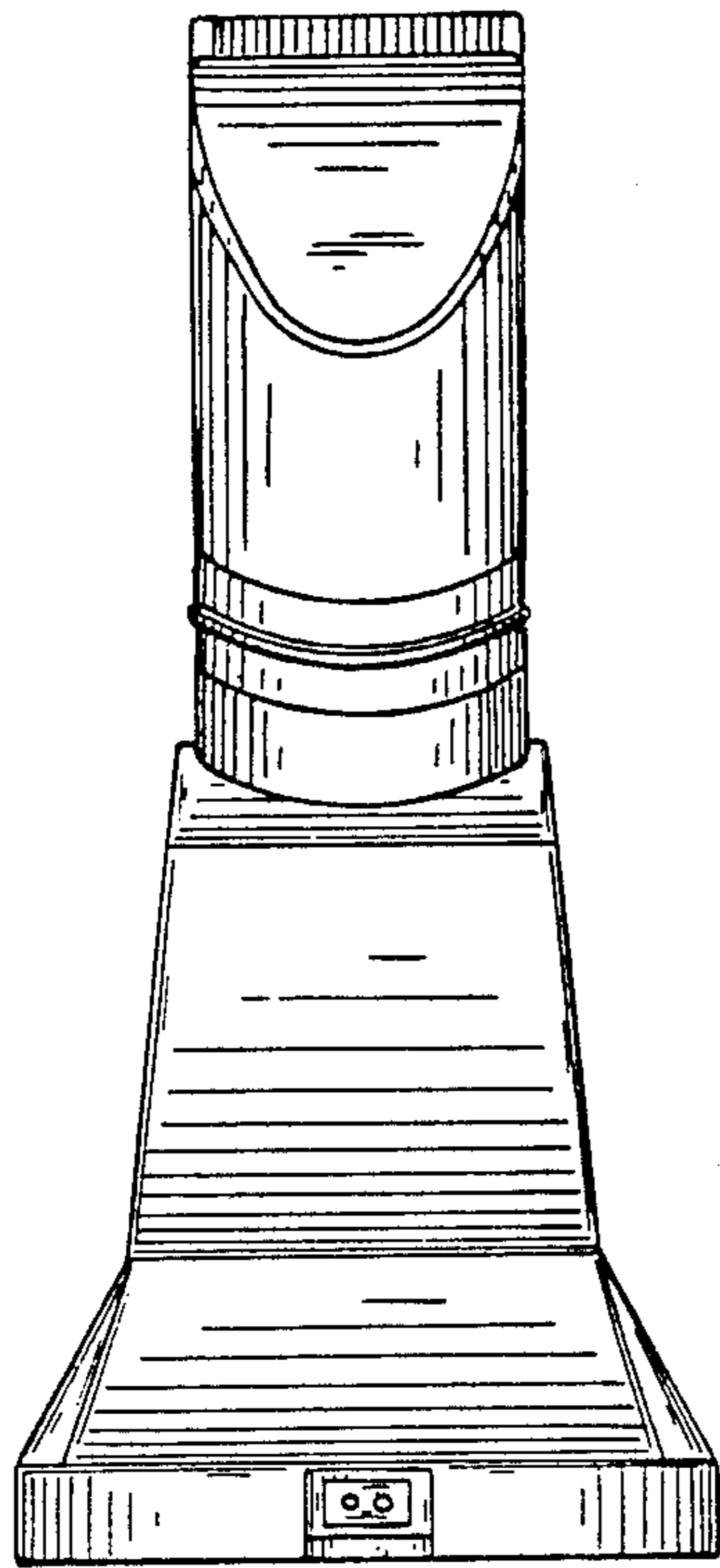

FIG. 4

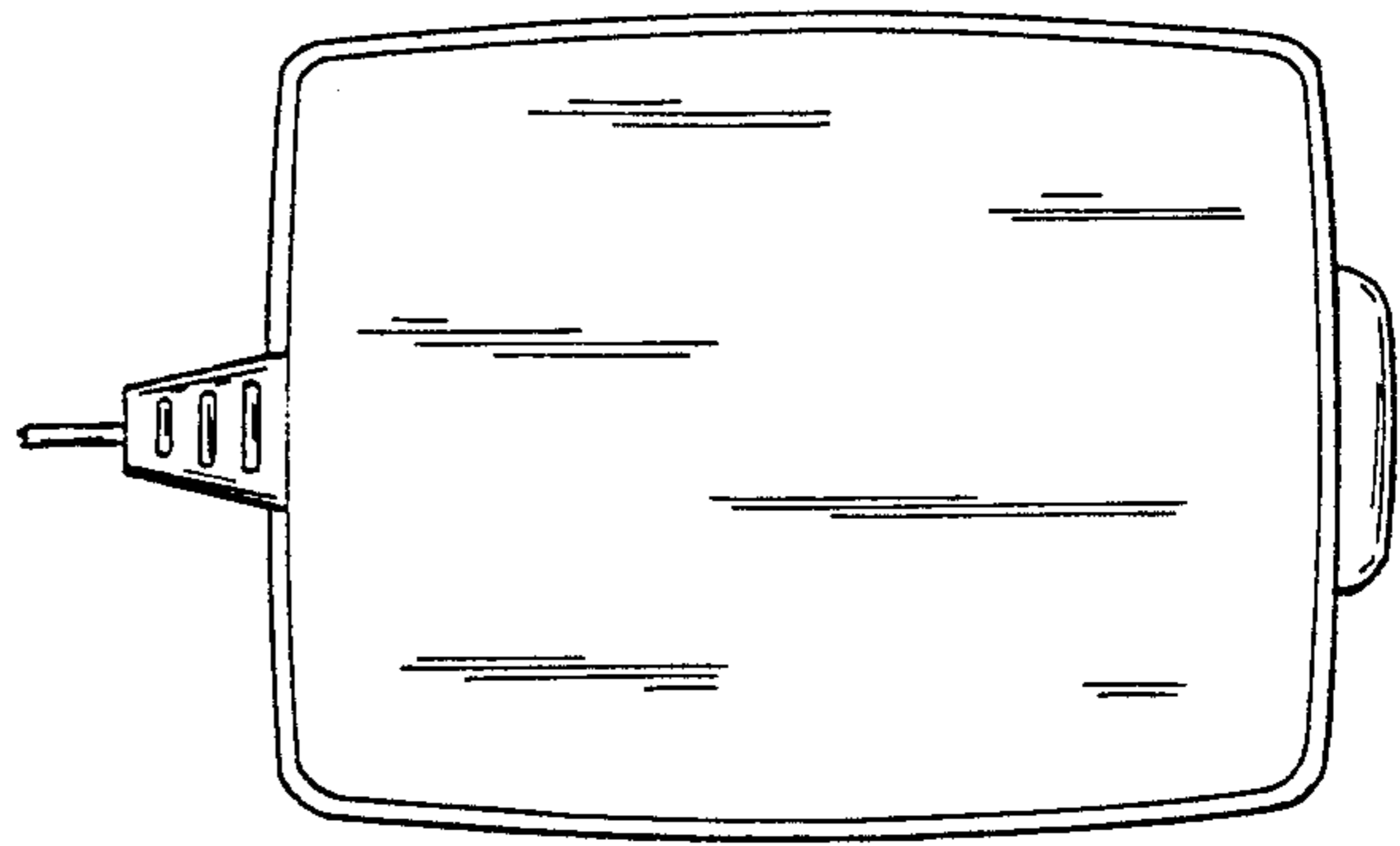

FIG. 5

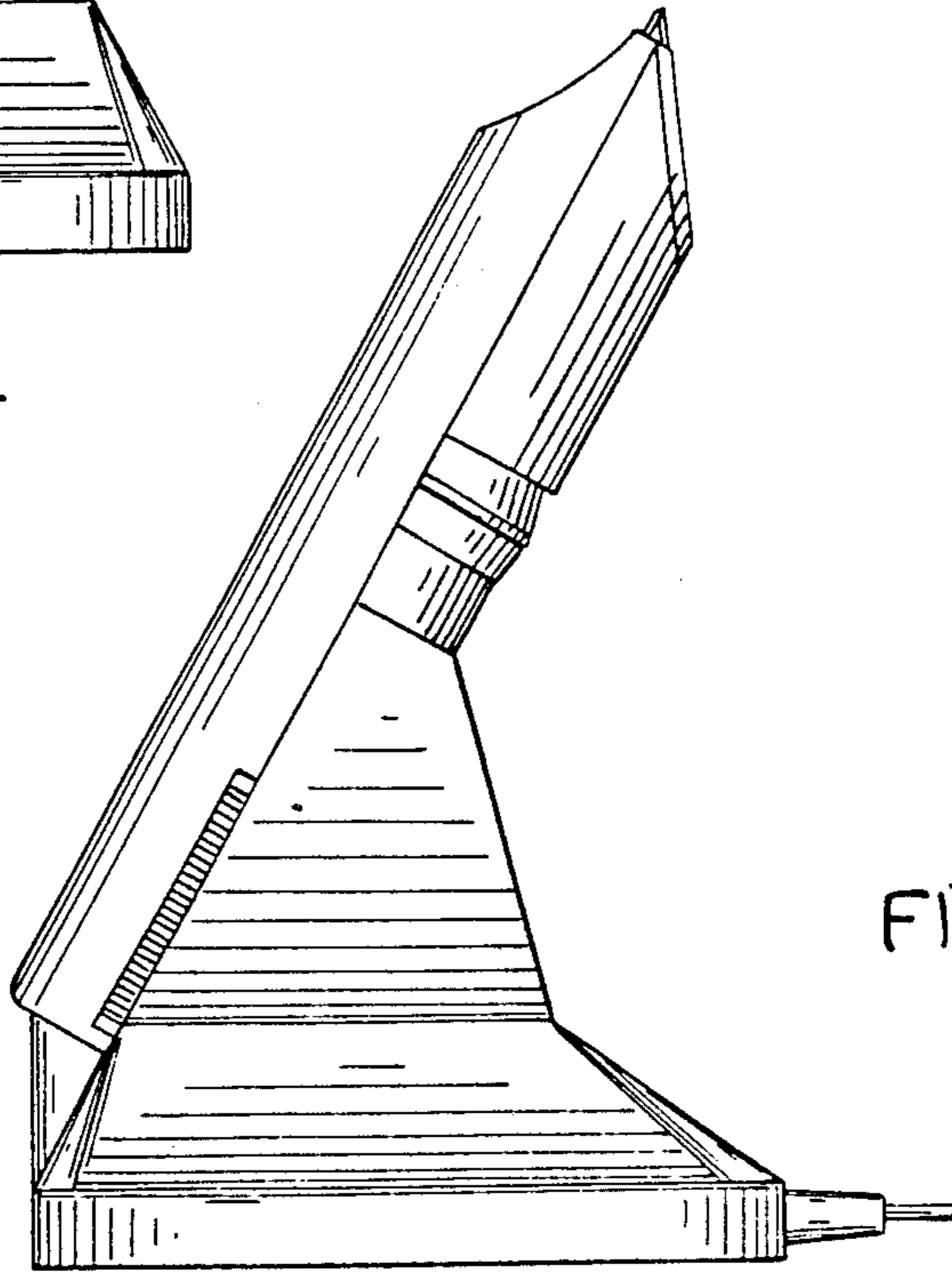

FIG. 6