

[54] SUNTAN LOTION APPLICATOR

[76] Inventors: Ernie A. Bacal, 99-637 Pohuli St., Aiea, Hi. 96701; George K. F. Lau, 1179 Olowalu Way, Honolulu, Hi. 96825; Randy W. Rock, 1720 Ala Moana Blvd., Apt. D-106, Honolulu, Hi. 96815

[**] Term: 14 Years

[21] Appl. No.: 264,507

[22] Filed: Oct. 28, 1988

[52] U.S. Cl. D28/7

[58] Field of Search D28/7, 63; 15/244.1, 15/159 R; 401/196, 183, 203, 261, 266; D4/111, 119, 127, 137, 138

[56] References Cited

U.S. PATENT DOCUMENTS

D. 197,107	12/1963	Forgue	D28/7
D. 247,212	2/1978	Welch	D28/63
D. 250,229	11/1978	Werner	D28/63
D. 252,219	6/1979	Peeples	D28/7
D. 265,255	6/1982	O'Neil	D28/7
D. 285,172	8/1986	Scuderi	D28/7
D. 299,558	1/1989	Robison	D28/7
1,153,409	9/1915	Wheeler	128/62 A
1,270,536	6/1918	Maher	15/244.4
2,736,913	3/1956	Mirth	15/122
3,017,649	1/1962	Racicot	15/105
3,568,237	3/1971	Rhodes	15/244
3,783,467	1/1974	Grossman	15/209
4,299,005	11/1981	Brown	15/244
4,381,766	5/1983	Avolio	128/62 R

4,396,028	8/1983	Waggoner	132/88.7
4,571,106	2/1986	Scuderi	401/209
4,615,066	10/1986	Colognori	15/244 R

OTHER PUBLICATIONS

Advertisement for "The Applicator", in May 3, 1988, National Enquirer.

Primary Examiner—B. J. Bullock
Assistant Examiner—Sandra Morris
Attorney, Agent, or Firm—Martin E. Hsia

[57] CLAIM

The ornamental design for a suntan lotion applicator, as shown and described.

DESCRIPTION

FIG. 1 is a perspective view of a suntan lotion applicator, showing our new design, with the cap shown closed;

FIG. 2 is a bottom plan view thereof;

FIG. 3 is a right side elevational view thereof;

FIG. 4 is a top plan view thereof;

FIG. 5 is a left side elevational view thereof;

FIG. 6 is a rear elevational view thereof;

FIG. 7 is a front elevational view thereof;

FIG. 8 is a perspective view of a second embodiment of the design of FIG. 1, with the cap shown removed;

FIG. 9 is a bottom plan view of FIG. 8;

FIG. 10 is a right side elevational view of FIG. 8;

FIG. 11 is a top plan view of FIG. 8;

FIG. 12 is a left side elevational view of FIG. 8;

FIG. 13 is a rear elevational view of FIG. 8;

FIG. 14 is a front elevational view of FIG. 8.

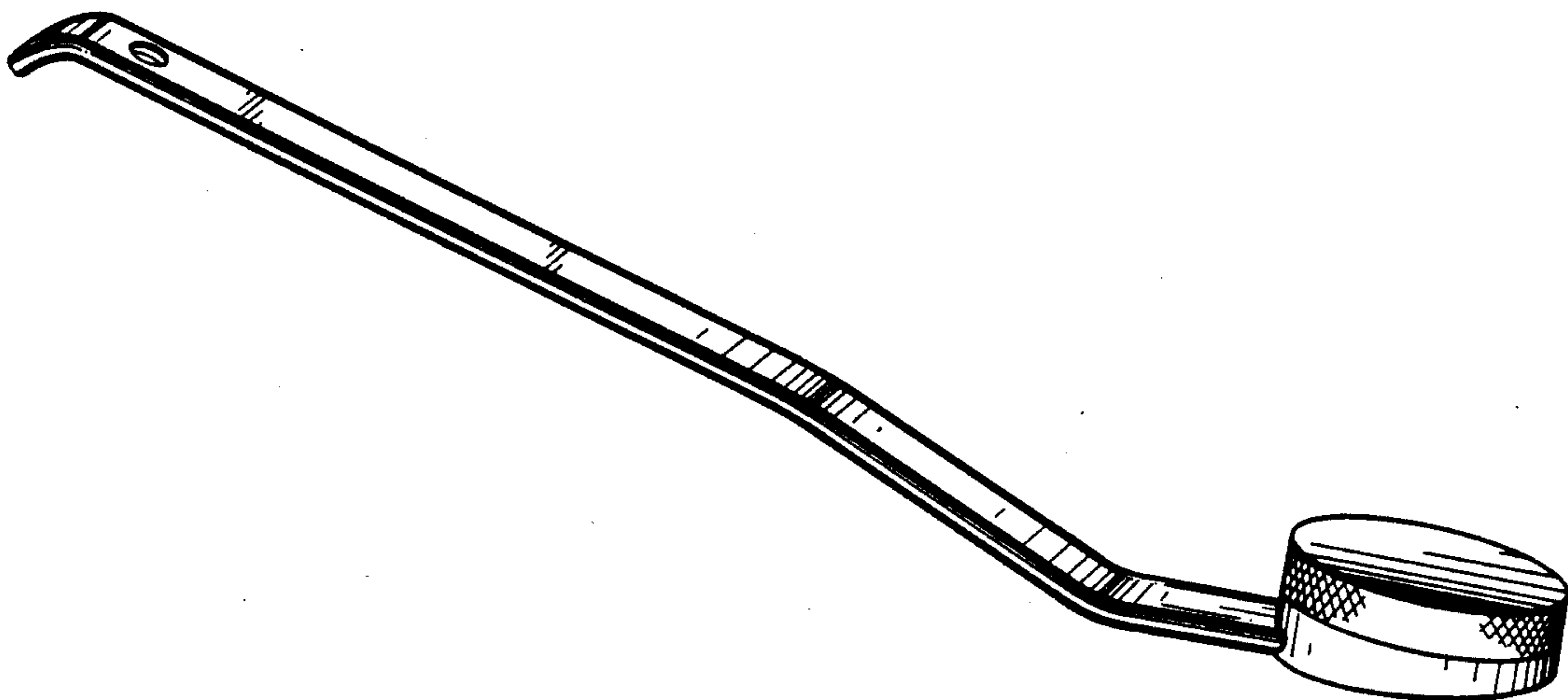

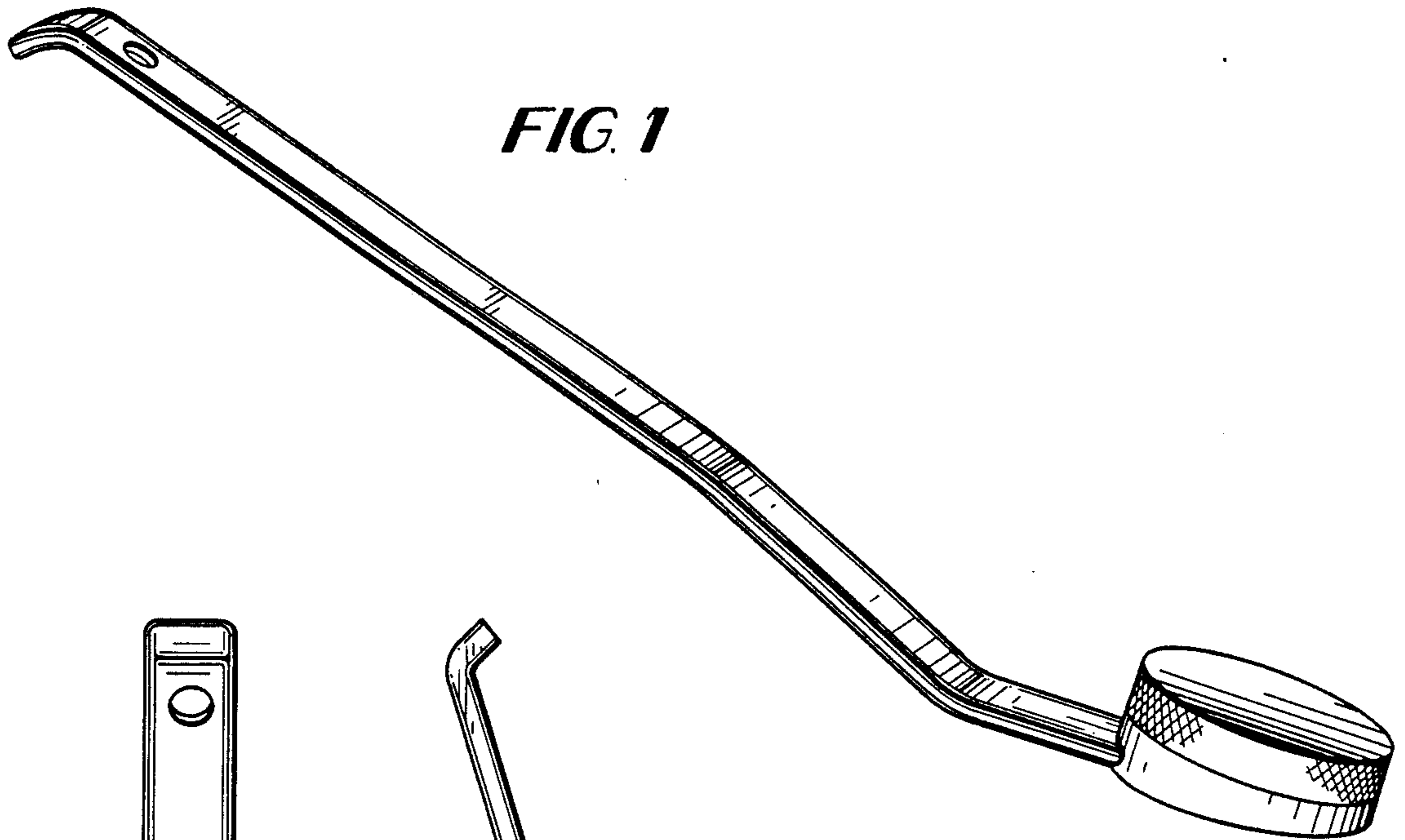

FIG. 1

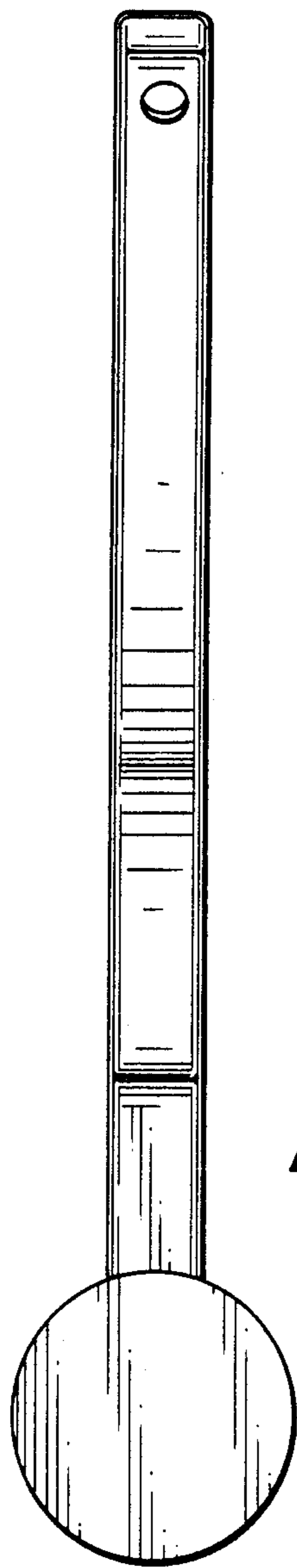

FIG. 2

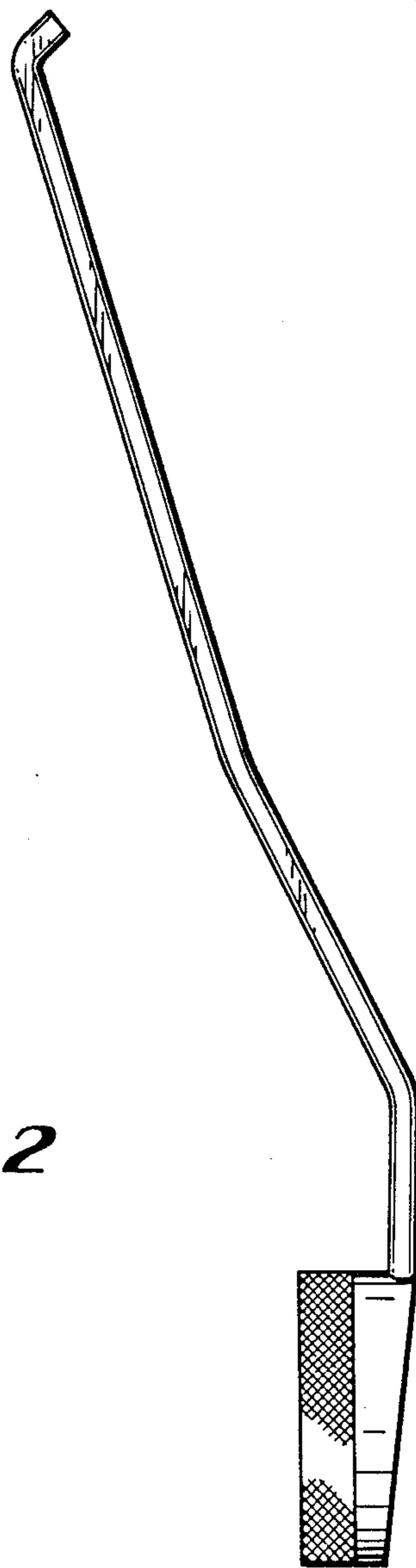

FIG. 3

FIG. 4

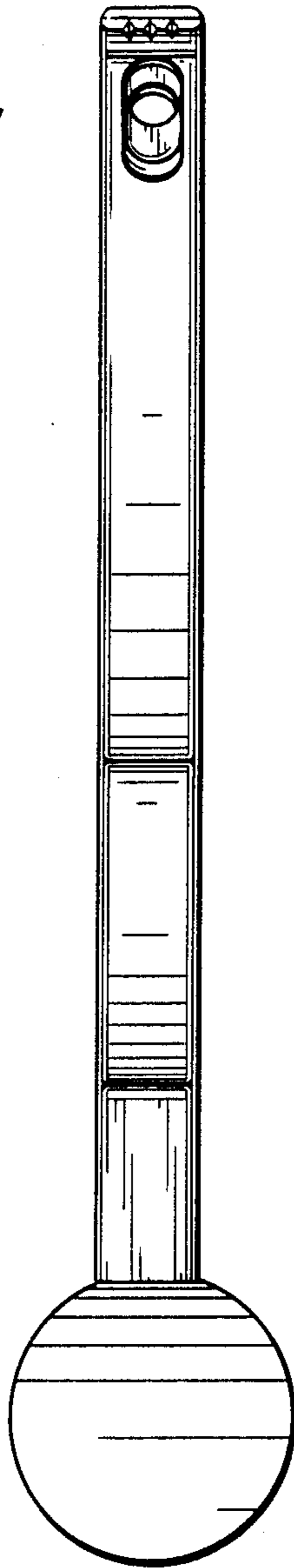

FIG. 5

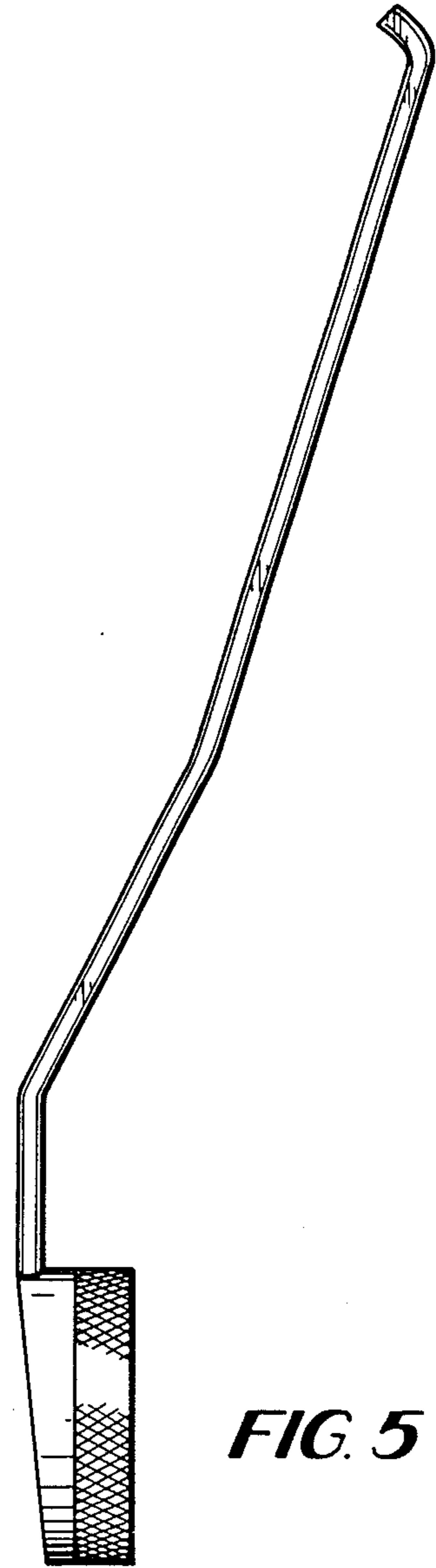

FIG. 6

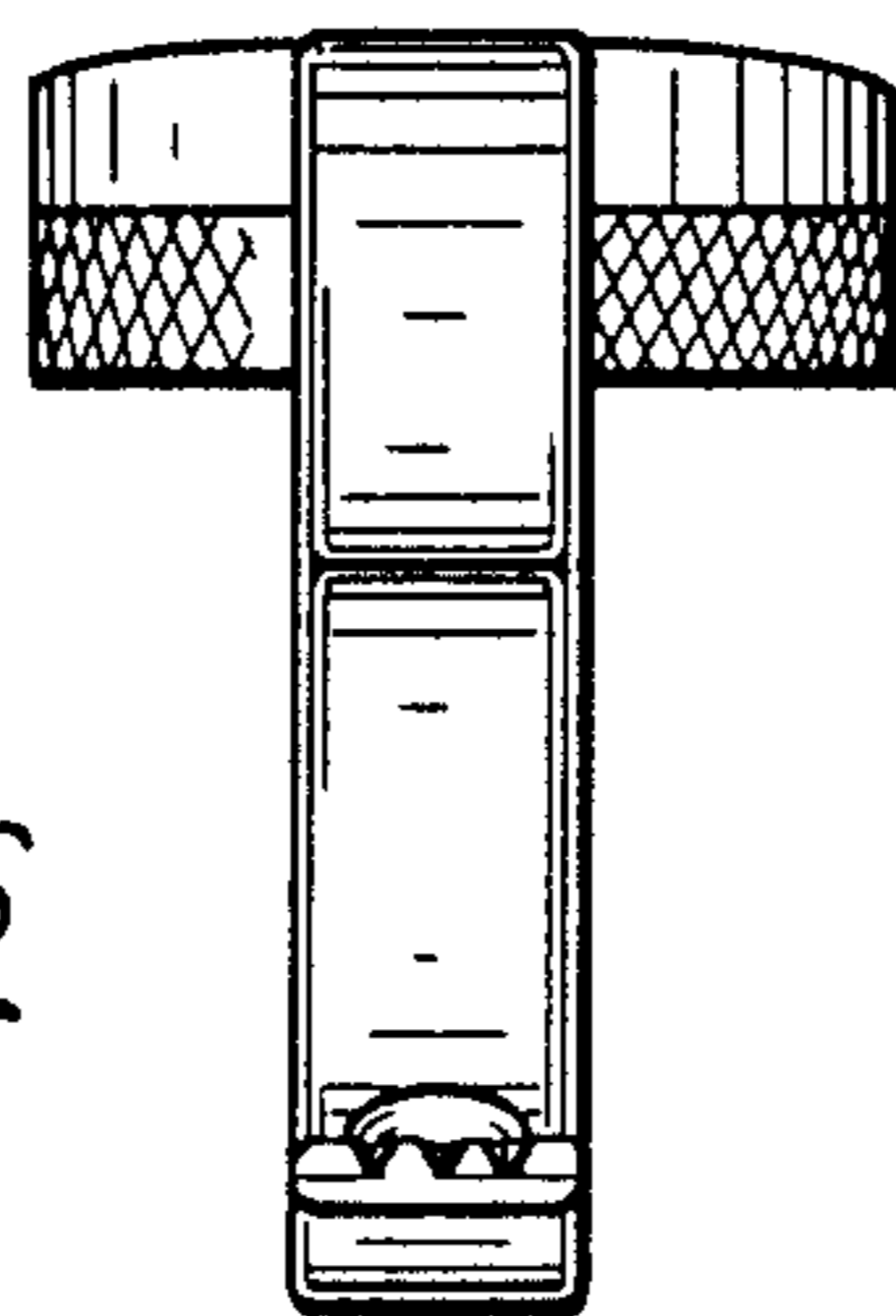
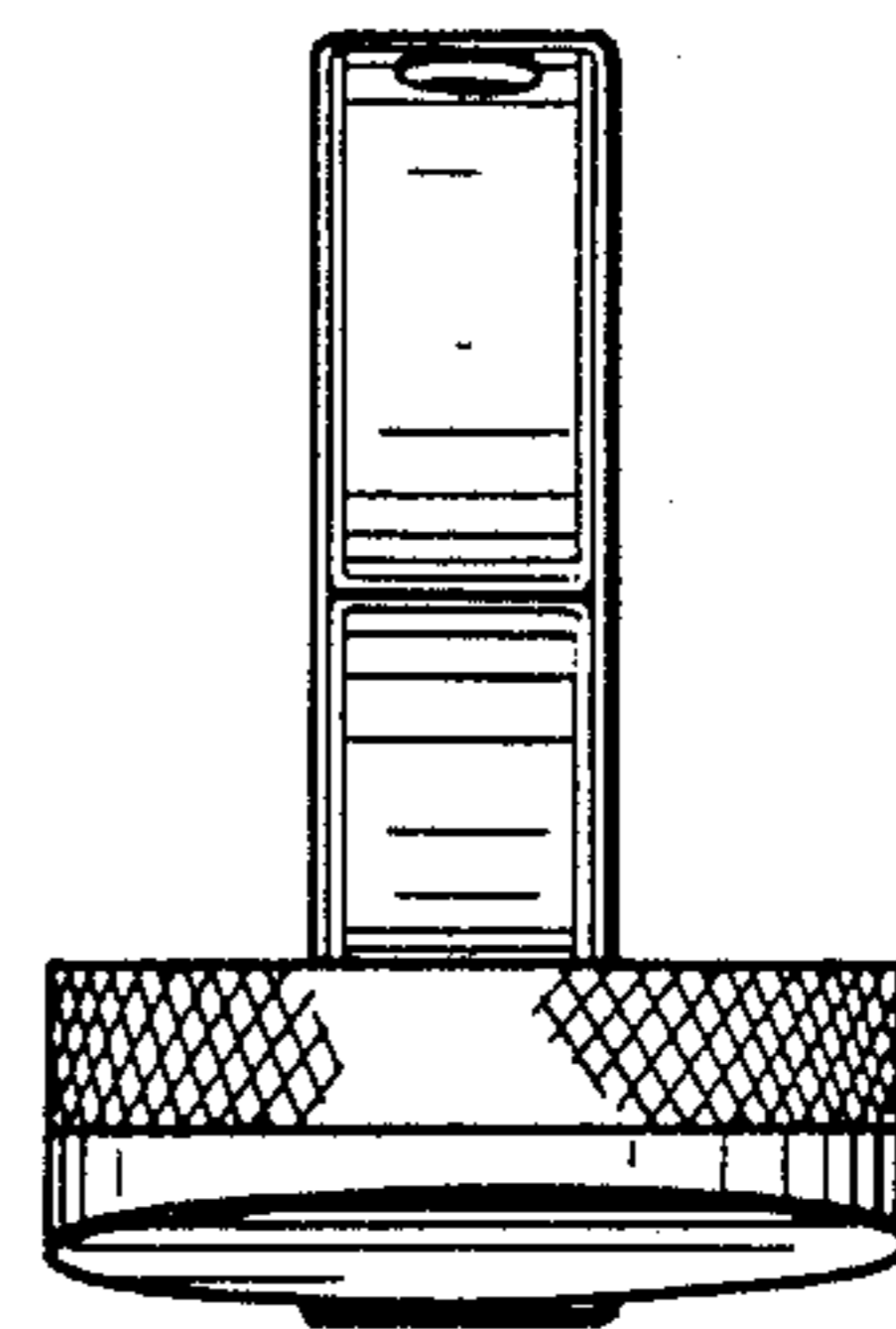

FIG. 7



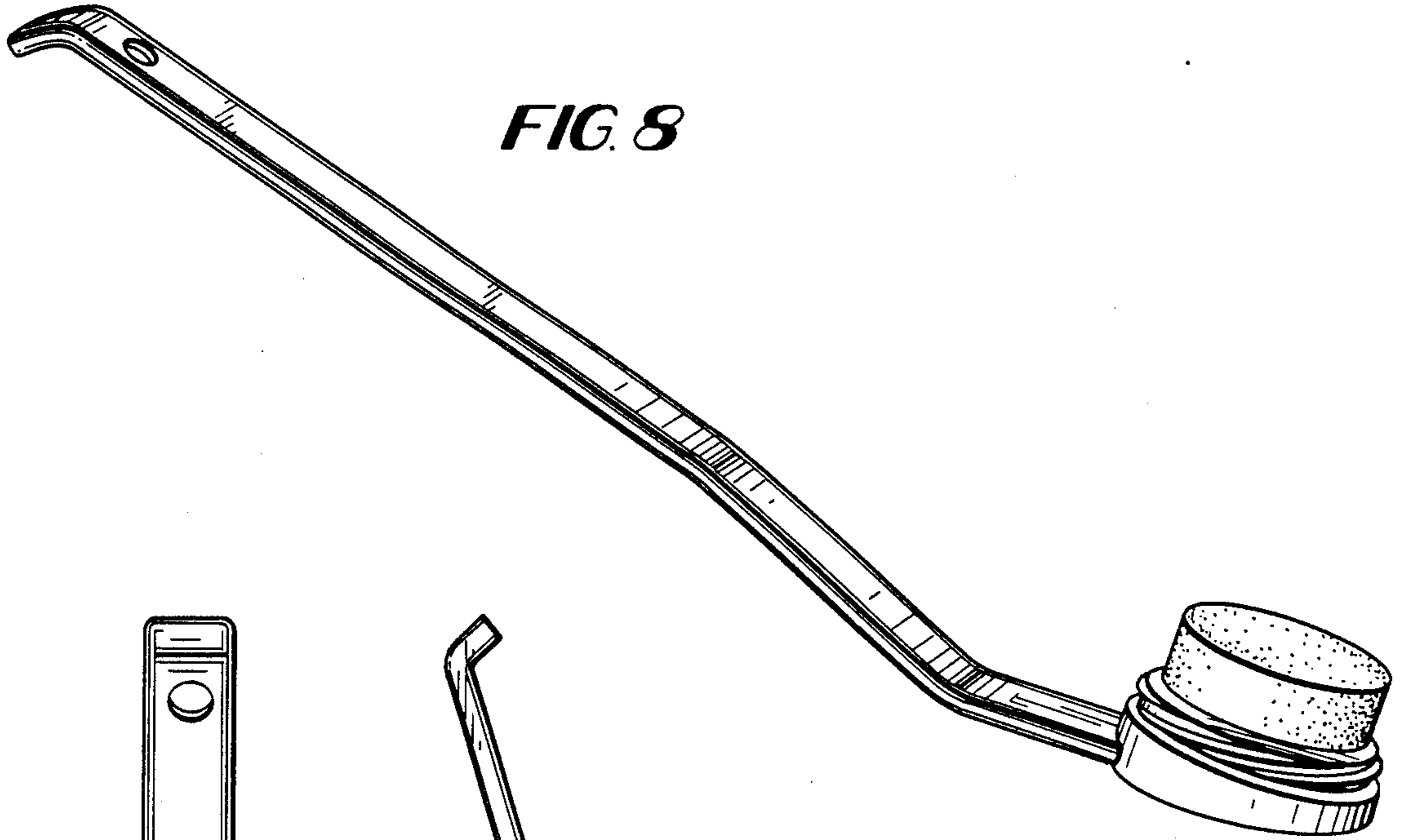

FIG. 8

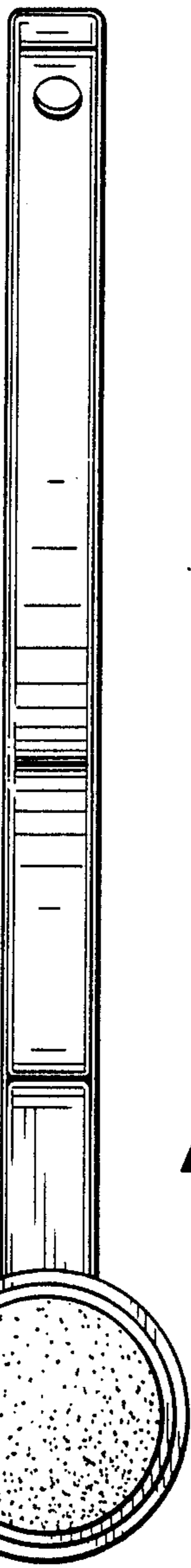

FIG. 9

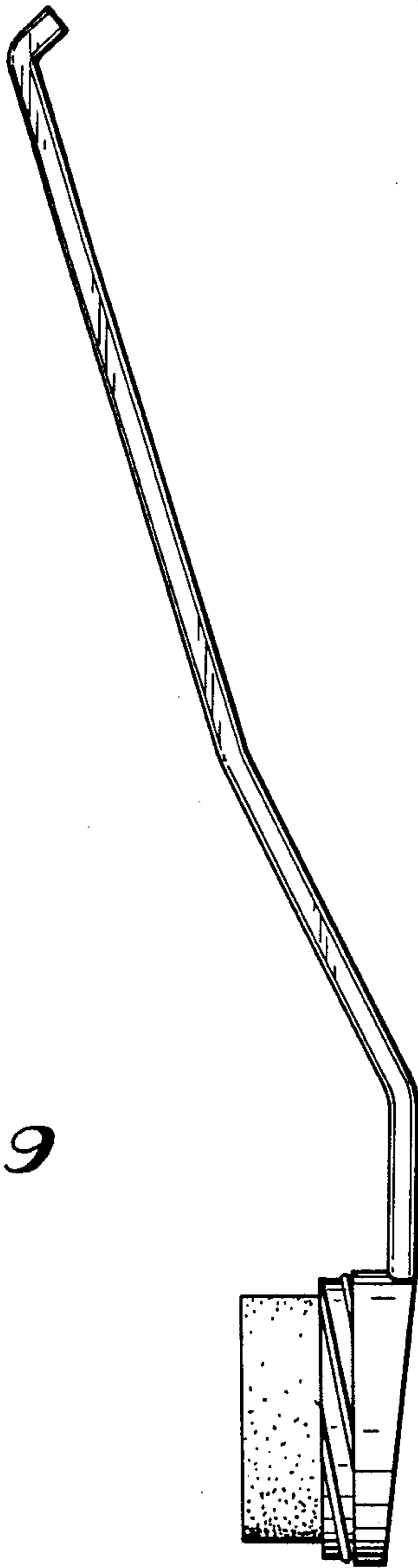

FIG. 10

FIG. 11

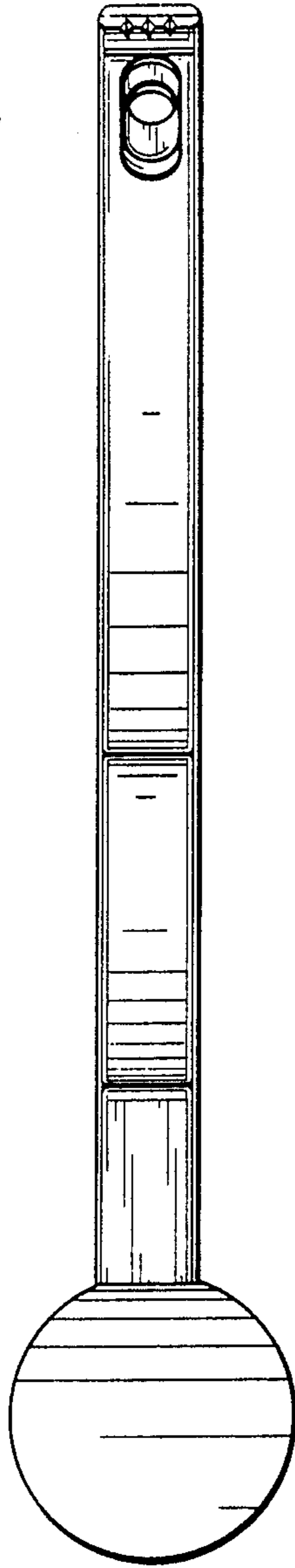

FIG. 12

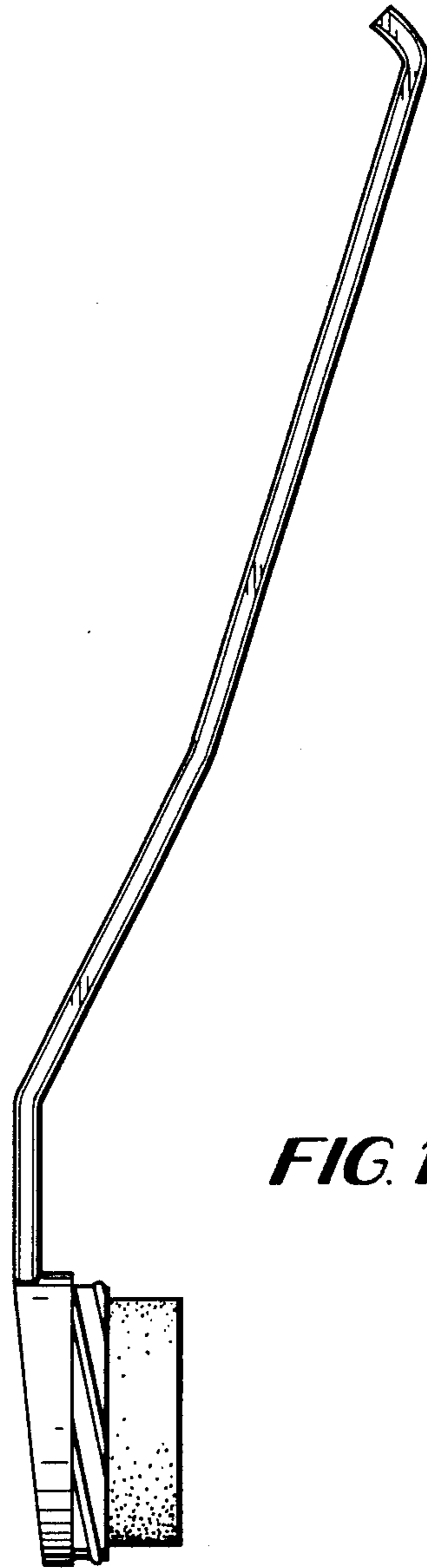

FIG. 13

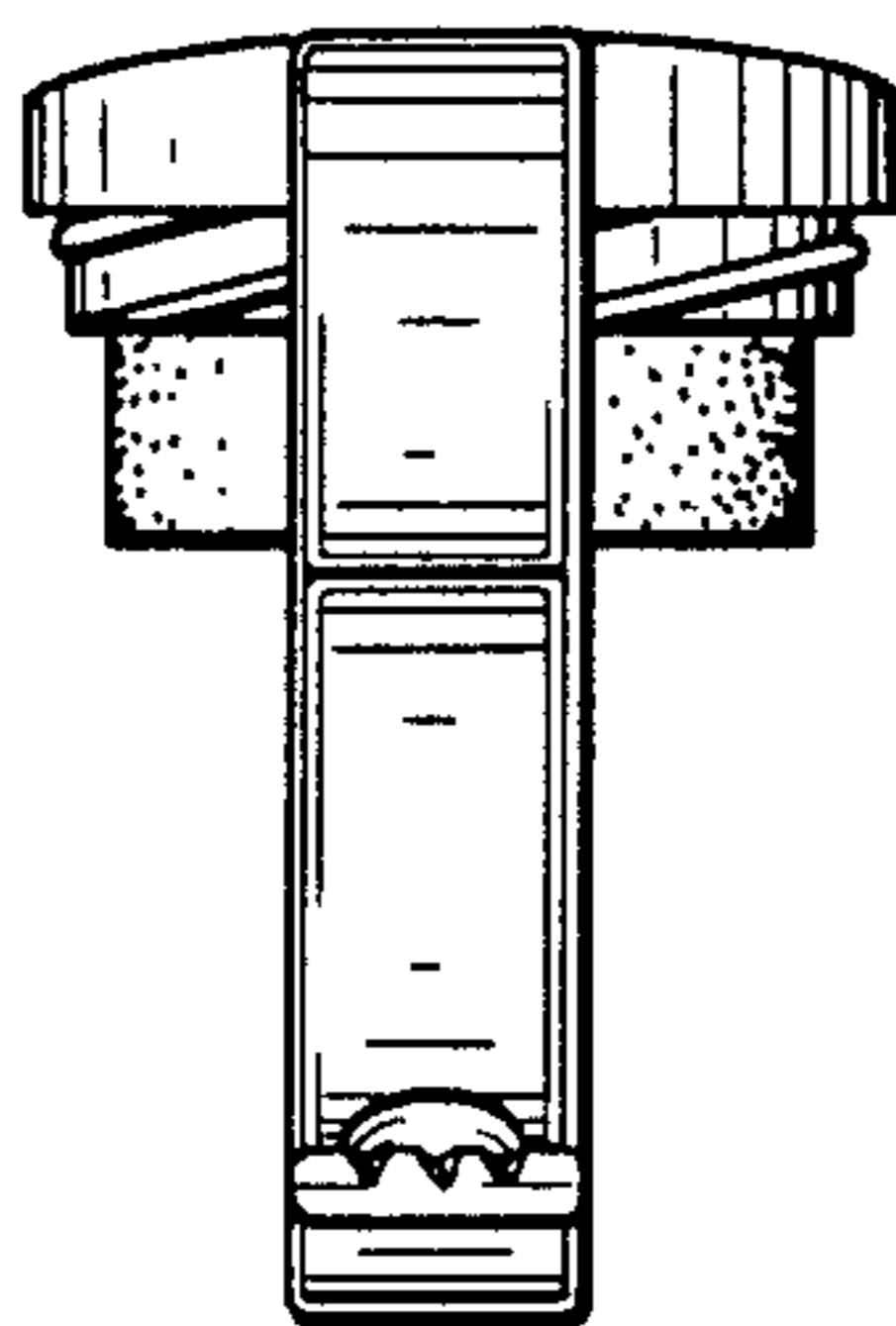

FIG. 14

