

[54] AUTOMOBILE LUGGAGE CARRIER SLAT

4,440,333	4/1984	Bott	224/324
4,516,710	7/1985	Bott	224/324
4,767,040	8/1988	Miller et al.	224/326
4,826,061	5/1989	Heideman	224/321

[76] Inventor: John A. Bott, 931 Lakeshore Dr., Grosse Pointe Shores, Mich. 48236

[**] Term: 14 Years

Primary Examiner—James M. Gandy
Assistant Examiner—Melody Brown
Attorney, Agent, or Firm—Harness, Dickey & Pierce

[21] Appl. No.: 200,782

[57] CLAIM

[22] Filed: Jun. 1, 1988

The ornamental design for an automobile luggage carrier slot, as shown and described.

[52] U.S. Cl. D12/157

[58] Field of Search D12/157; 224/309, 317, 224/321, 322, 324, 325, 326, 327

DESCRIPTION

[56] References Cited

U.S. PATENT DOCUMENTS

Re. 32,583	1/1988	Bott	224/326
3,615,069	10/1971	Bott	224/42.1 D
4,099,658	7/1978	Bott	224/42.1 F
4,106,680	8/1978	Bott	224/29 R
4,182,471	1/1980	Bott	224/326
4,222,508	9/1980	Bott	224/324
4,269,340	5/1981	Kowalski et al.	224/321
4,295,587	10/1981	Bott	224/321
4,427,141	1/1984	Bott	224/326
4,431,123	2/1984	Bott	224/321
4,432,478	2/1984	Bott	224/321

FIG. 1 is a perspective view of an automobile luggage carrier slat showing my new design, it being understood that the broken lines are for illustrative purposes only and form no part of the claimed design;

FIG. 2 is an enlarged perspective view thereof, which has been broken away in the middle for convenience of illustration;

FIG. 3 is an enlarged fragmentary top plan view thereof, the opposite end being a mirror image of that shown;

FIG. 4 is an end elevational view of FIG. 3;

FIG. 5 is a left side elevational view of FIG. 3; and

FIG. 6 is a right side elevational view of FIG. 3.

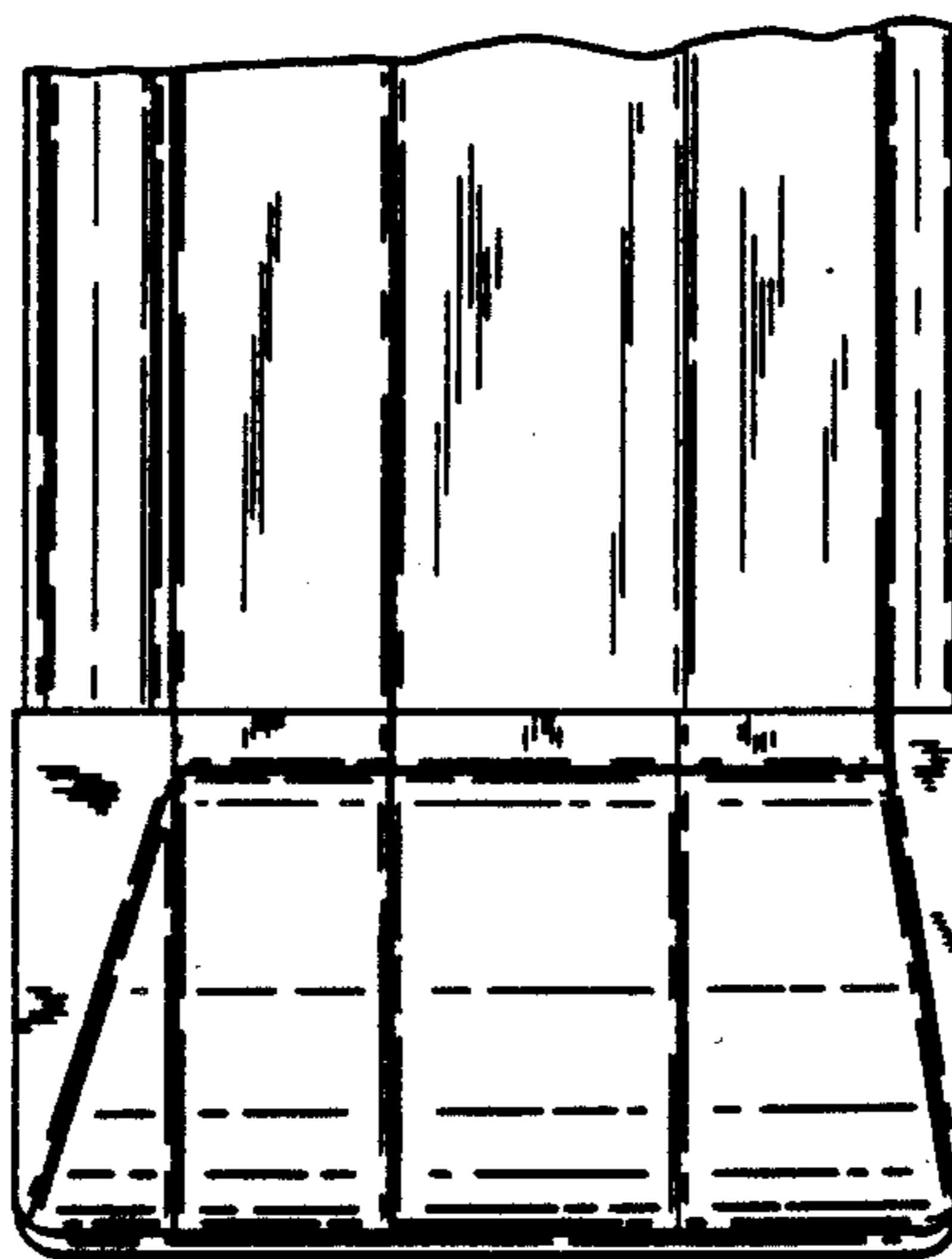
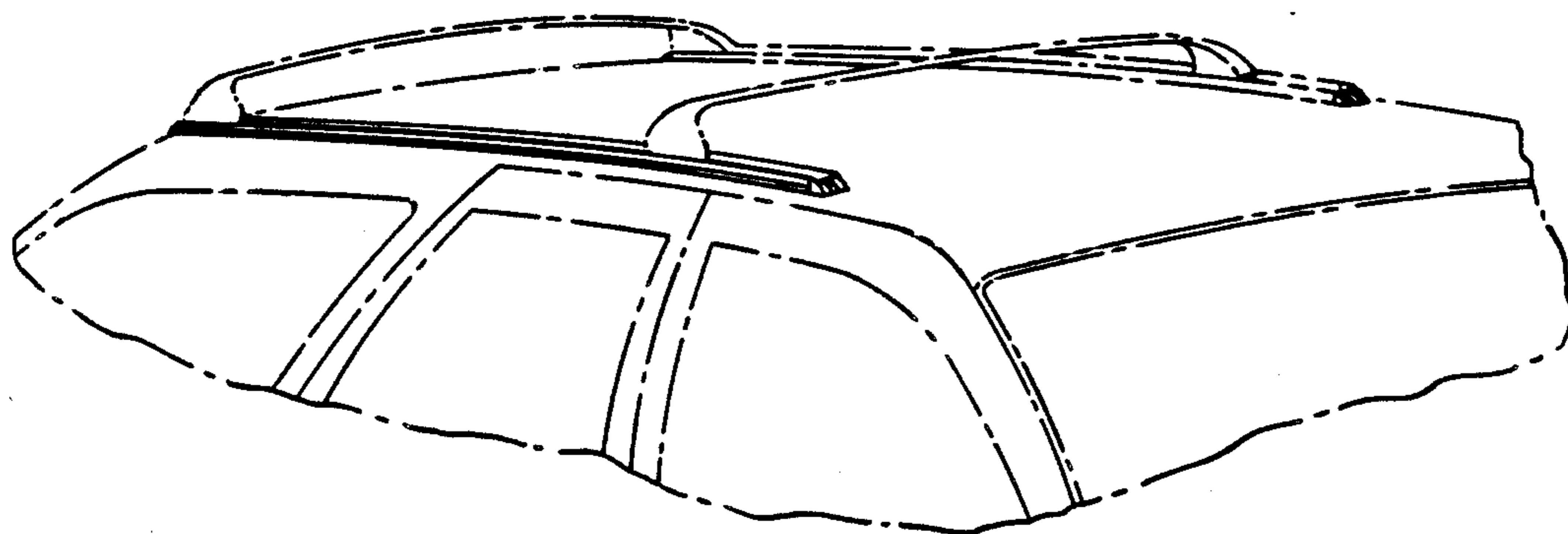

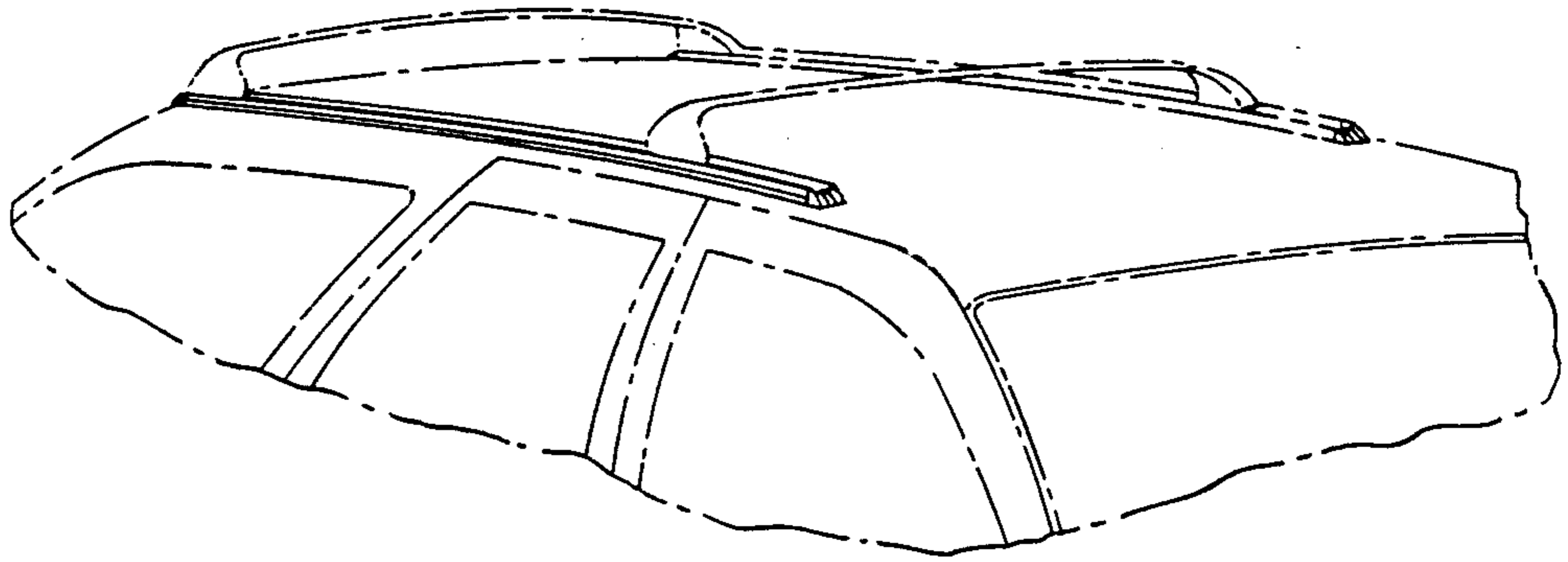

FIG. 1.

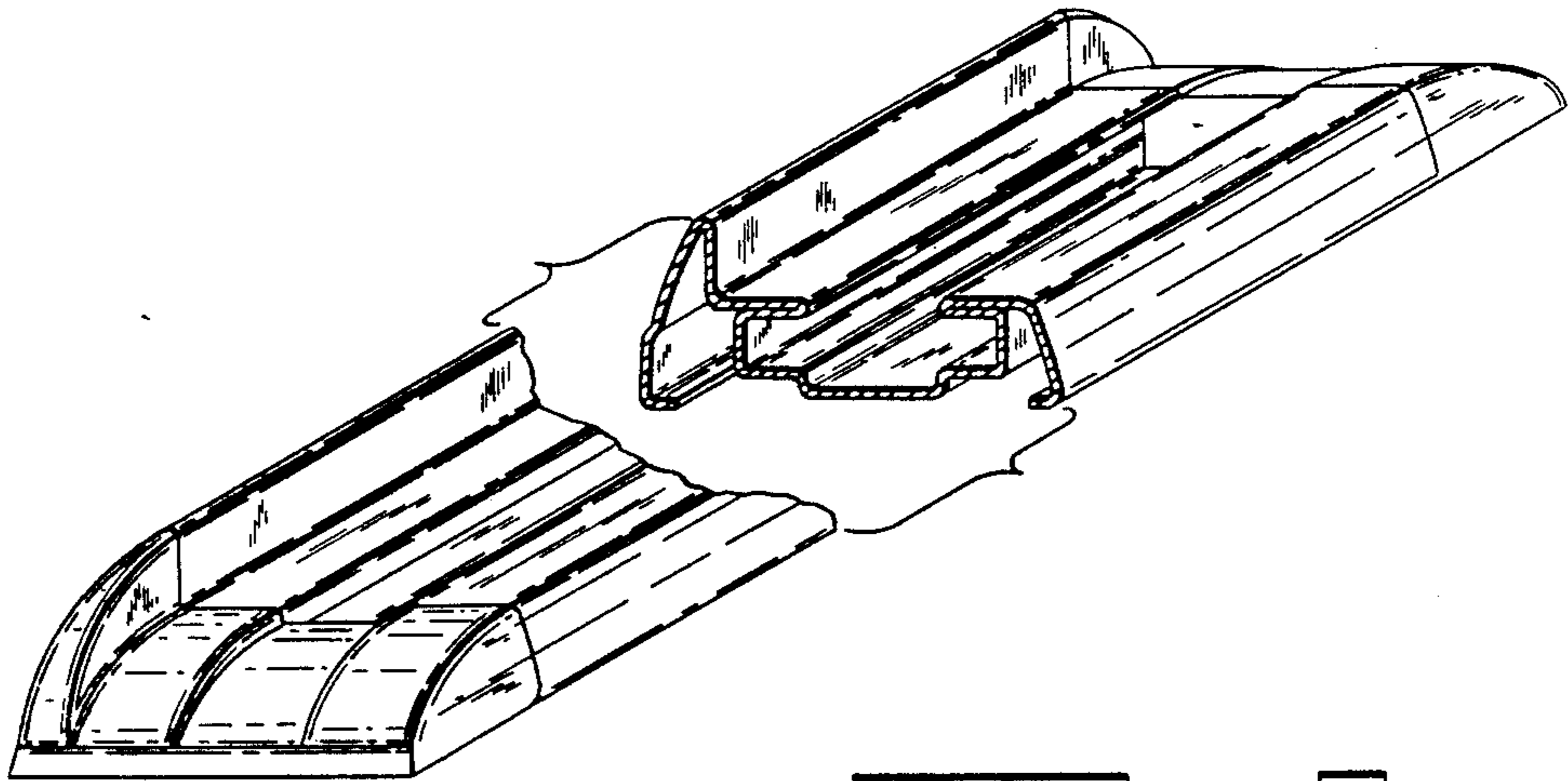

FIG. 2.

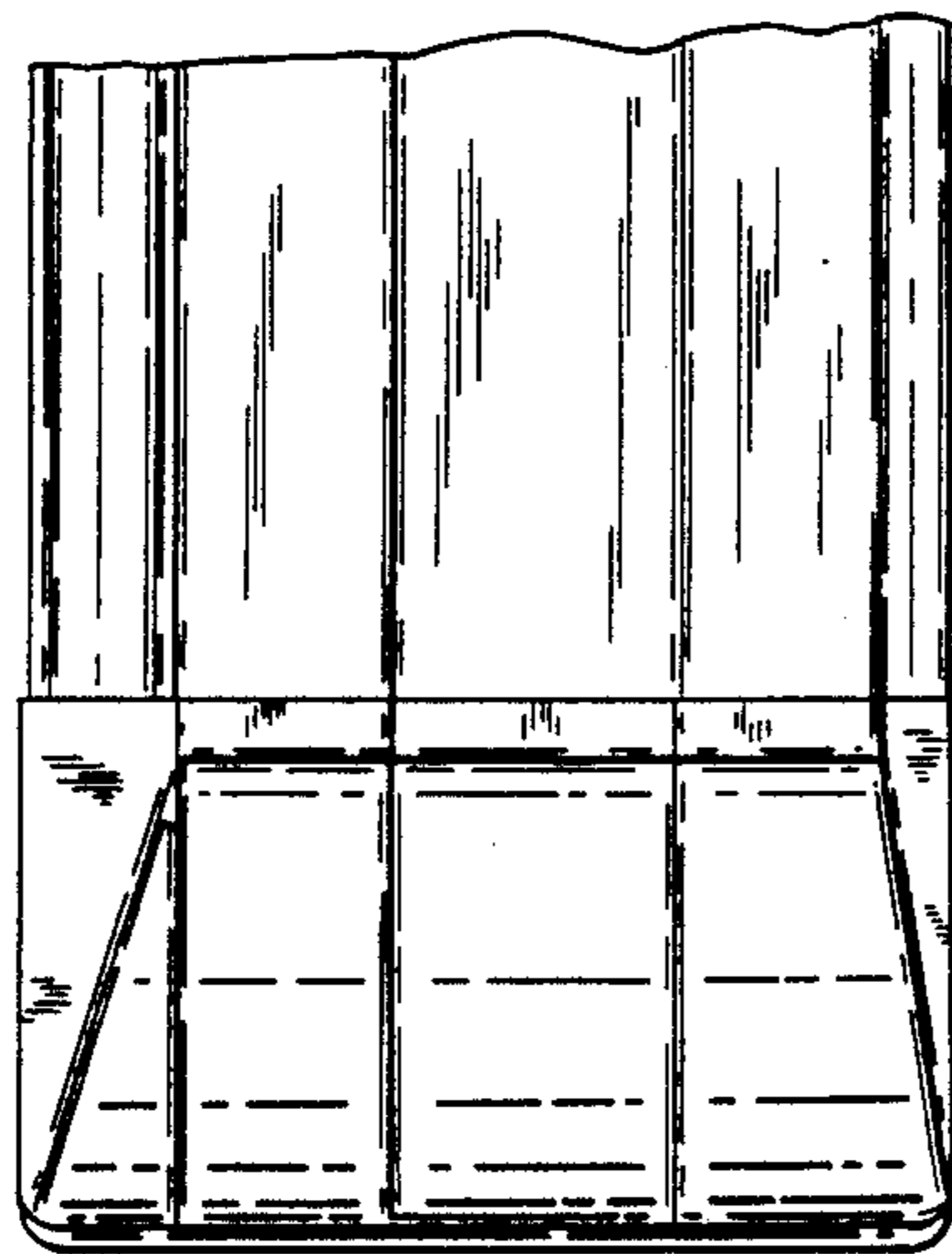

Fig. 3.



Fig. 4.

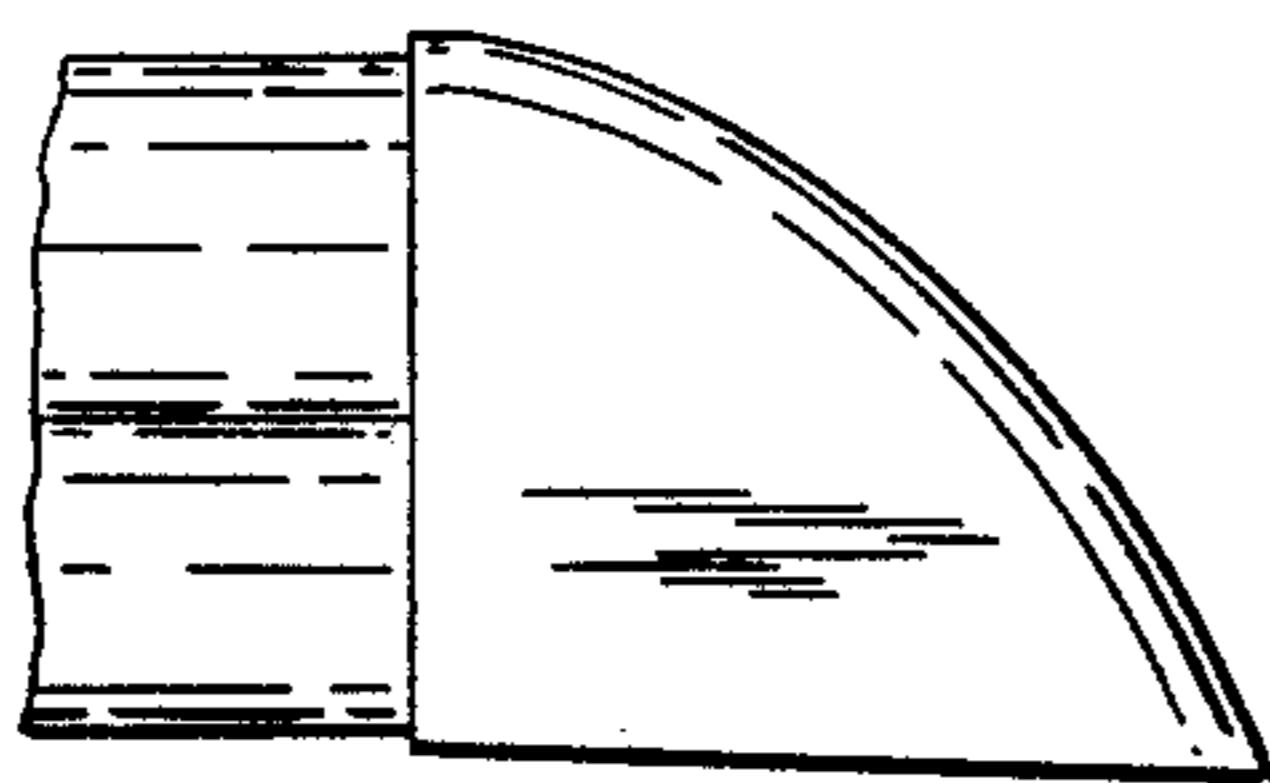

Fig. 5.

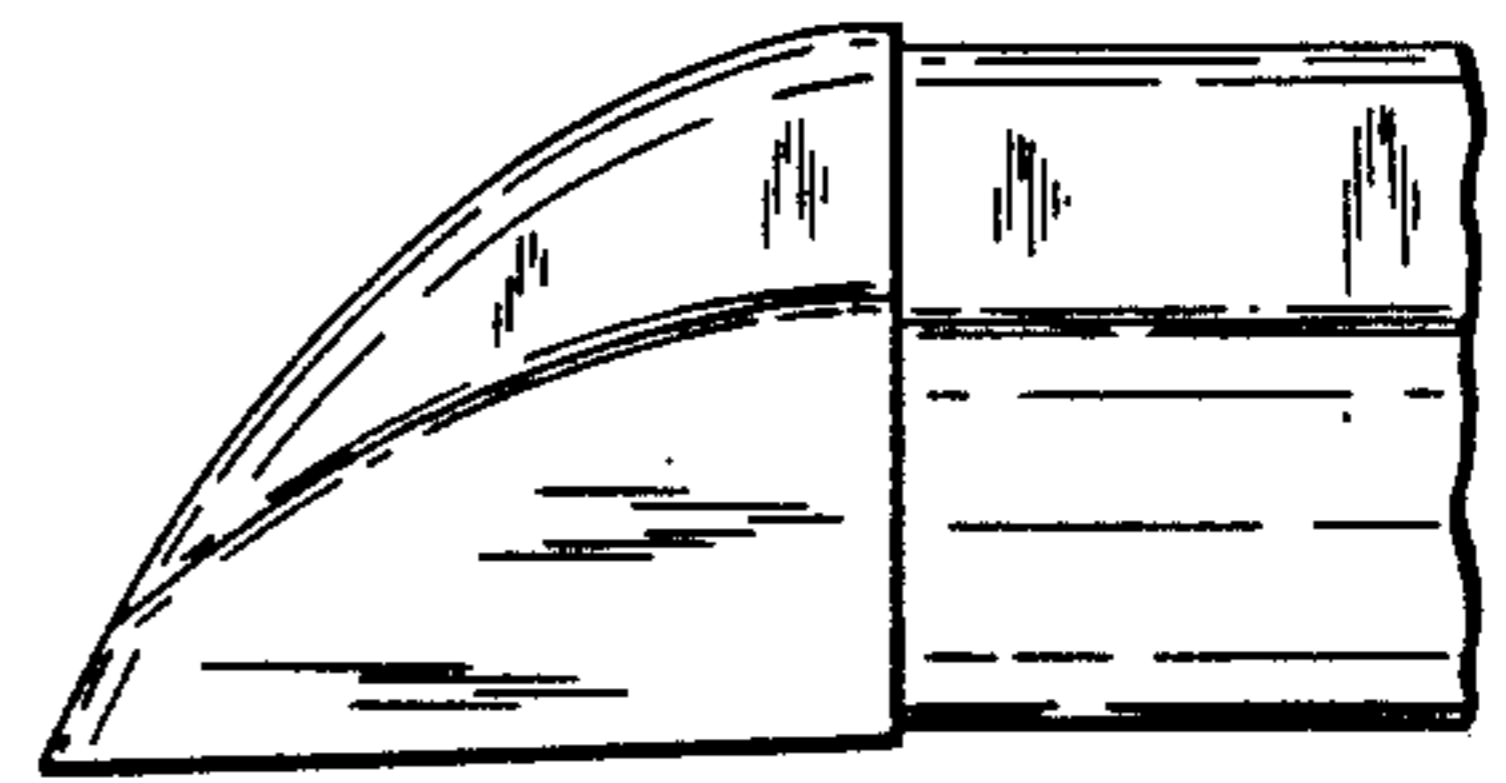

Fig. 6.