

[54] WALL MOUNTED BATHROOM ACCESSORY

[76] Inventor: Willard Aaron, P.O. Box 161, Glencoe, Ill. 60022

[\*\*] Term: 14 Years

[21] Appl. No.: 203,866

[22] Filed: Jun. 8, 1988

[52] U.S. CL. .... D6/524; D6/549; D6/567; D6/574

[58] Field of Search ..... D6/512, 518, 523, 524, D6/527-528, 531, 532, 534-535, 536, 540, 546, 548-549, 553, 567, 574; 108/27-28, 149; 211/16, 87-88, 90, 105.1-105.2, 123, 134

[56] References Cited

U.S. PATENT DOCUMENTS

D. 114,111	4/1939	Zimmer	.....	D6/549
D. 236,864	9/1975	Tegner	.....	D6/549
D. 267,527	1/1983	Cohen	.....	D6/540
D. 267,528	1/1983	Cohen	.....	D6/531
D. 267,603	1/1983	Cohen	.....	D6/540
D. 267,840	2/1983	Cohen	.....	D6/549
D. 270,503	9/1983	Cohen	.....	D6/546
D. 274,486	7/1984	Thompson	.....	D6/540 X
D. 278,586	4/1985	Thompson	.....	D6/531
D. 283,188	4/1986	Pool	.....	D6/523
D. 289,255	4/1987	Chasen	.....	D6/553 X
D. 291,518	8/1987	Chap	.....	D6/523
D. 291,519	8/1987	Chap	.....	D6/531
D. 291,638	9/1987	Chap	.....	D6/540
D. 291,753	9/1987	Pool	.....	D6/549 X
D. 294,906	3/1988	Pool	.....	D6/531
D. 294,907	3/1988	Pool	.....	D6/546
D. 295,805	5/1988	Stocker	.....	D6/518 X
D. 299,095	12/1988	Gresons et al.	.....	D6/524
D. 301,955	7/1989	Joss et al.	.....	D6/546
D. 302,222	7/1989	Joss et al.	.....	D6/523

OTHER PUBLICATIONS

Bloomington's Catalogue (Jun. 1981), p. 42, "Plastic Ring-A-Rounds".  
 Domus, 5/1988, p. 14, -Bathroom Accessories.  
 Abitare, 3/1981, p. 122-Bathroom Accessories.  
 Fairfacts Co. advertisement-Bathroom Accessories.

Primary Examiner—Wallace R. Burke  
 Assistant Examiner—Brian N. Vinson  
 Attorney, Agent, or Firm—Richard J. Myers

[57] CLAIM

The ornamental design for a wall mounted bathroom accessory, as shown and described.

DESCRIPTION

FIG. 1 is a top plan view of a wall mounted bathroom accessory showing my new design as embodied in a towel rack, the bottom being a mirror image of that shown;  
 FIG. 2 is a front elevational view thereof;  
 FIG. 3 is a rear elevational view thereof;  
 FIG. 4 is a right side elevational view thereof, the left side being a mirror image of that shown;  
 FIG. 5 is a top plan view of a wall mounted bathroom accessory showing my new design as embodied in a shelf, the bottom being plain and unornamented;  
 FIG. 6 is a front elevational view thereof;  
 FIG. 7 is a rear elevational view thereof;  
 FIG. 8 is a right side elevational view thereof, the left side being a mirror image of that shown;  
 FIG. 9 is a top plan view of a wall mounted bathroom accessory showing my new design as embodied in a towel rack, the bottom being a mirror image of that shown;  
 FIG. 10 is a front elevational view thereof;  
 FIG. 11 is a rear elevational view thereof;  
 FIG. 12 is a right side elevational view thereof, the left side being a mirror image of that shown; and  
 FIG. 13 is a top, front, and left side perspective view thereof.

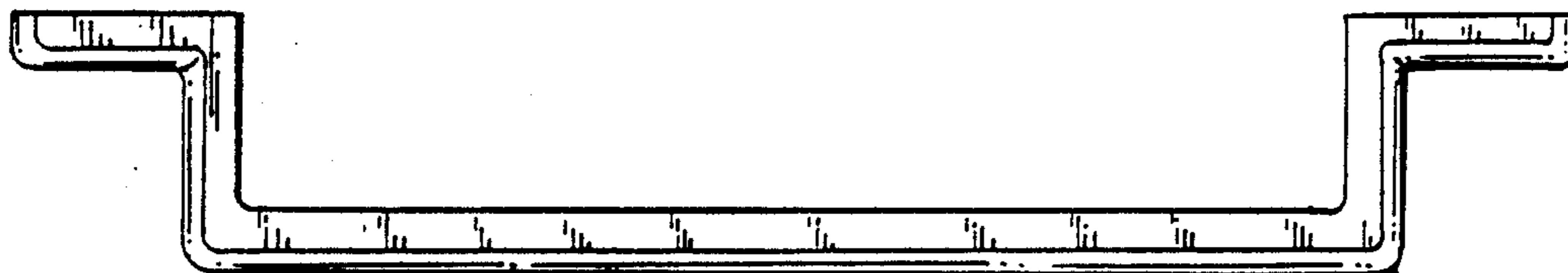

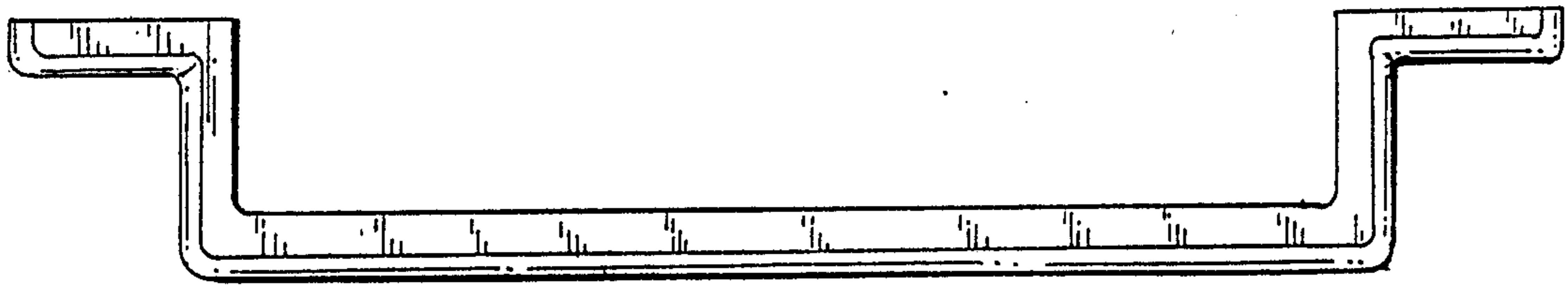

FIG. 1

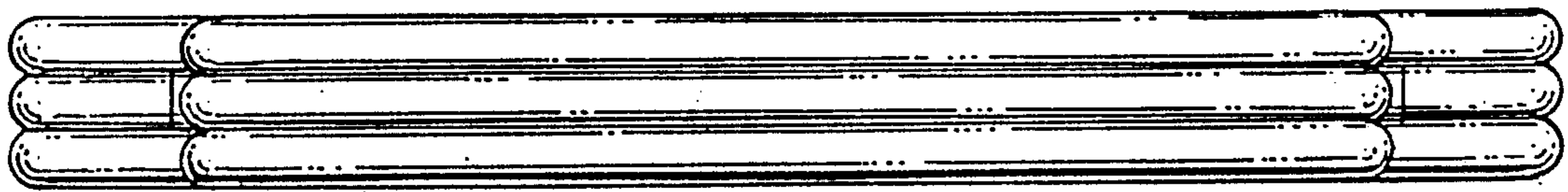

FIG. 2

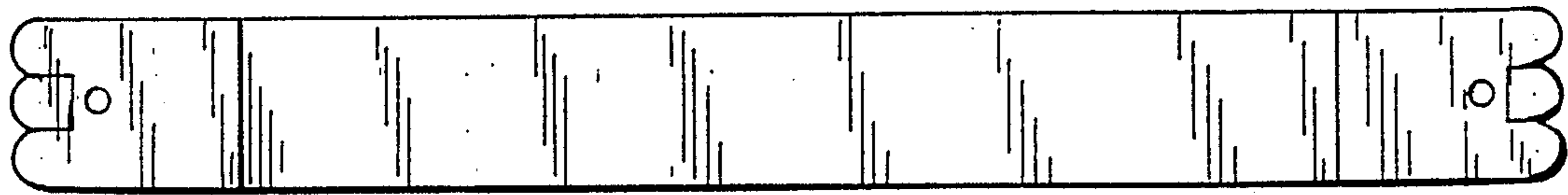

FIG. 3

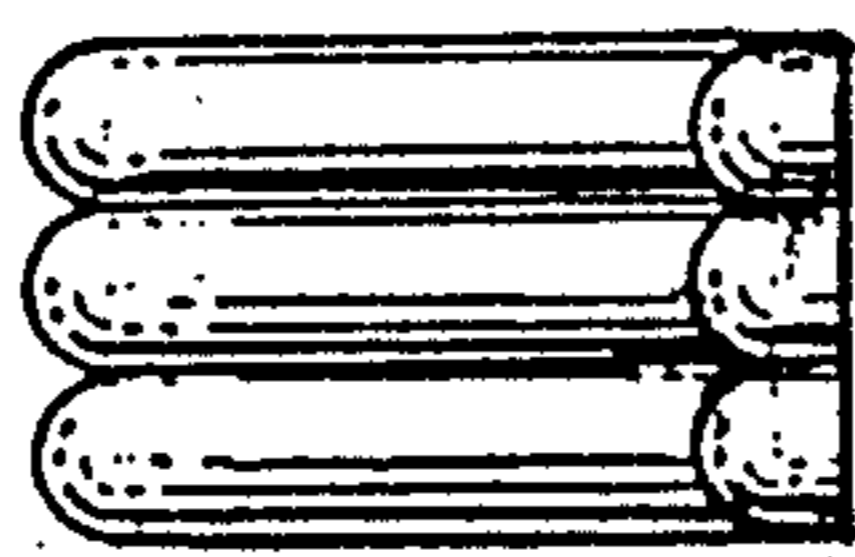

FIG. 4

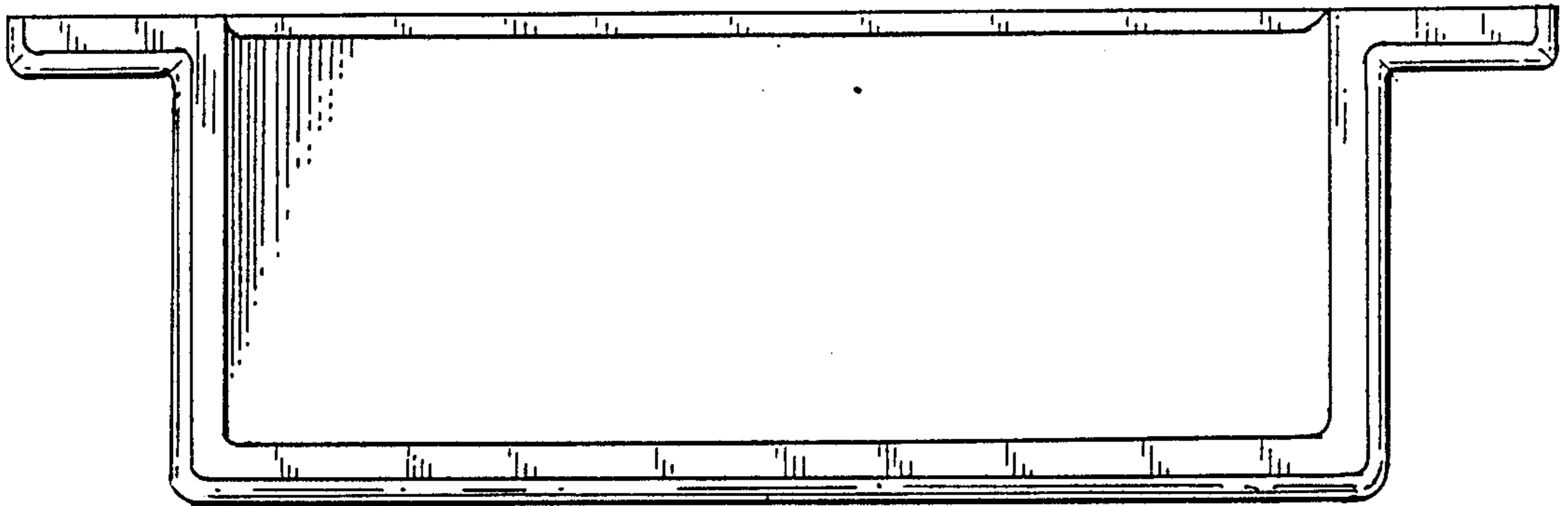

FIG. 5

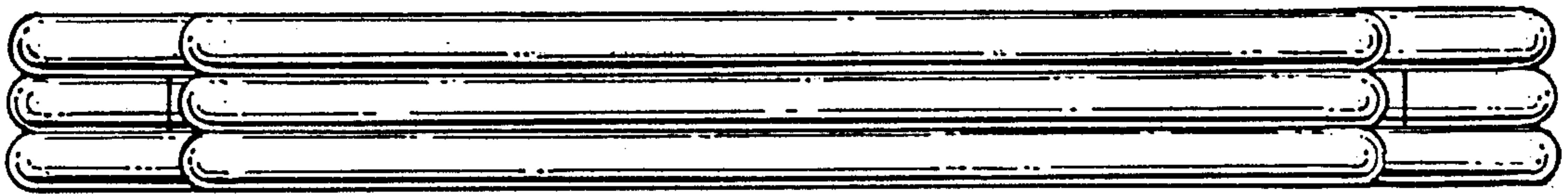

FIG. 6

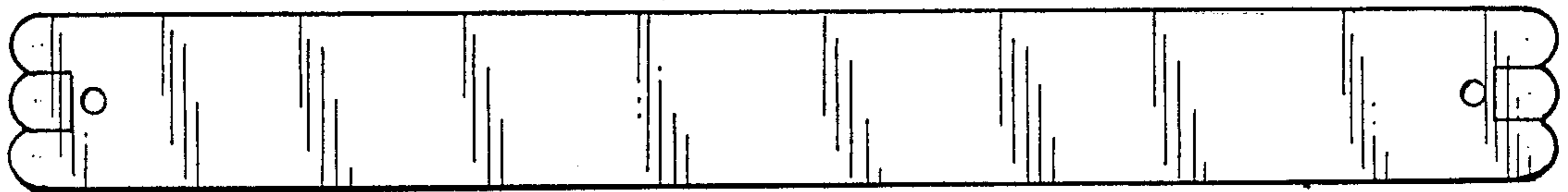

FIG. 7

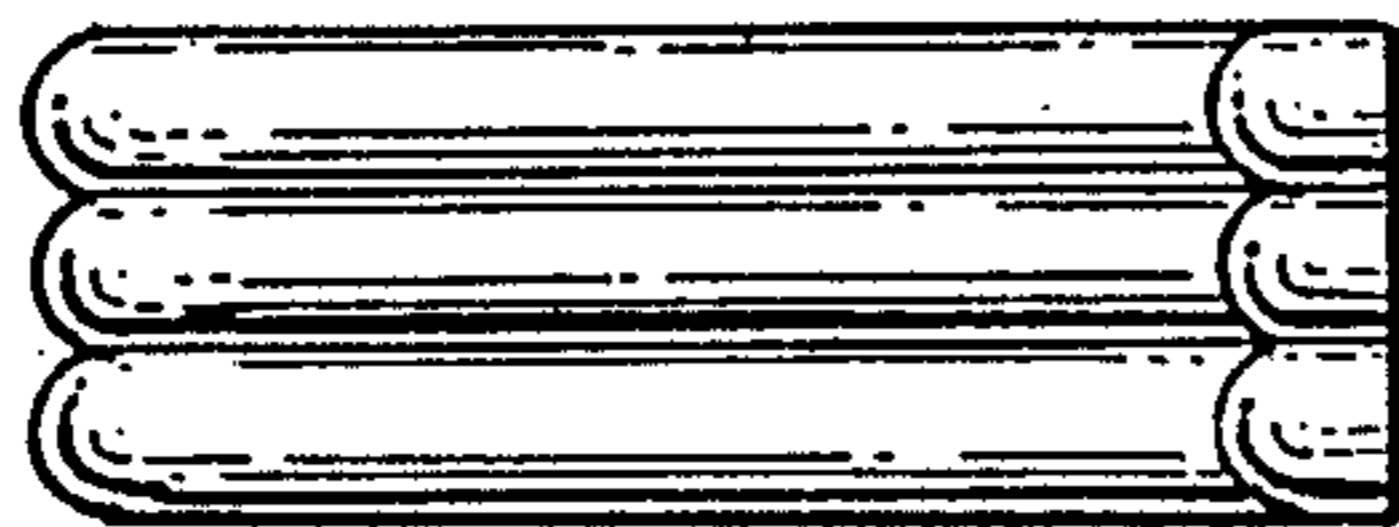

FIG. 8

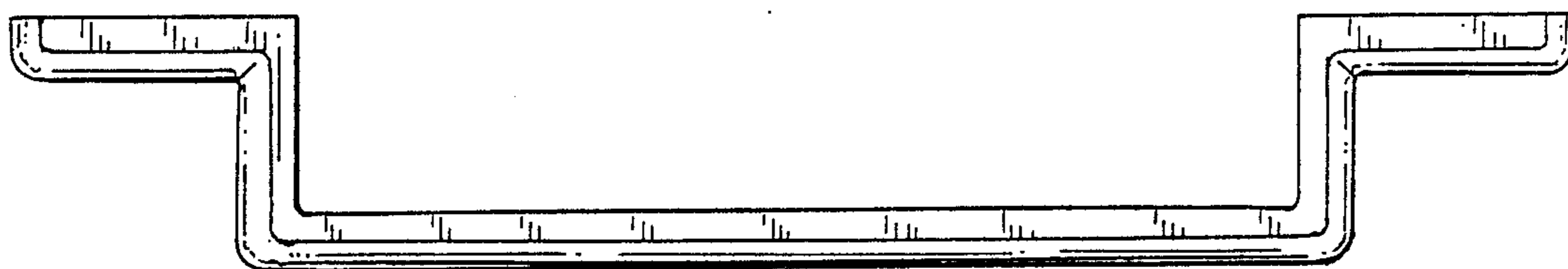

FIG. 9

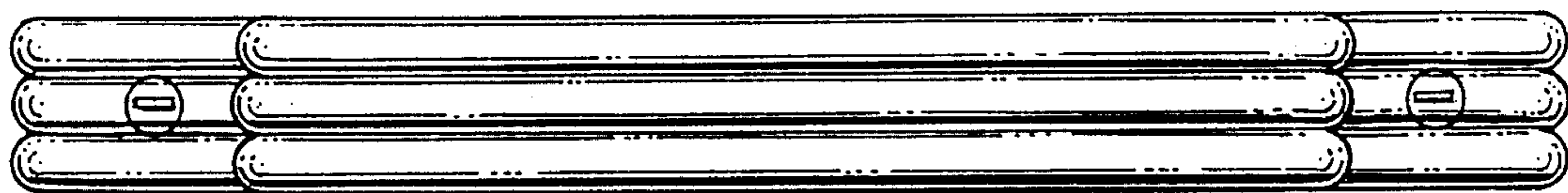

FIG. 10

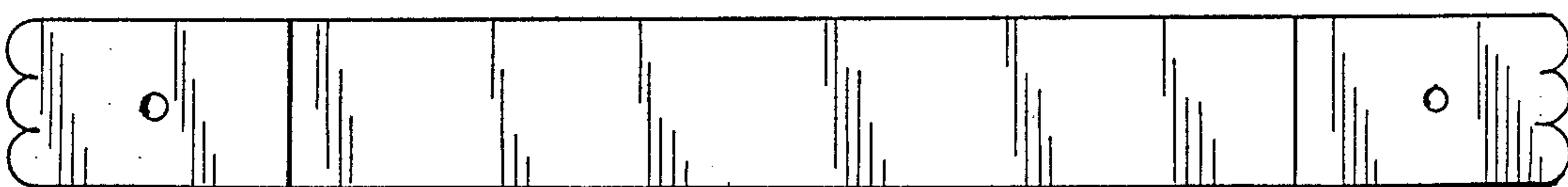

FIG. 11

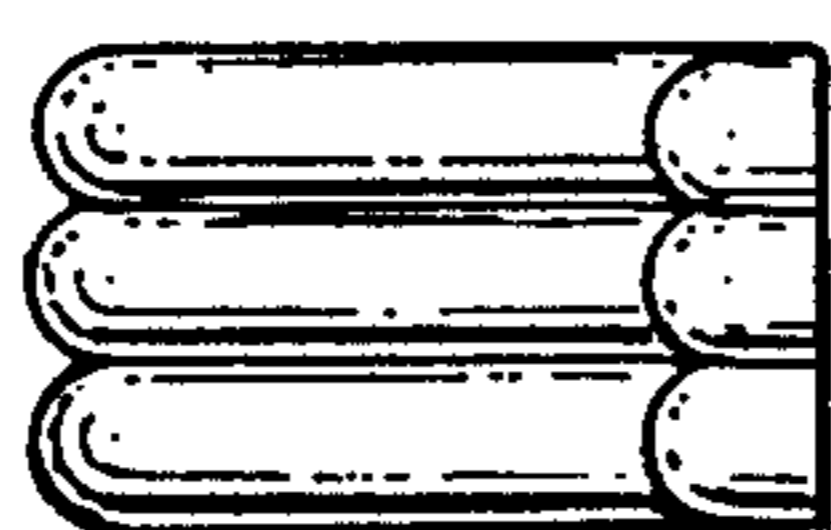

FIG. 12

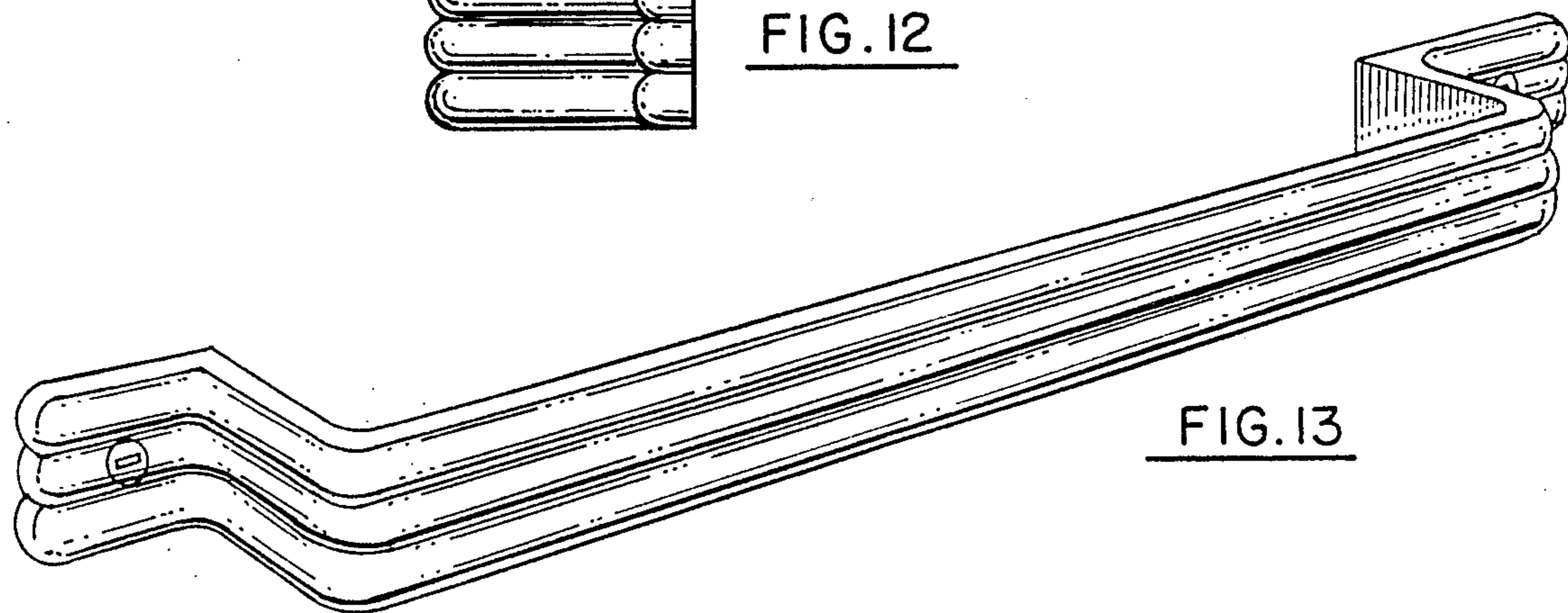

FIG. 13