

[54] TOILET

[75] Inventors: Herbert V. Kohler, Jr., Kohler; Mary J. Reid, Sheboygan, both of Wis.

[73] Assignee: Kohler Co., Kohler, Wis.

[**] Term: 14 Years

[21] Appl. No.: 144,433

[22] Filed: Jan. 12, 1988

[52] U.S. Cl. D23/301

[58] Field of Search D23/295-301, D23/309, 313; 4/306, 329-332, 353, 420-448, DIG. 15

[56] References Cited

U.S. PATENT DOCUMENTS

| | | | | |
|------------|---------|--------------|-------|---------|
| D. 188,750 | 9/1960 | Swann | | D23/301 |
| D. 250,202 | 11/1978 | Doman et al. | | D23/301 |
| D. 256,609 | 8/1980 | Primault | | D23/295 |
| D. 258,680 | 3/1981 | Wilson | . | |
| D. 258,681 | 3/1981 | Wilson | . | |
| D. 261,797 | 11/1981 | Kaiser | | D23/295 |
| D. 261,799 | 11/1981 | Alger | . | |
| D. 268,780 | 4/1983 | Doman et al. | | D23/301 |
| D. 271,326 | 11/1983 | Doman et al. | | D23/301 |
| D. 274,747 | 7/1984 | Kaiser | | D23/295 |
| D. 284,303 | 6/1986 | Yuptot | | D23/301 |

| | | | | |
|------------|--------|-------------|-------|---------|
| D. 288,587 | 3/1987 | Stairs, Jr. | | D23/295 |
| D. 288,588 | 3/1987 | Stairs, Jr. | | D23/295 |

OTHER PUBLICATIONS

- P. 2 of a 1982 Ideal Standard ad showing the Pierre Cardin fixtures.
- P. 14 of a brochure showing the "Galleria" toilet, undated.
- Ceramica ad for Europa Toilet, undated.
- Courreges ad, undated.
- Ceramica ad for Dolomite Toilet, undated.

Primary Examiner—James R. Largen
Attorney, Agent, or Firm—Quarles & Brady

[57] CLAIM

The ornamental design for a toilet, as shown and described.

DESCRIPTION

FIG. 1 is a perspective view taken from the top, front and left side of a toilet showing our new design; FIG. 2 is a top plan view thereof; FIG. 3 is a left side elevational view thereof; FIG. 4 is a right side elevational view thereof; FIG. 5 is a front elevational view thereof; and FIG. 6 is a rear elevational view thereof. The broken line representation of an access panel in FIG. 4 is for the purpose of illustration only.

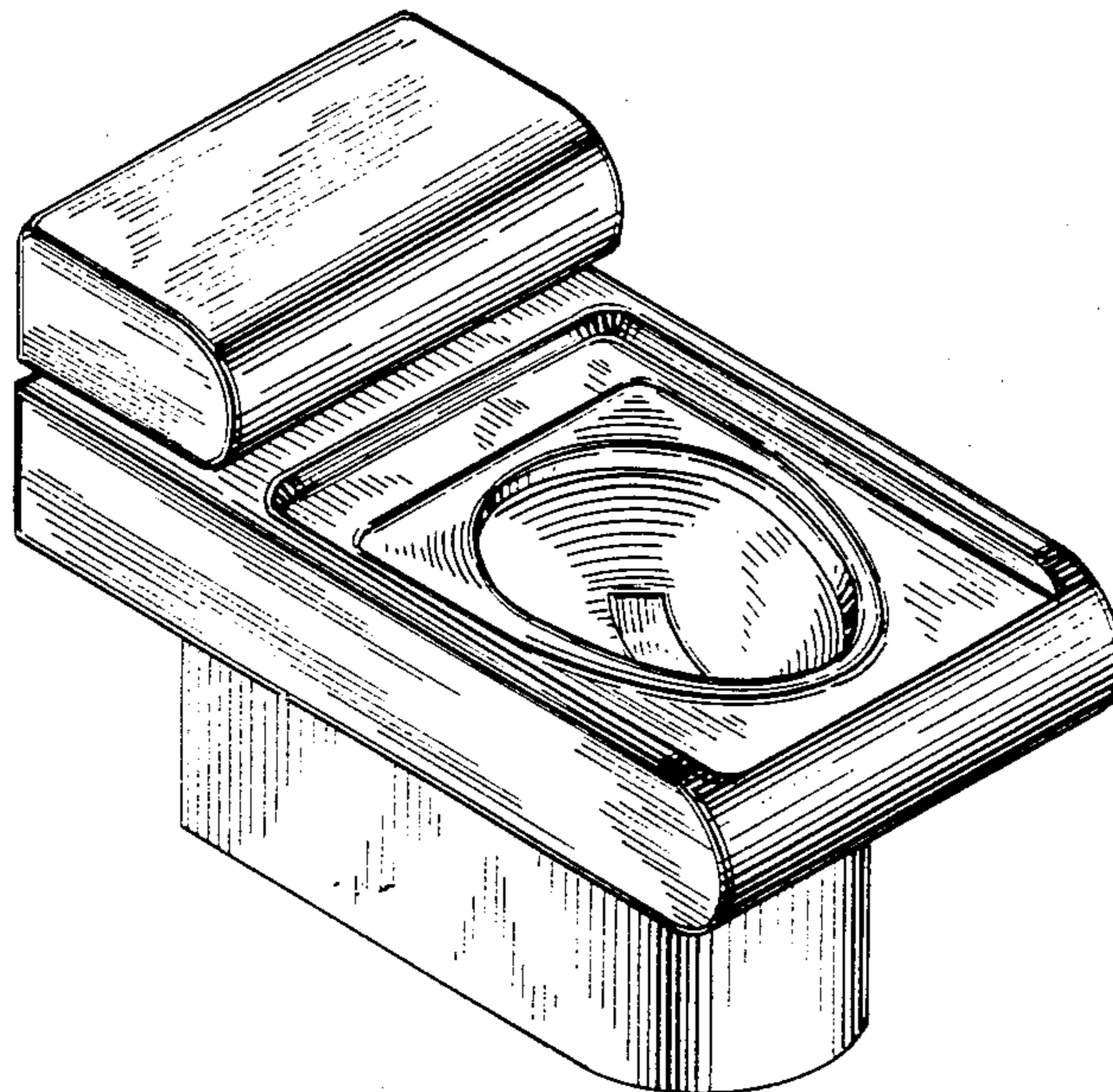

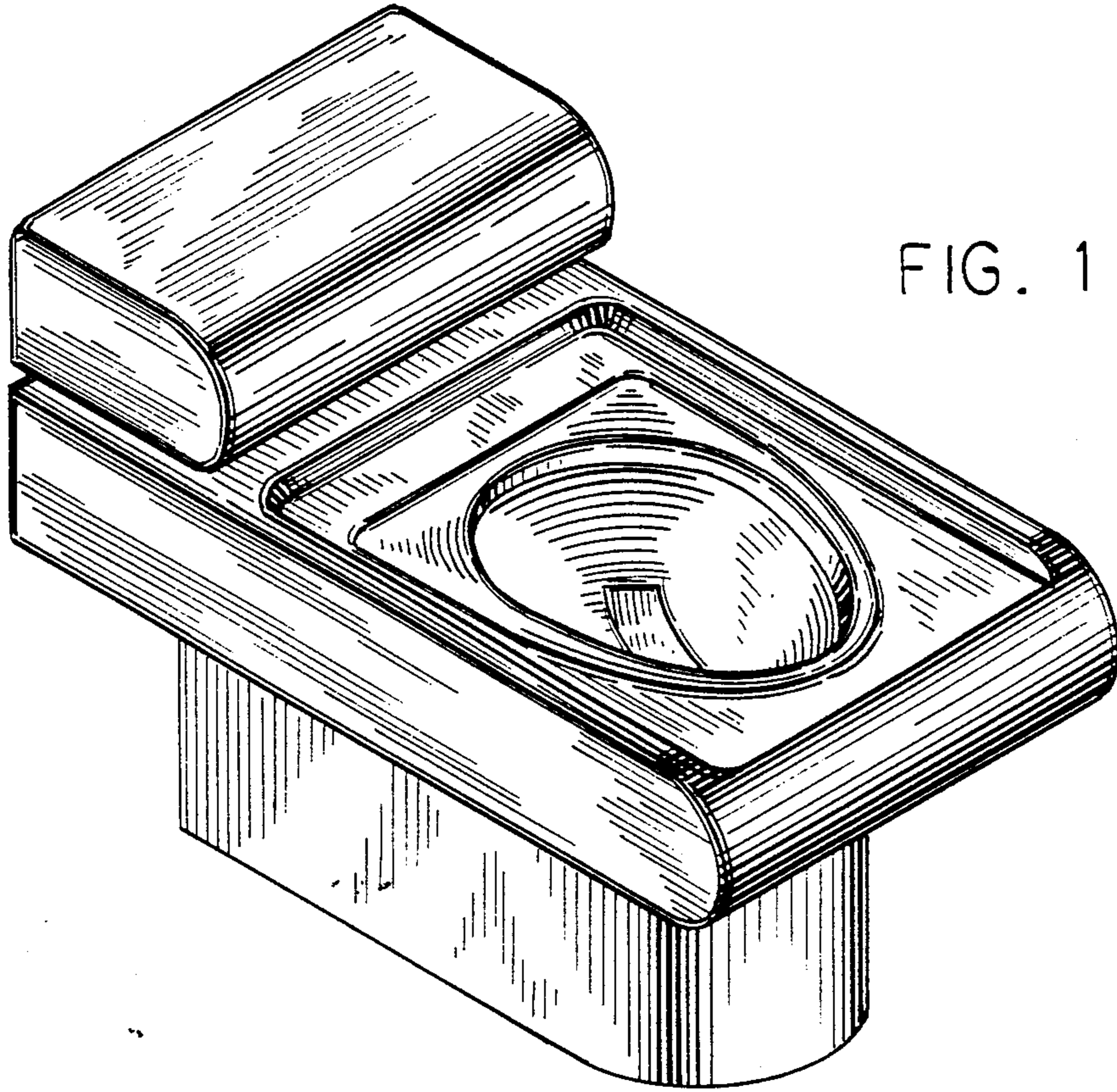

FIG. 1

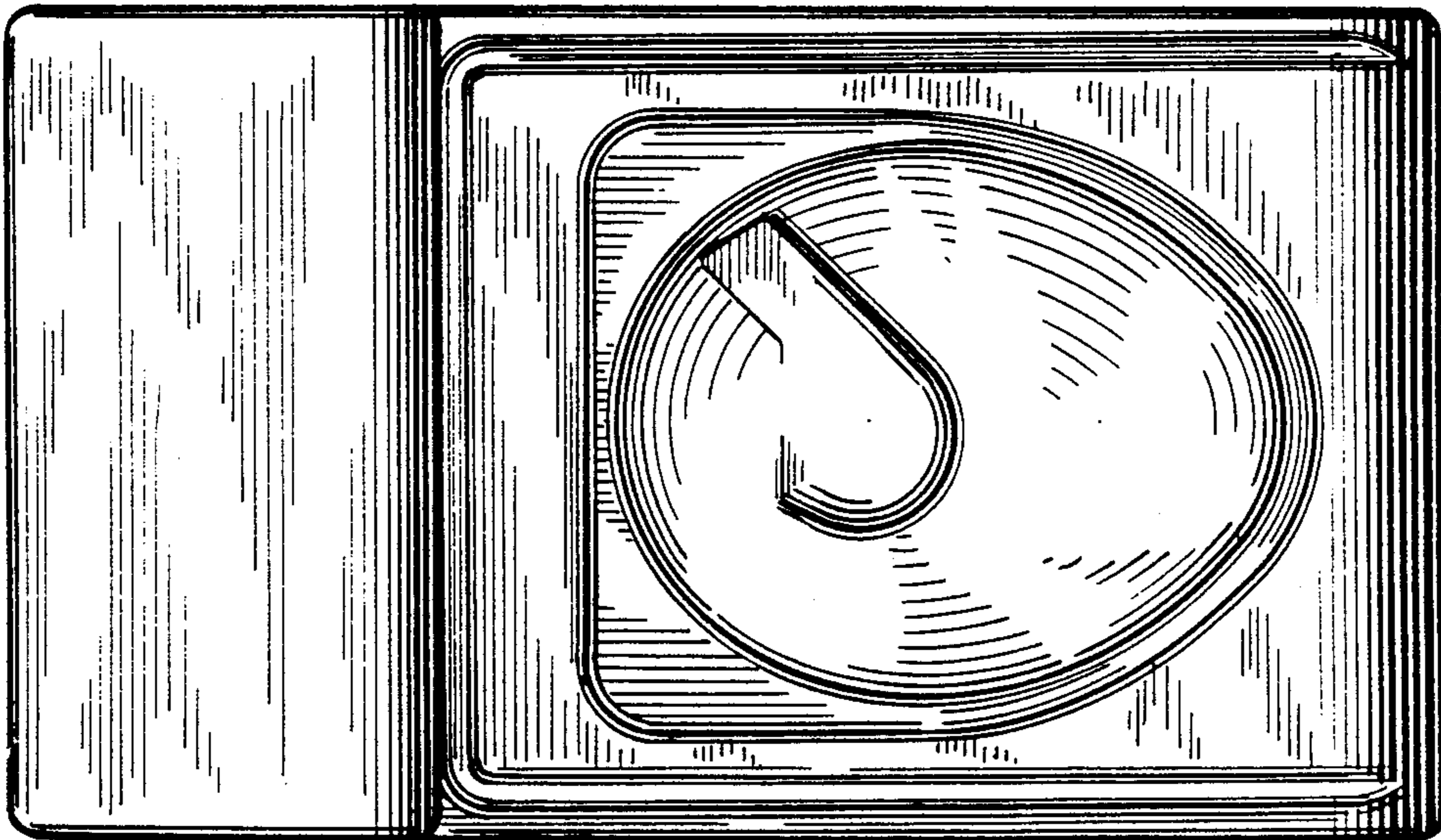

FIG. 2

FIG. 3

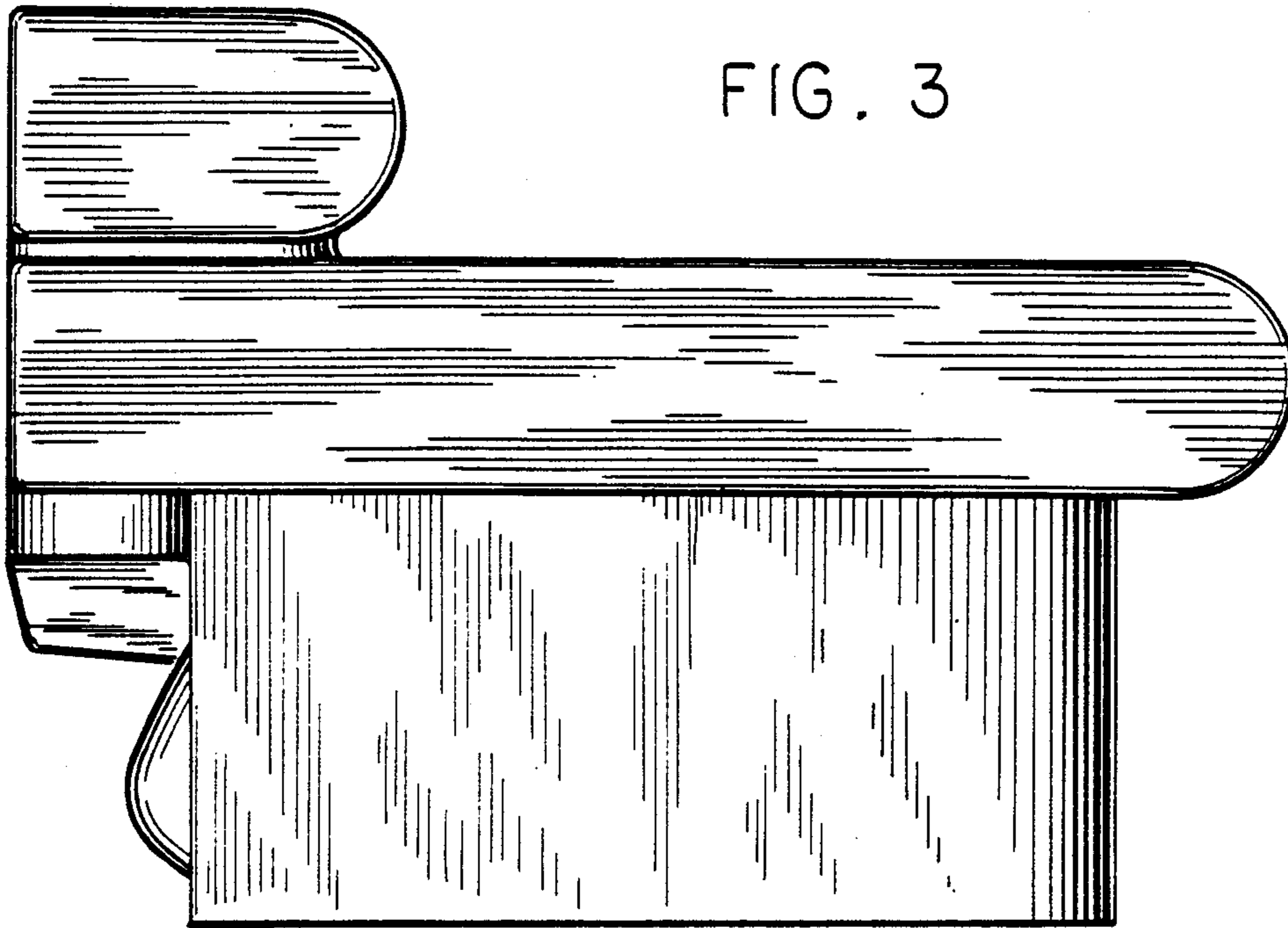
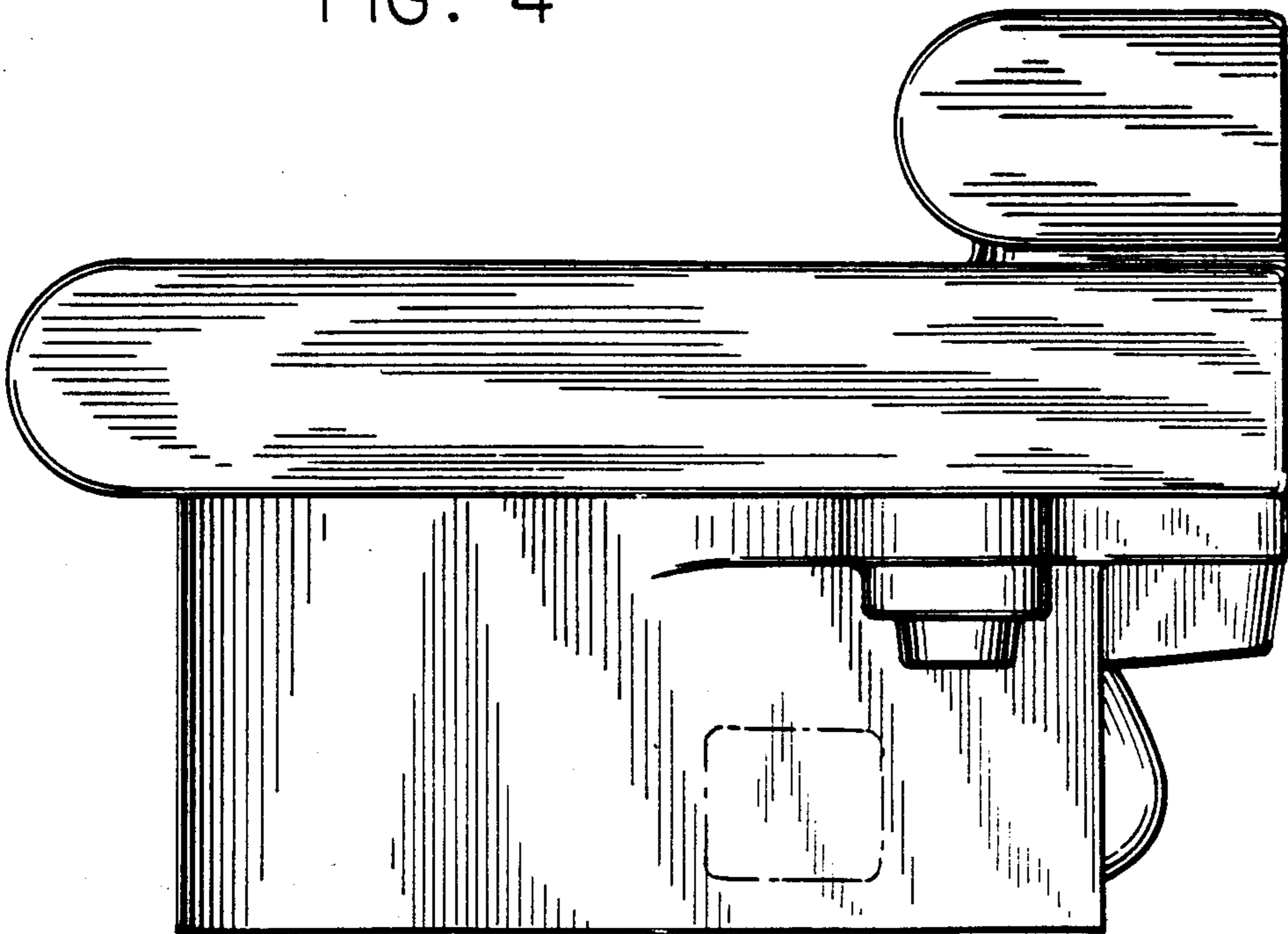

FIG. 4



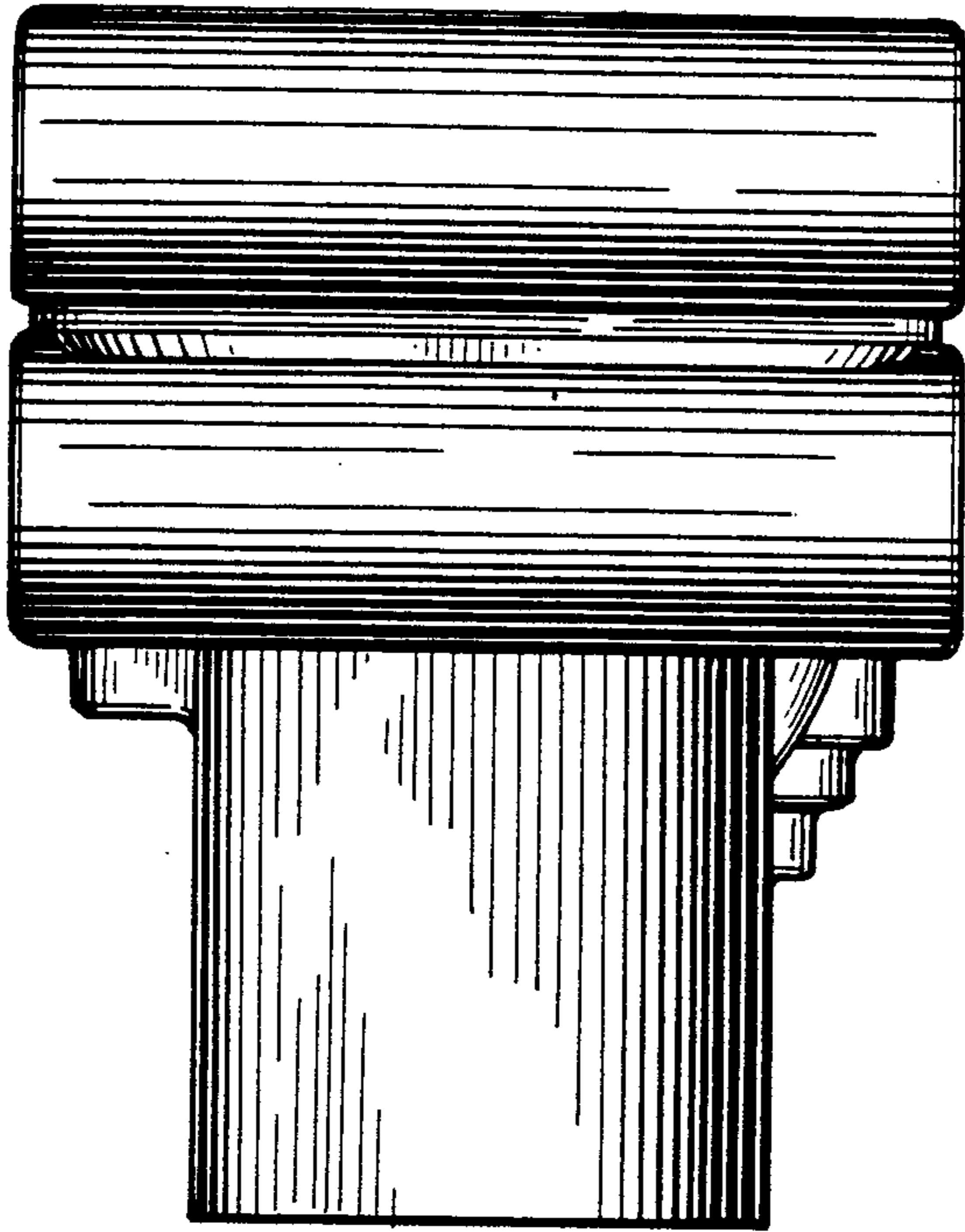

FIG. 5

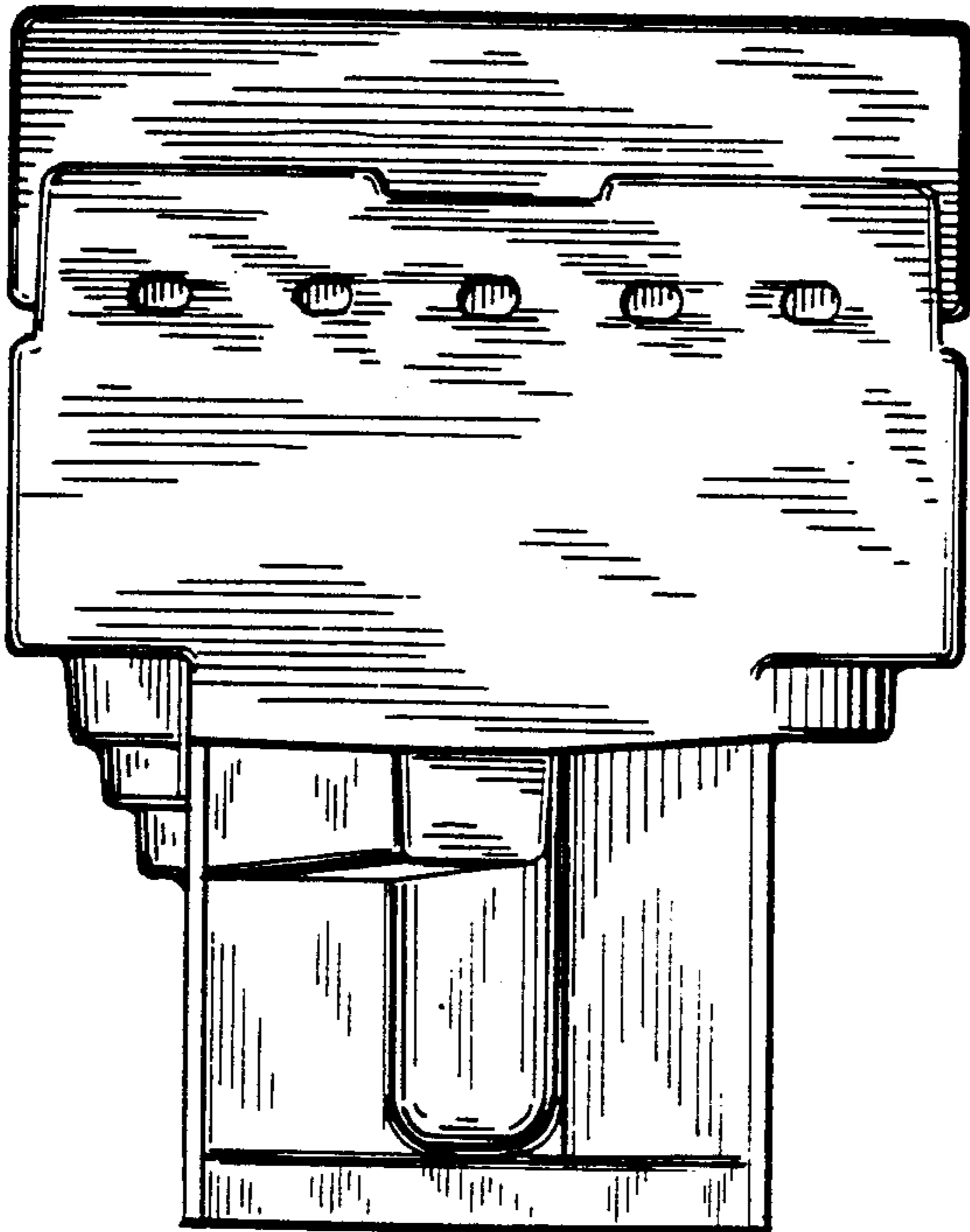

FIG. 6