

[54] **FILE BOX**

[75] **Inventors:** **Kent W. Murphy, Wooster; Charles W. Craft, Jr., Apple Creek, both of Ohio**

[73] **Assignee:** **Rubbermaid Incorporated, Wooster, Ohio**

[**] **Term:** **14 Years**

[21] **Appl. No.:** **117,648**

[22] **Filed:** **Nov. 5, 1987**

[52] **U.S. CL.** **D19/90; D19/75; D19/86**

[58] **Field of Search** **D19/65, 75, 86, 90, D19/92, 95, 99, 100; 206/214, 215, 425**

[56] **References Cited**

U.S. PATENT DOCUMENTS

D. 59,508	10/1921	Paulson	D19/90
D. 277,396	1/1985	Mahler	D19/90
D. 282,410	2/1986	Ekuan	D19/90
D. 285,098	8/1986	Ermanski et al.	D19/90
D. 299,037	12/1988	Klodt	D19/90

OTHER PUBLICATIONS

Office Appliances (Jan. 1955), p. 55, see File Box open, upper right.

Miles Kimball Co. (Jan. 1953), p. 22, see File Box #GM2864, lower left center.

Catalog page, Essette Pendeflex Corp., Clinton Rd., Garden City, NJ 11530. Publication date unknown.

Catalog page, Staco Products Co., 2442 Estand Way, Pleasant Hill, CA 94523. Publication date unknown.

Catalog page, W. T. Rogers Co., 1401 Badger Rd., P.O. Box 4327, Madison, WI 53711. Publication date unknown.

P. 3, Filer Incorporated, P.O. Box 6696, 800 S. Palm, Alhambra, CA 91803. Publication date unknown.

Primary Examiner—Bruce W. Dunkins

Assistant Examiner—Martha Thompson

Attorney, Agent, or Firm—Richard B. O'Planick

[57] **CLAIM**

The ornamental design for a file box, as shown and described.

DESCRIPTION

FIG. 1 is a front perspective view of a file box showing our new design;

FIG. 2 is a side elevational view, the opposite side being a mirror image thereof;

FIG. 3 is a top plan view;

FIG. 4 is a bottom plan view;

FIG. 5 is a front elevational view; and

FIG. 6 is a rear elevational view thereof.

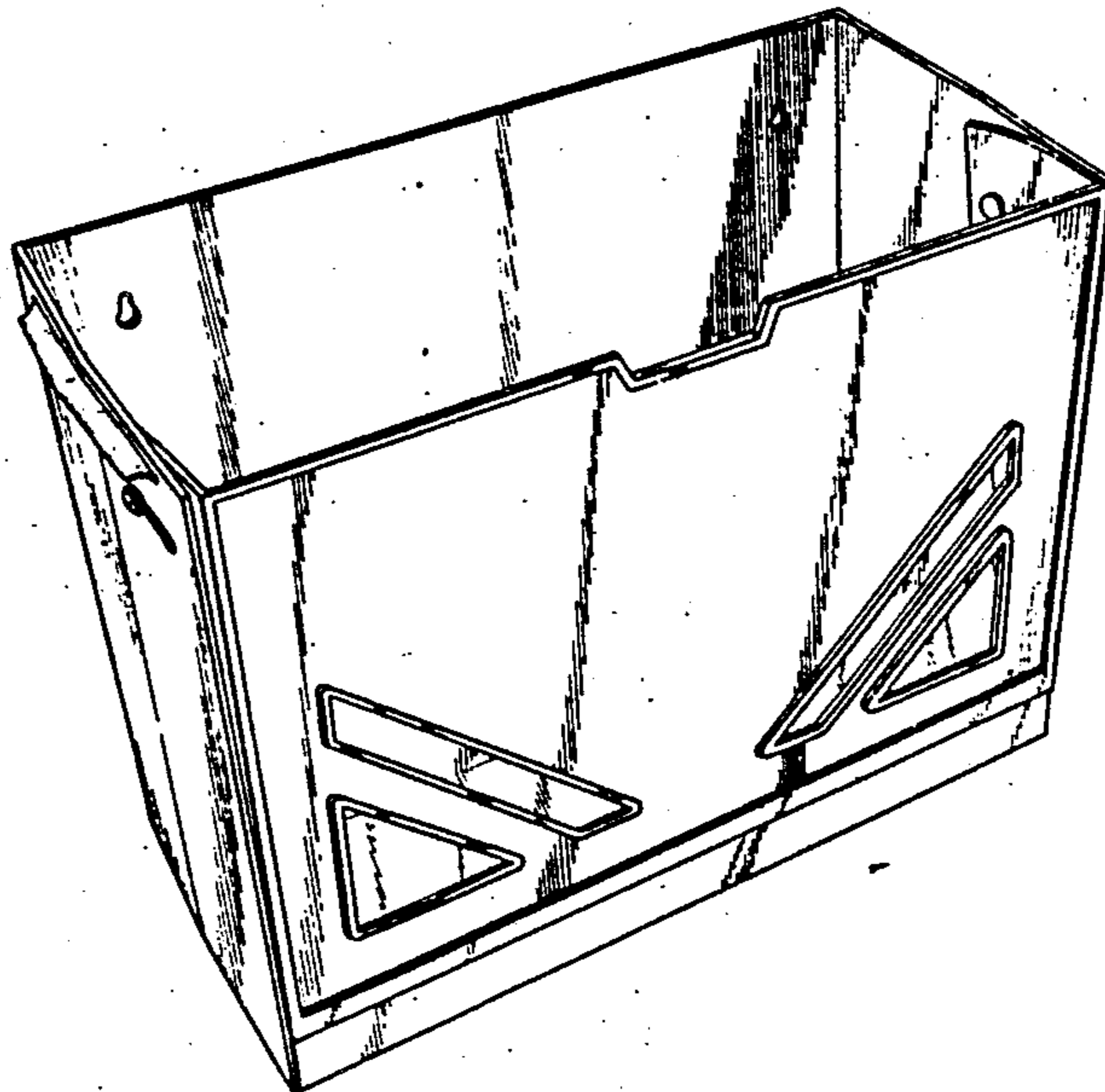

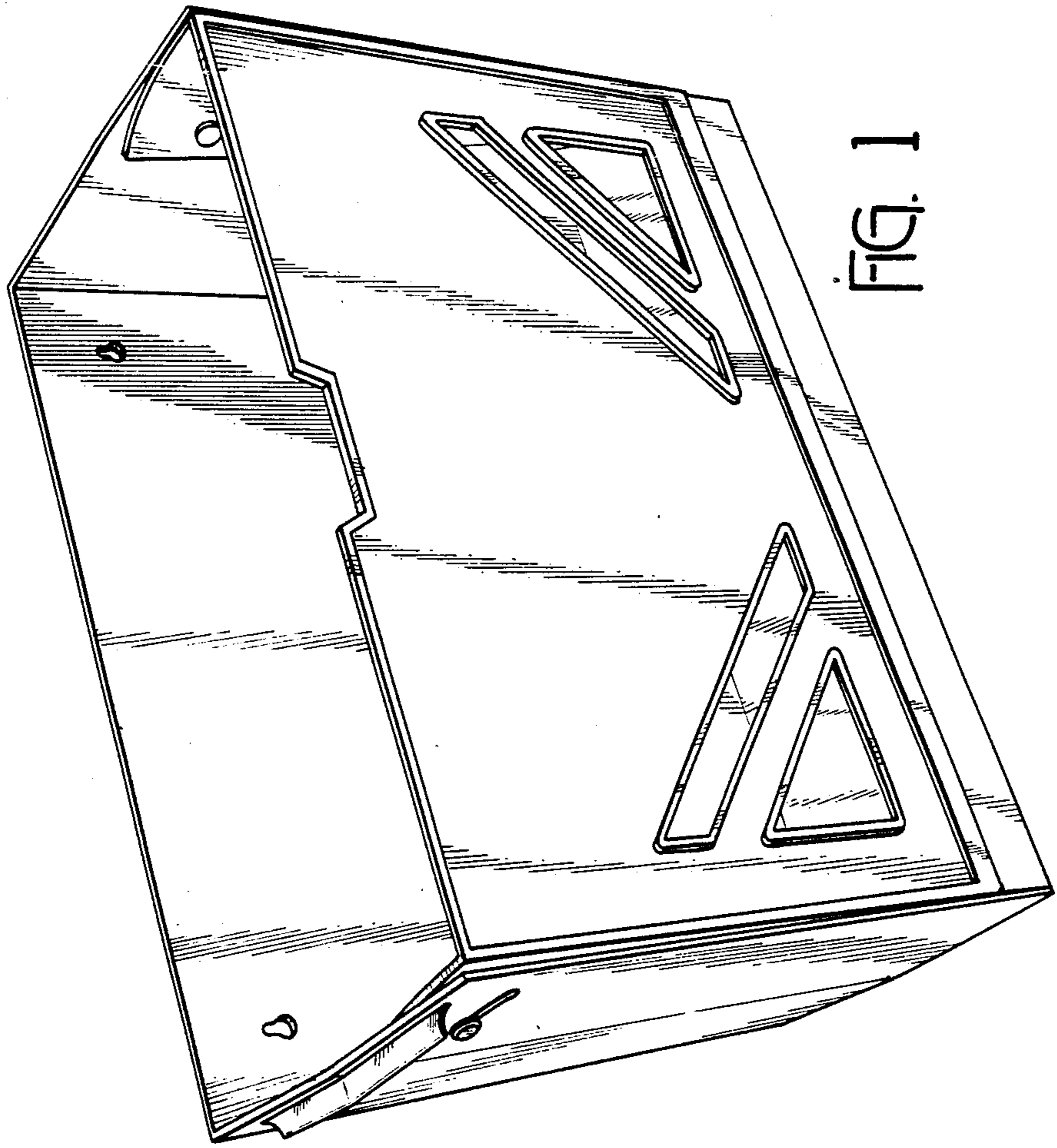

FIG. 1

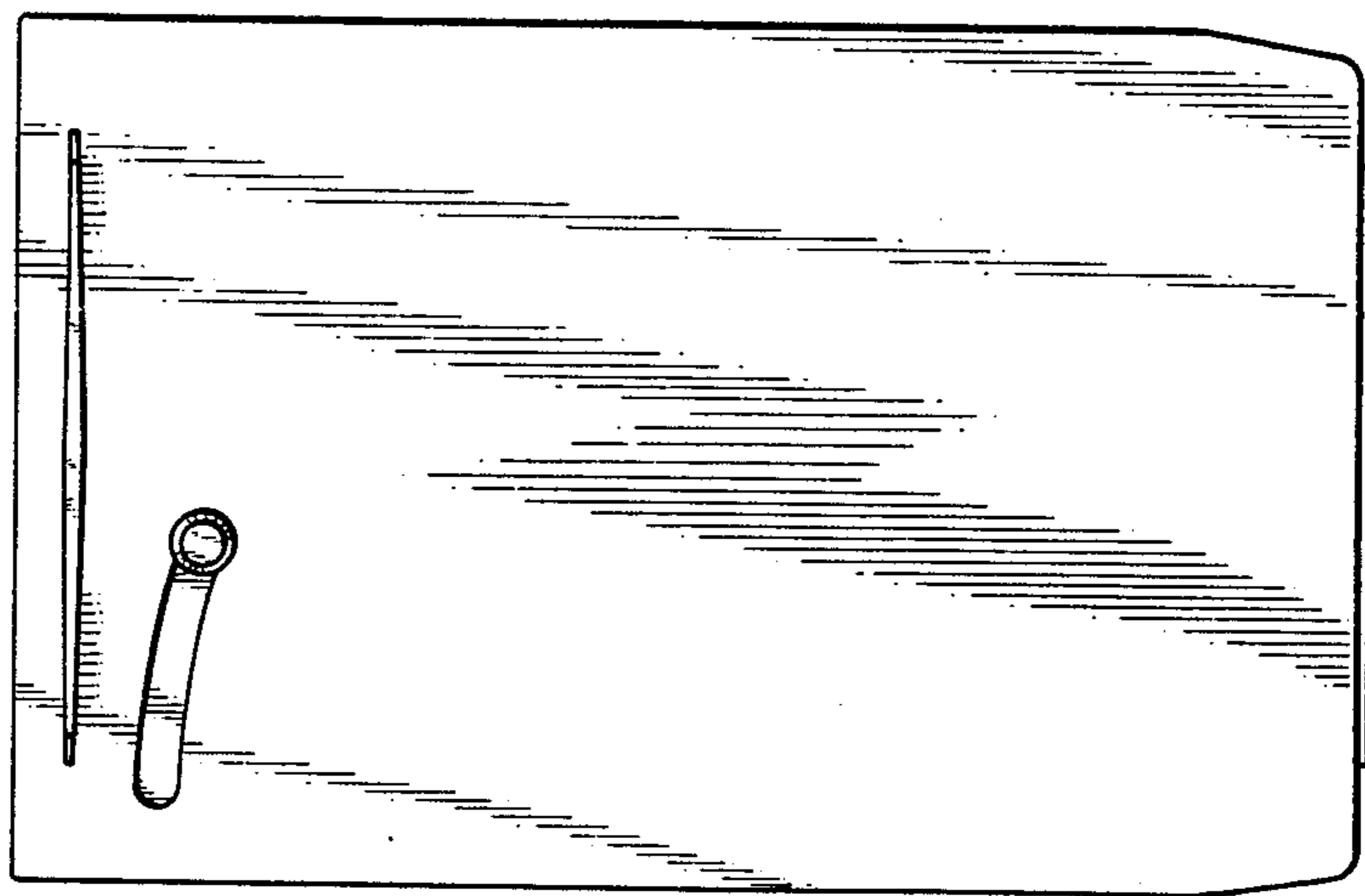

FIG. 2

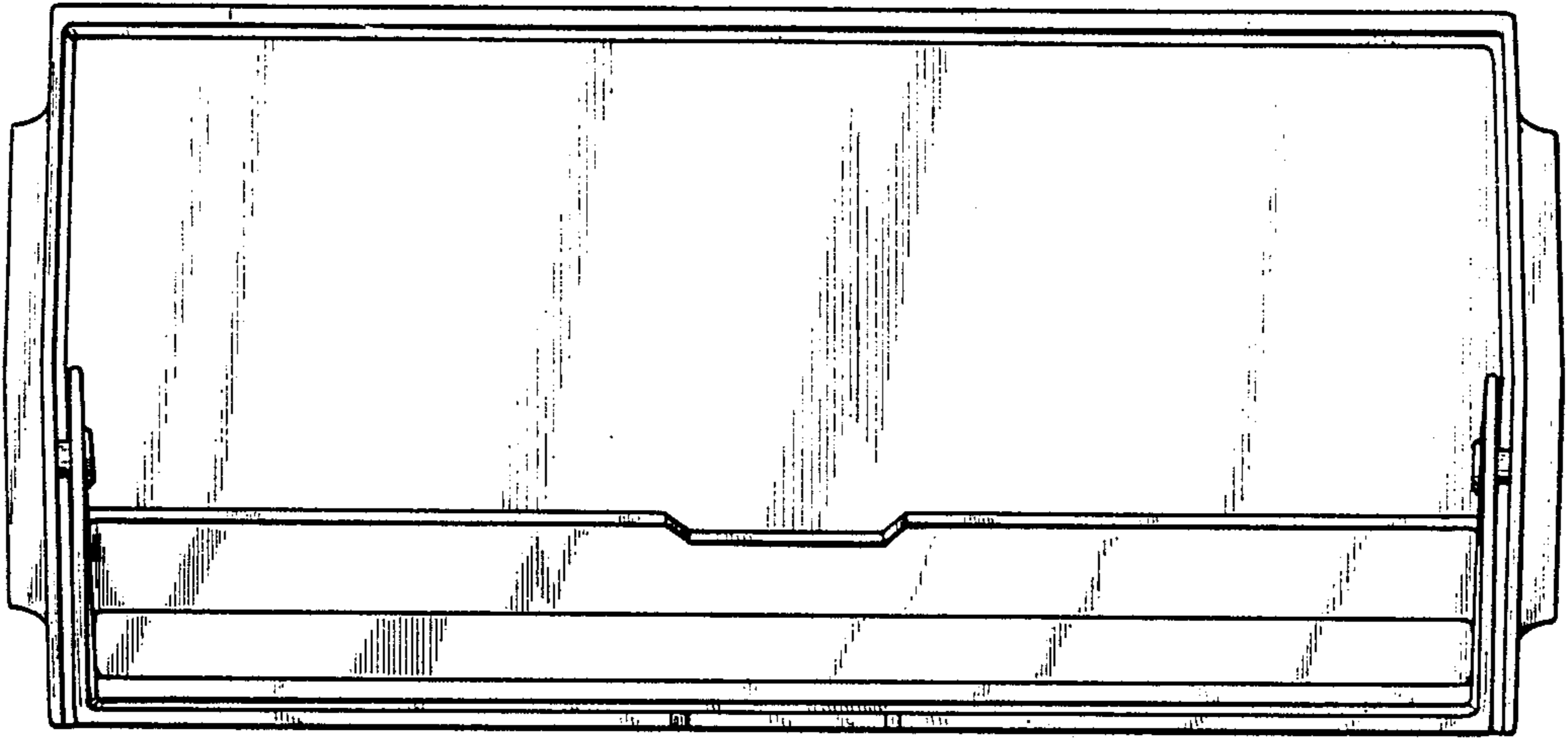

FIG. 3

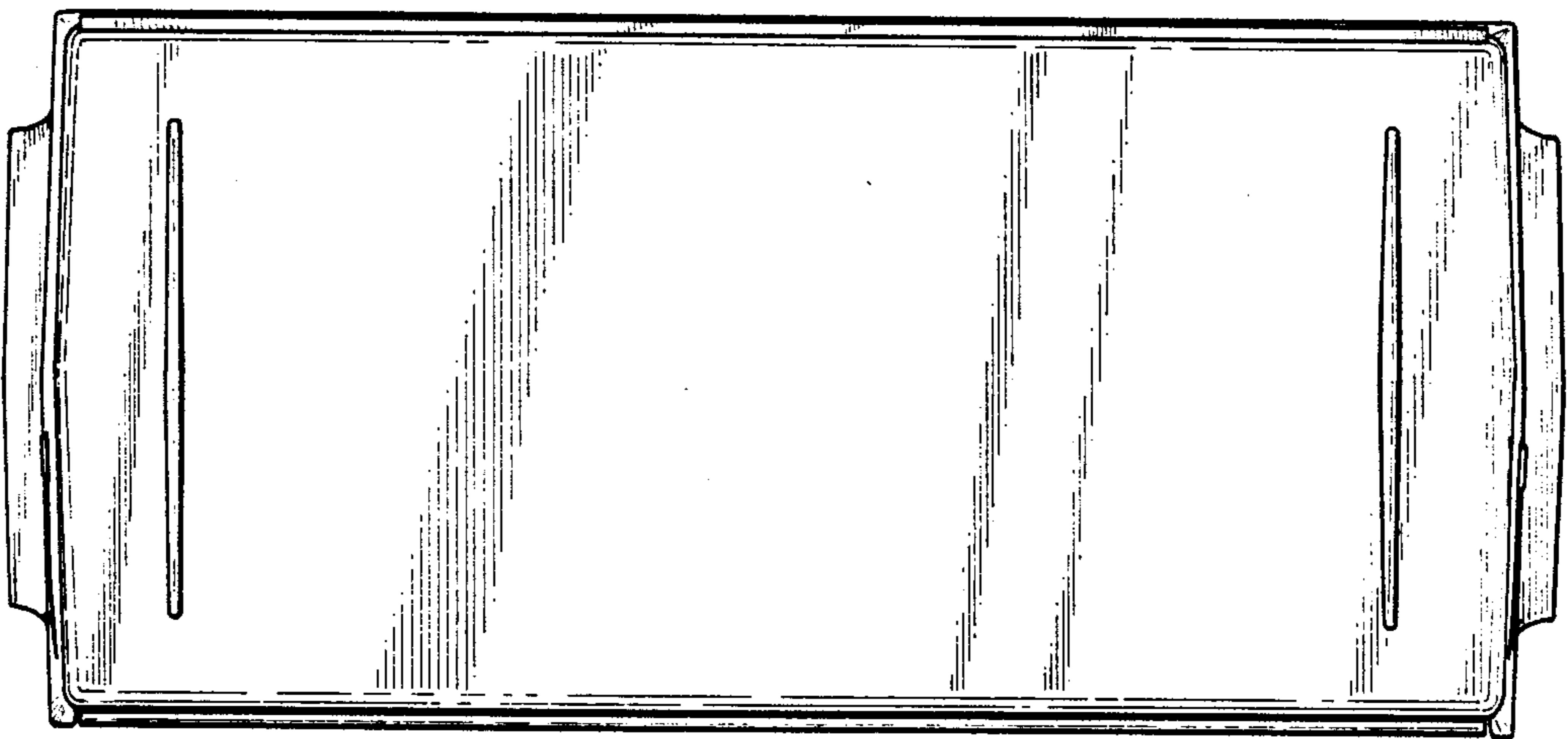

FIG. 4

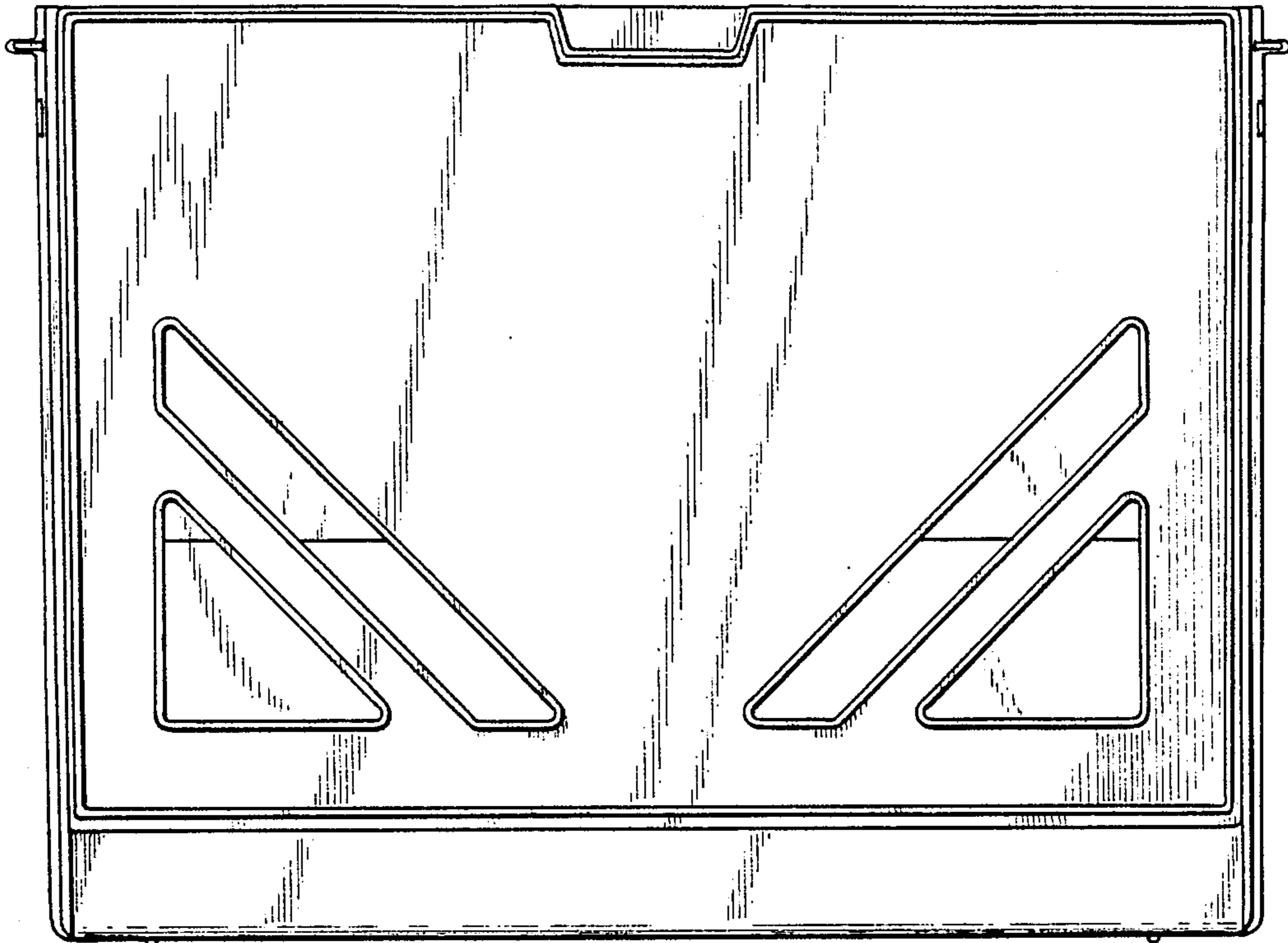

FIG. 5

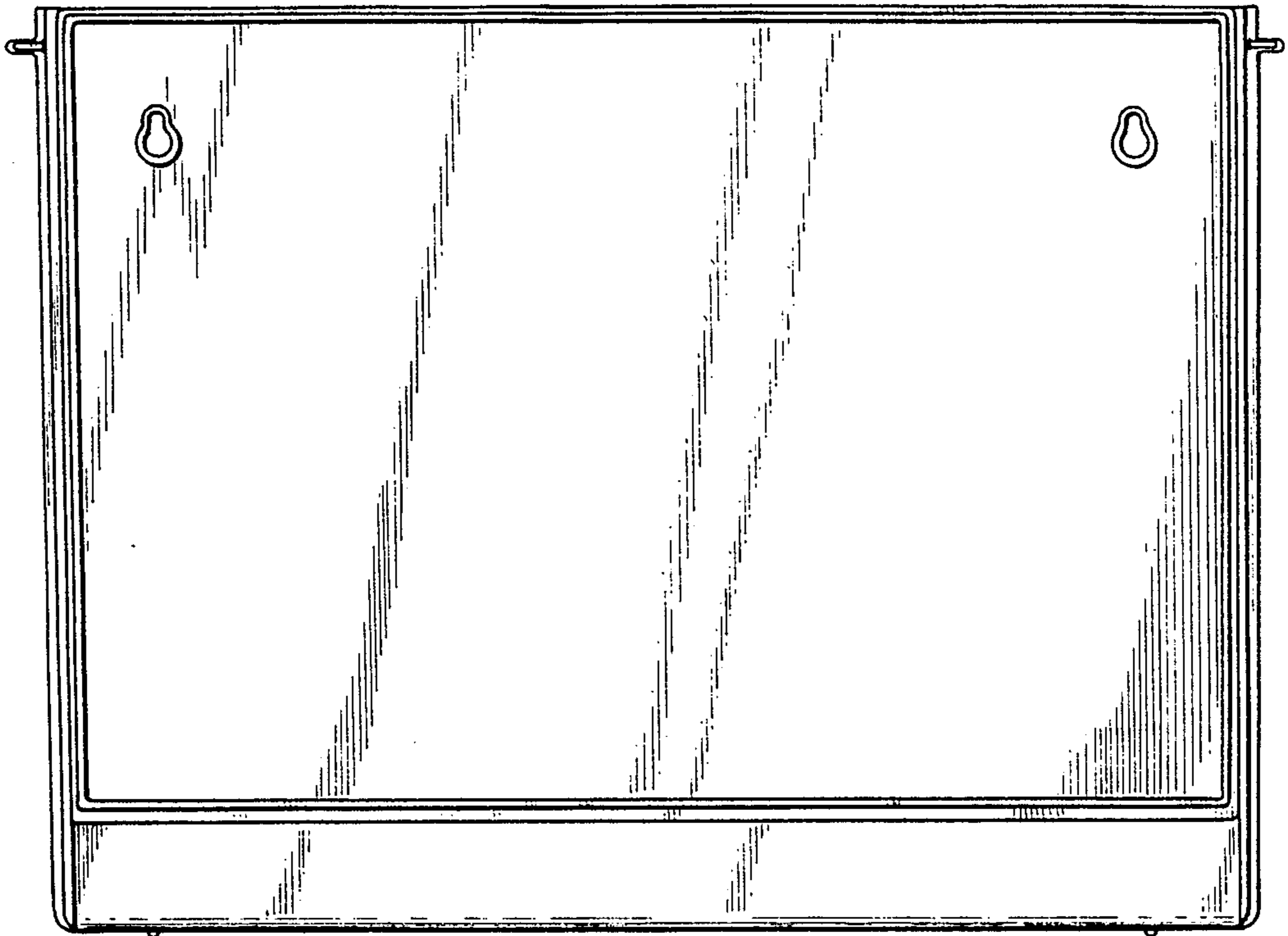

FIG. 6