

[54] DIGITAL AUDIO TAPE RECORDER

[75] Inventor: Yoshitaka Naito, Tachikawa, Japan

[73] Assignee: Casio Computer Co., Ltd., Tokyo, Japan

[**] Term: 14 Years

[21] Appl. No.: 58,024

[22] Filed: Jun. 4, 1987

[30] Foreign Application Priority Data

Dec. 22, 1986 [JP] Japan 61-50693
[52] U.S. Cl. D14/164; D14/161
[58] Field of Search D14/141, 160-168, D14/188-189, 191-192, 196, 199, 202, 299; 455/344, 350-351

[56] References Cited

U.S. PATENT DOCUMENTS

D. 217,677 5/1970 Larson D14/164
D. 237,389 10/1975 Schmitz D14/164
D. 257,975 1/1981 Miki D14/165

OTHER PUBLICATIONS

Stereo Discounters Electric World catalog; p. 64; top left—Technics Digital Audio Player.

Primary Examiner—Theodore M. Shooman
Attorney, Agent, or Firm—Frishauf, Holtz, Goodman & Woodward

[57] CLAIM

The ornamental design for a digital audio tape recorder, as shown and described.

DESCRIPTION

FIG. 1 is a top plan view of a digital audio tape recorder showing my new design;
FIG. 2 is a rear elevational view thereof, rotated 180 degrees from FIG. 1.
FIG. 3 is a right side elevational view thereof, rotated 90 degrees from FIG. 1;
FIG. 4 is a left side elevational view thereof, rotated 90 degrees from FIG. 1;
FIG. 5 is a front elevational view thereof;
FIG. 6 is a bottom plan view thereof; and
FIG. 7 is a top, front and left side perspective view thereof.

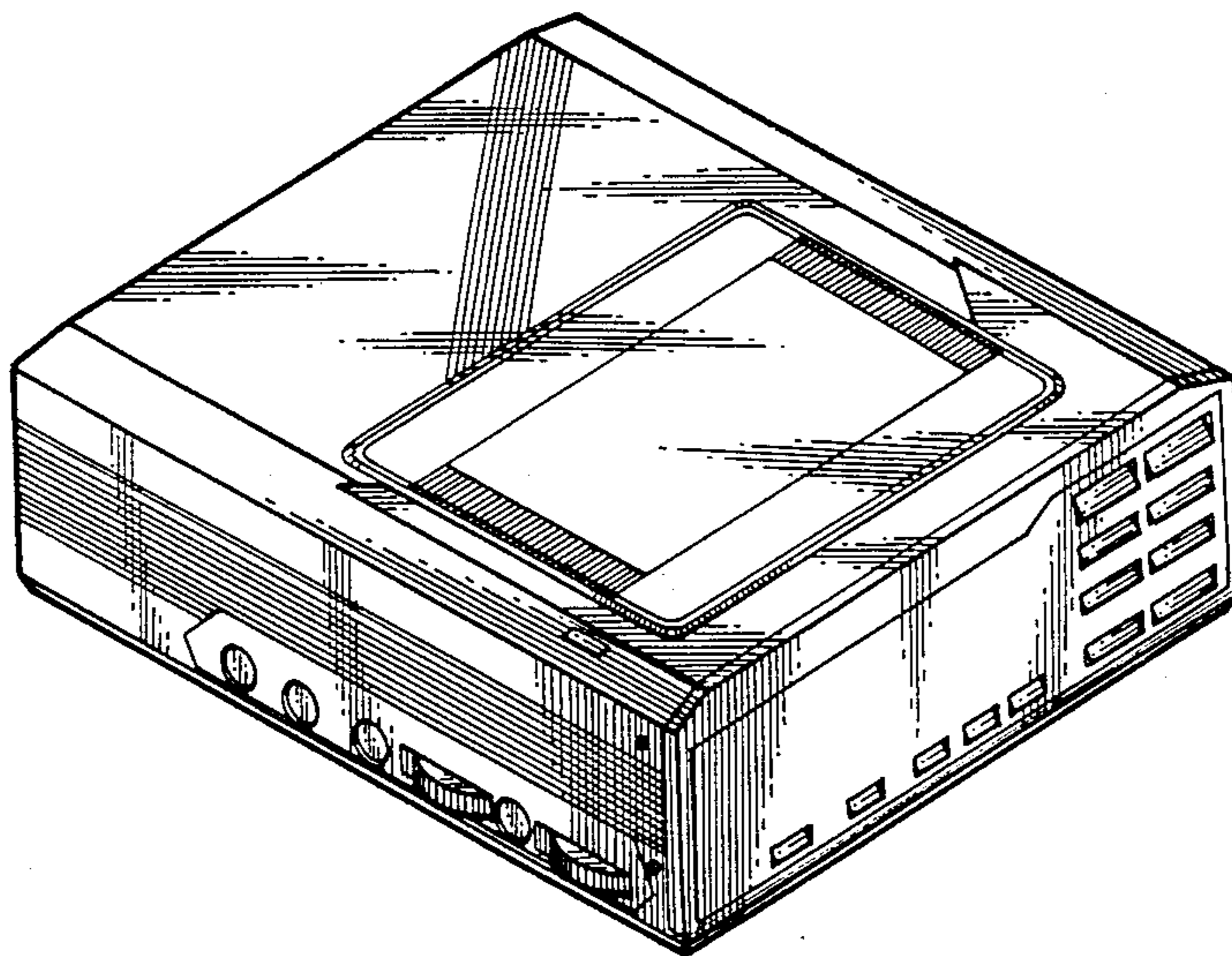

FIG. 2

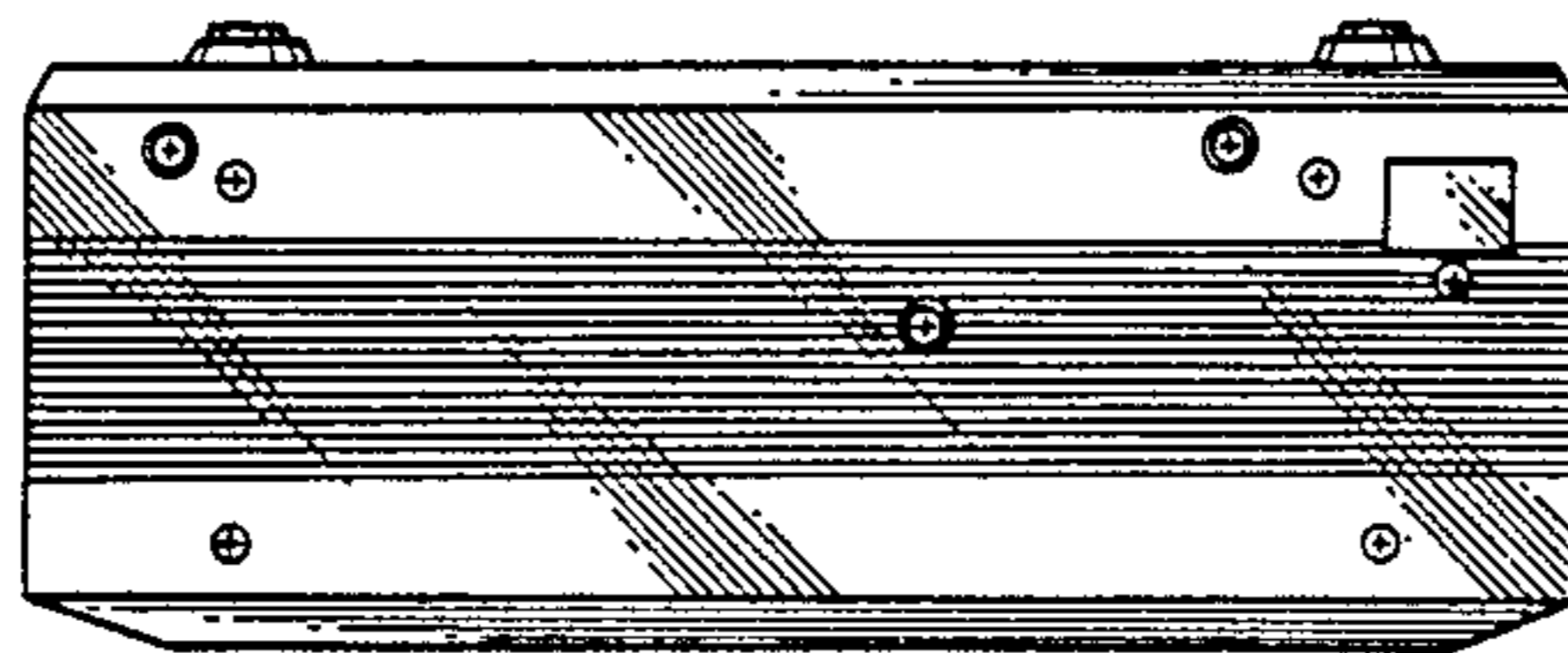

FIG. 4

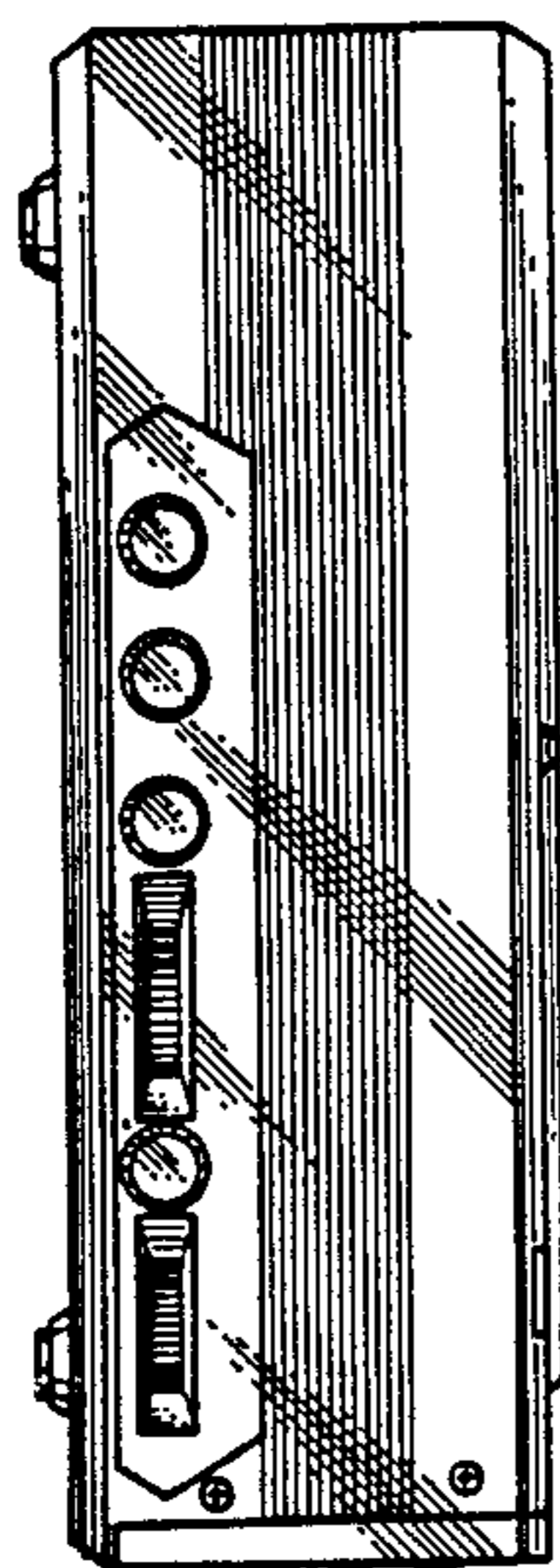

FIG. 1

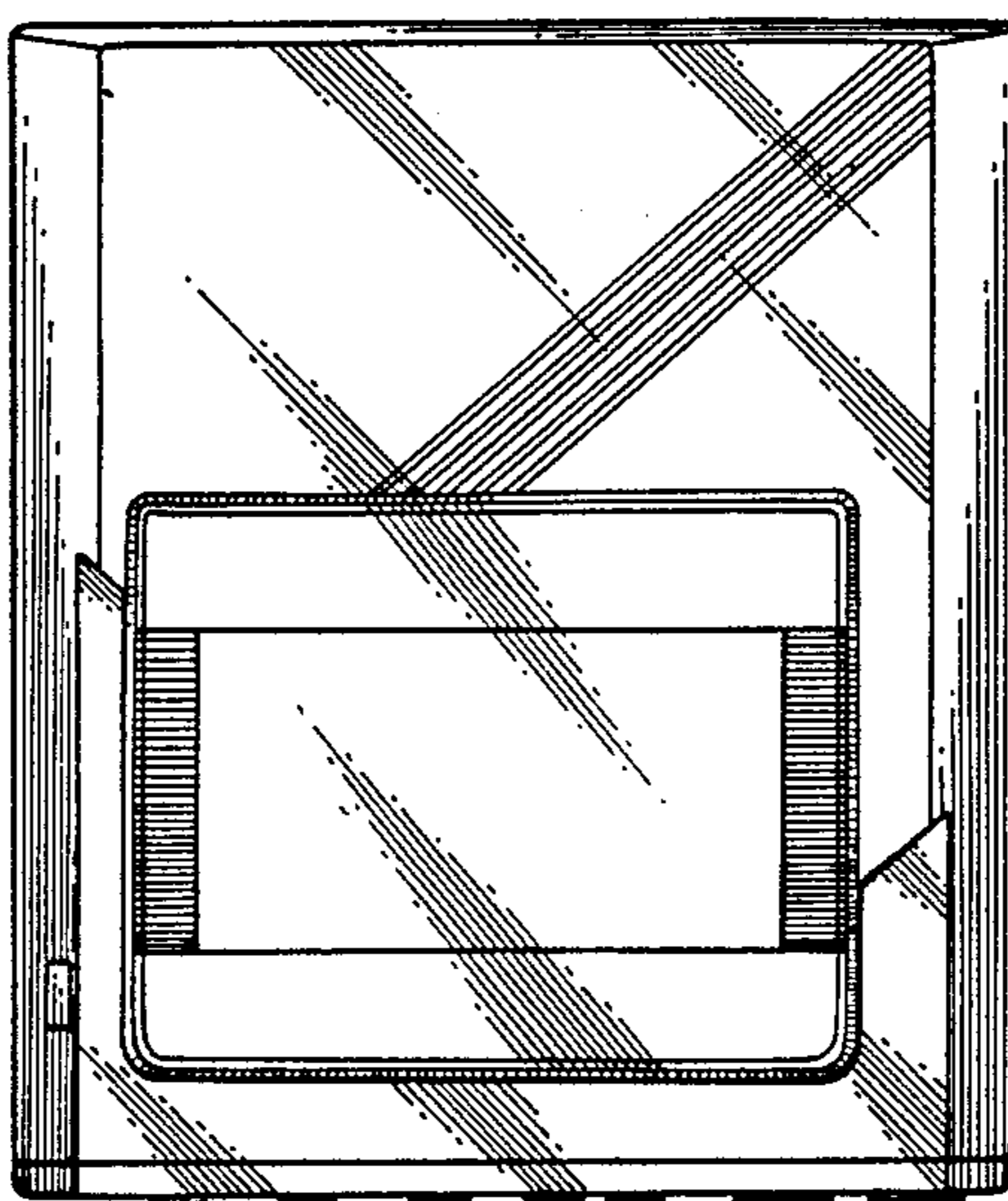

FIG. 3

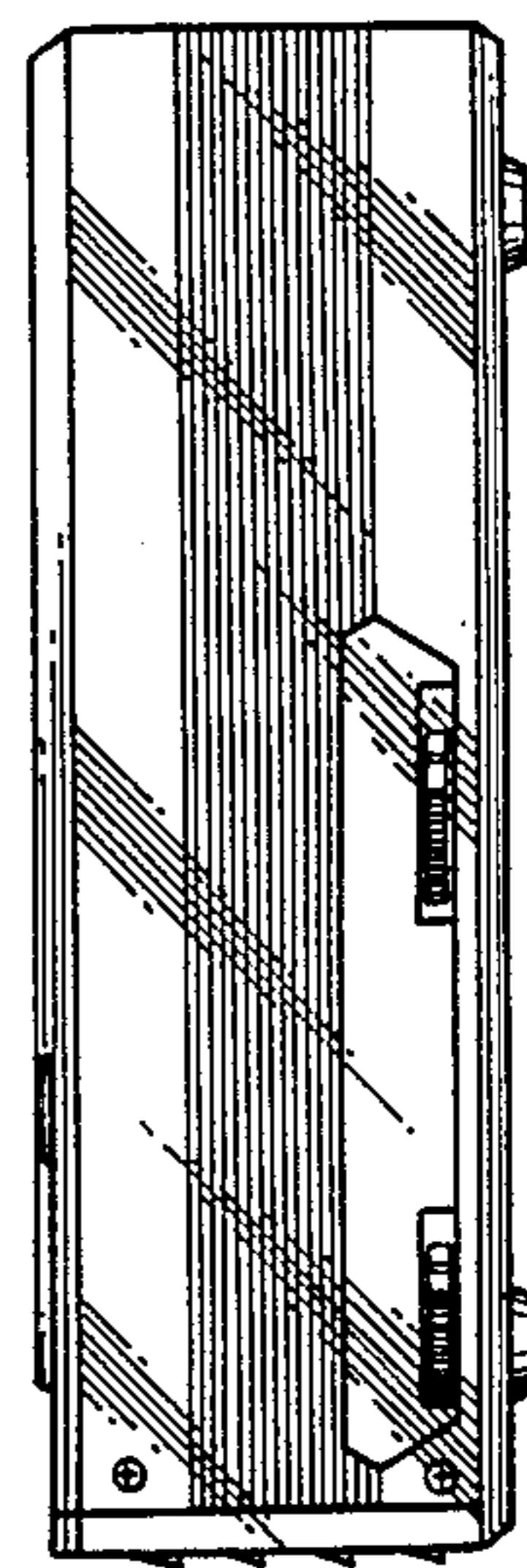

FIG. 5

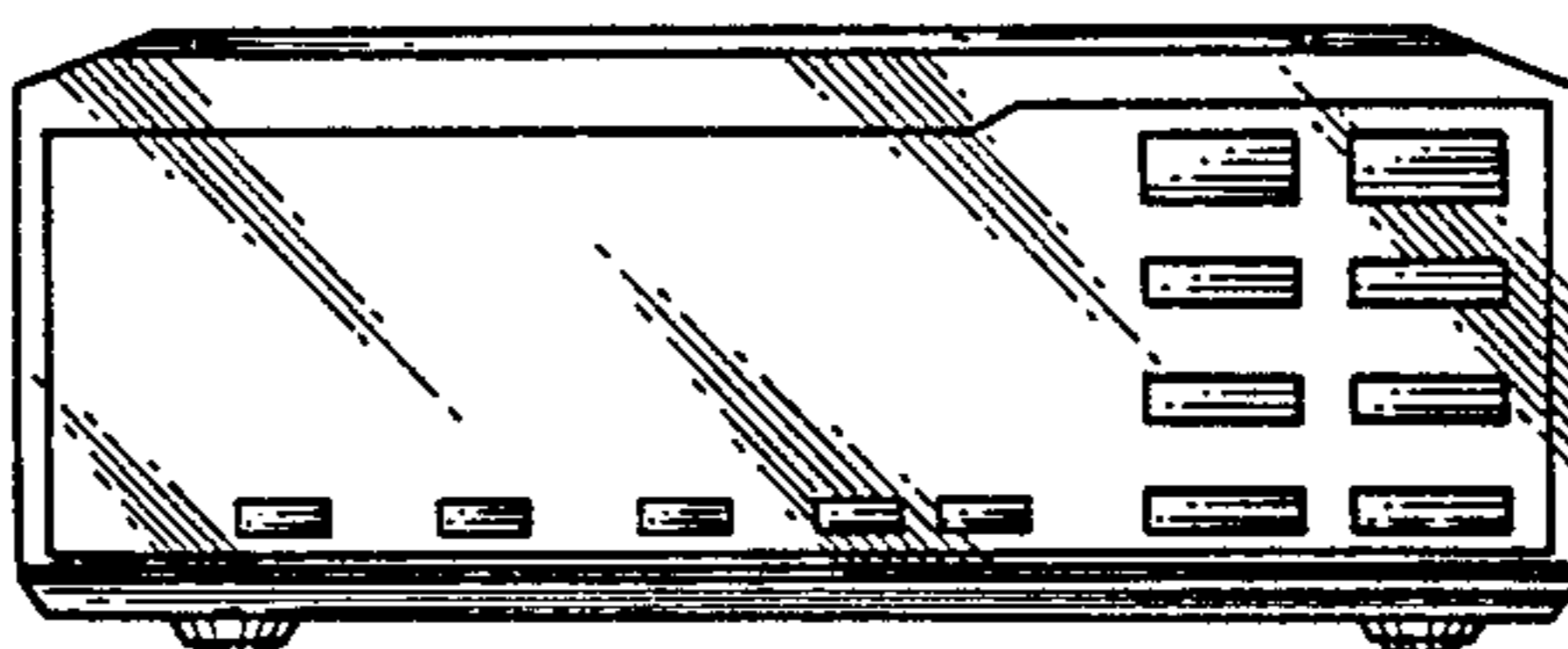

FIG. 6

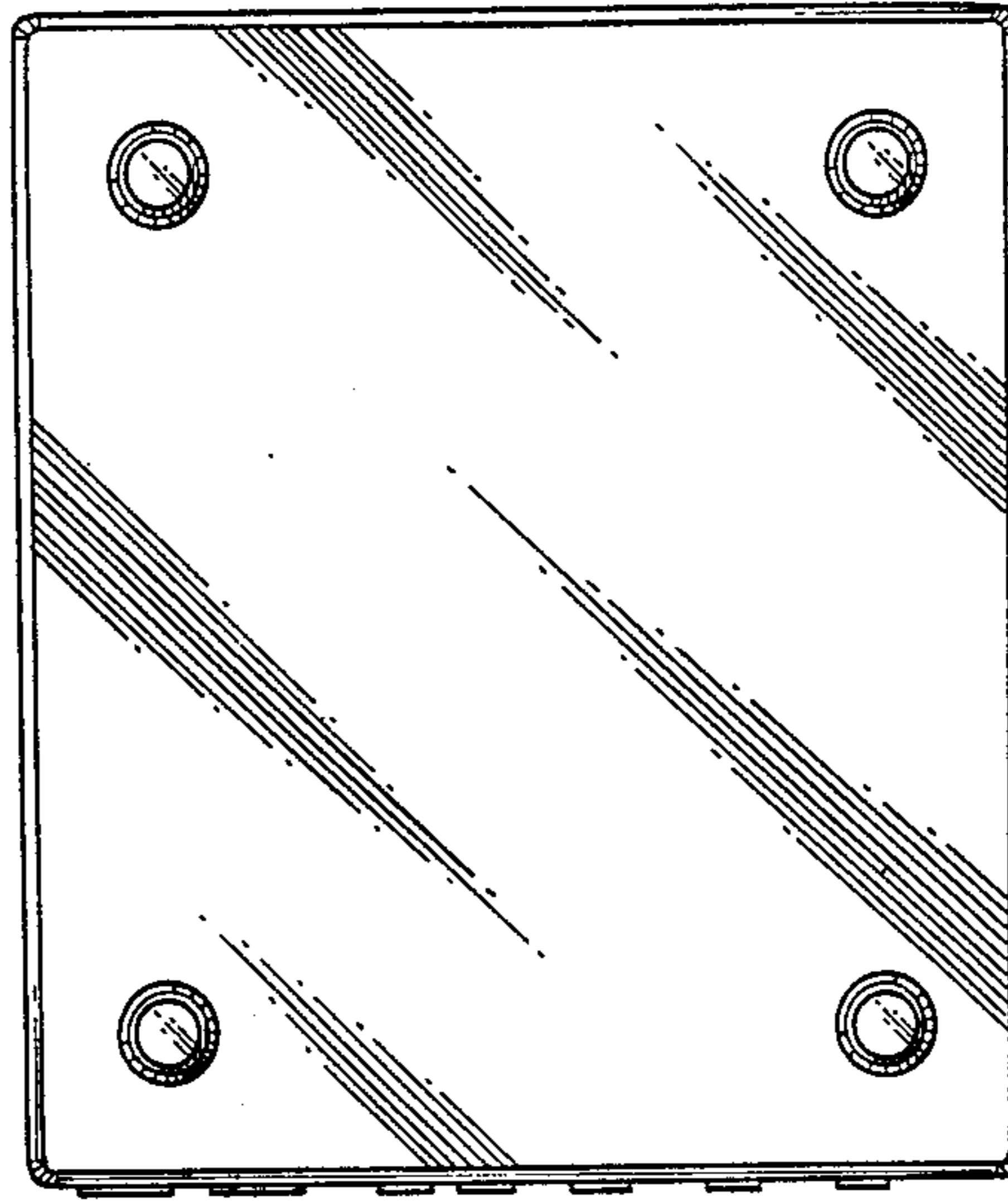

FIG. 7

