

[54] WRIST WATCH CASE HAVING PROTECTOR

[75] Inventor: Makoto Ito, Fussa, Japan

[73] Assignee: Casio Computer Co., Ltd., Tokyo, Japan

[**] Term: 14 Years

[21] Appl. No.: 62,192

[22] Filed: Jun. 11, 1987

[52] U.S. Cl. D10/30; D10/38; D10/132

[58] Field of Search D10/1-39, D10/122-132; 368/276, 277, 280-282, 285-286

[56] References Cited

U.S. PATENT DOCUMENTS

D. 165,599 1/1952 Newhouse D10/38

D. 292,678 11/1987 Takeichi D10/39

Primary Examiner—Nelson C. Holtje
Attorney, Agent, or Firm—Frishauf, Holtz, Goodman & Woodward

[57] CLAIM

The ornamental design for a wrist watch case having protector, as shown and described.

DESCRIPTION

FIG. 1 is a front elevational view of a wrist watch case having protector showing my new design;
FIG. 2 is a top plan view thereof;
FIG. 3 is a right side elevational view thereof;
FIG. 4 is a left side elevational view thereof;
FIG. 5 is a bottom plan view thereof;
FIG. 6 is a rear elevational view thereof with portions of the protector bars omitted for ease of illustration;
FIG. 7 is a perspective view thereof.

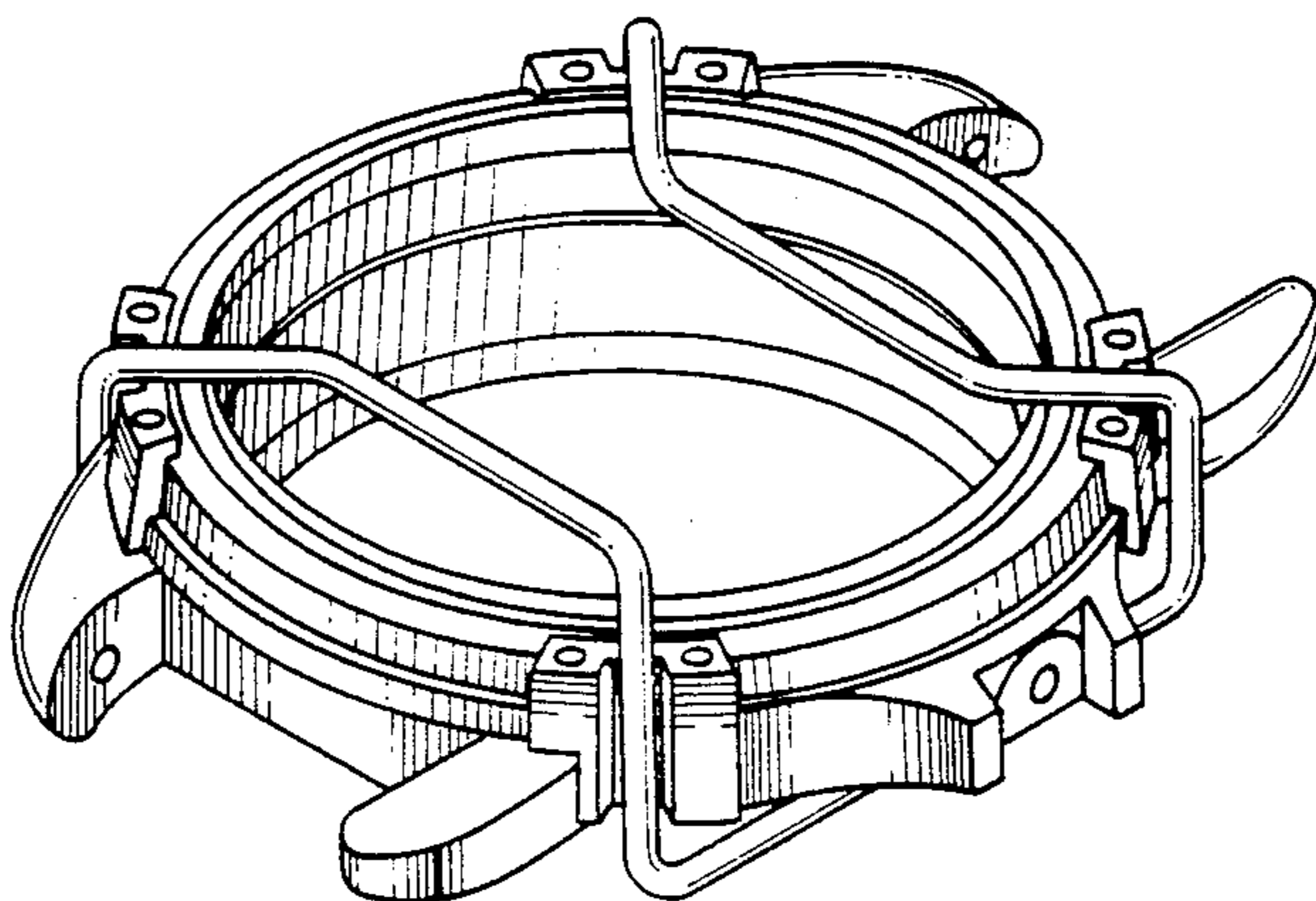

FIG. 2

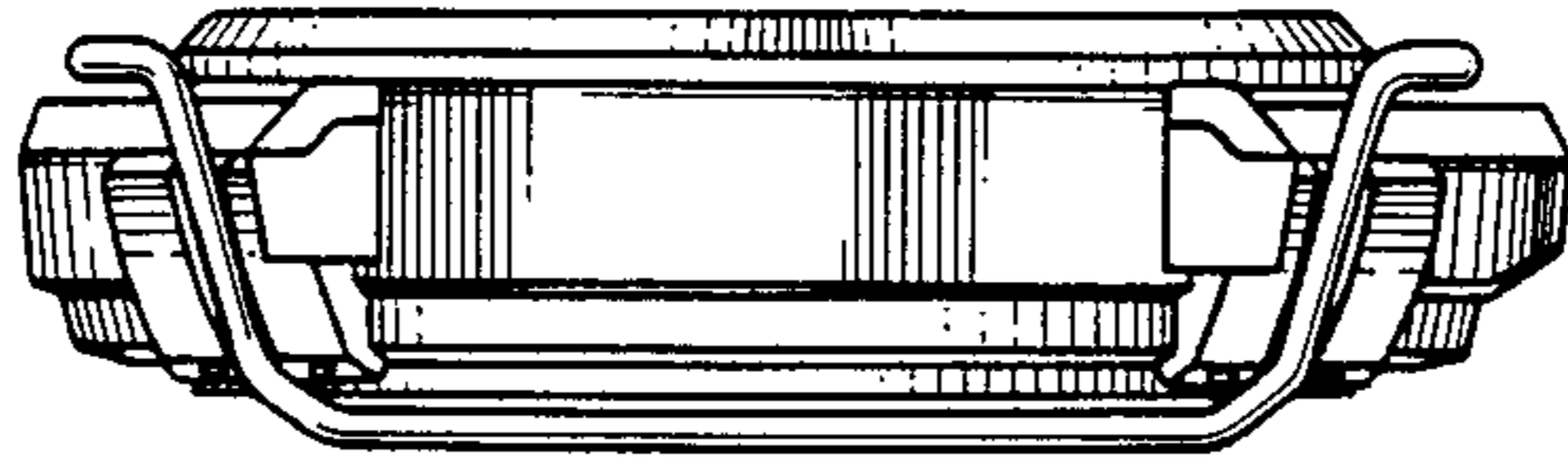

FIG. 4

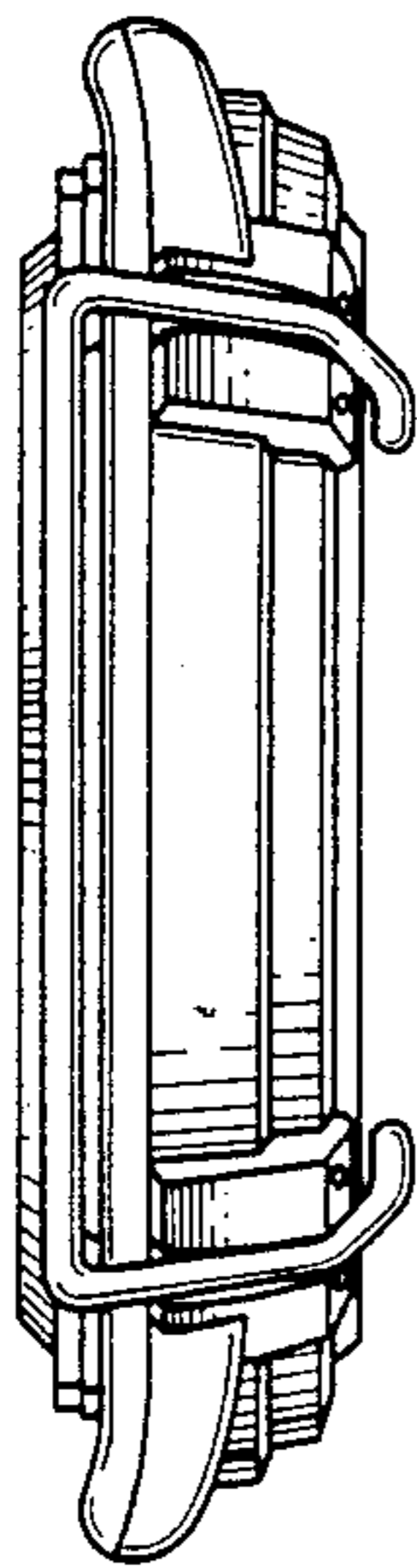

FIG. 1

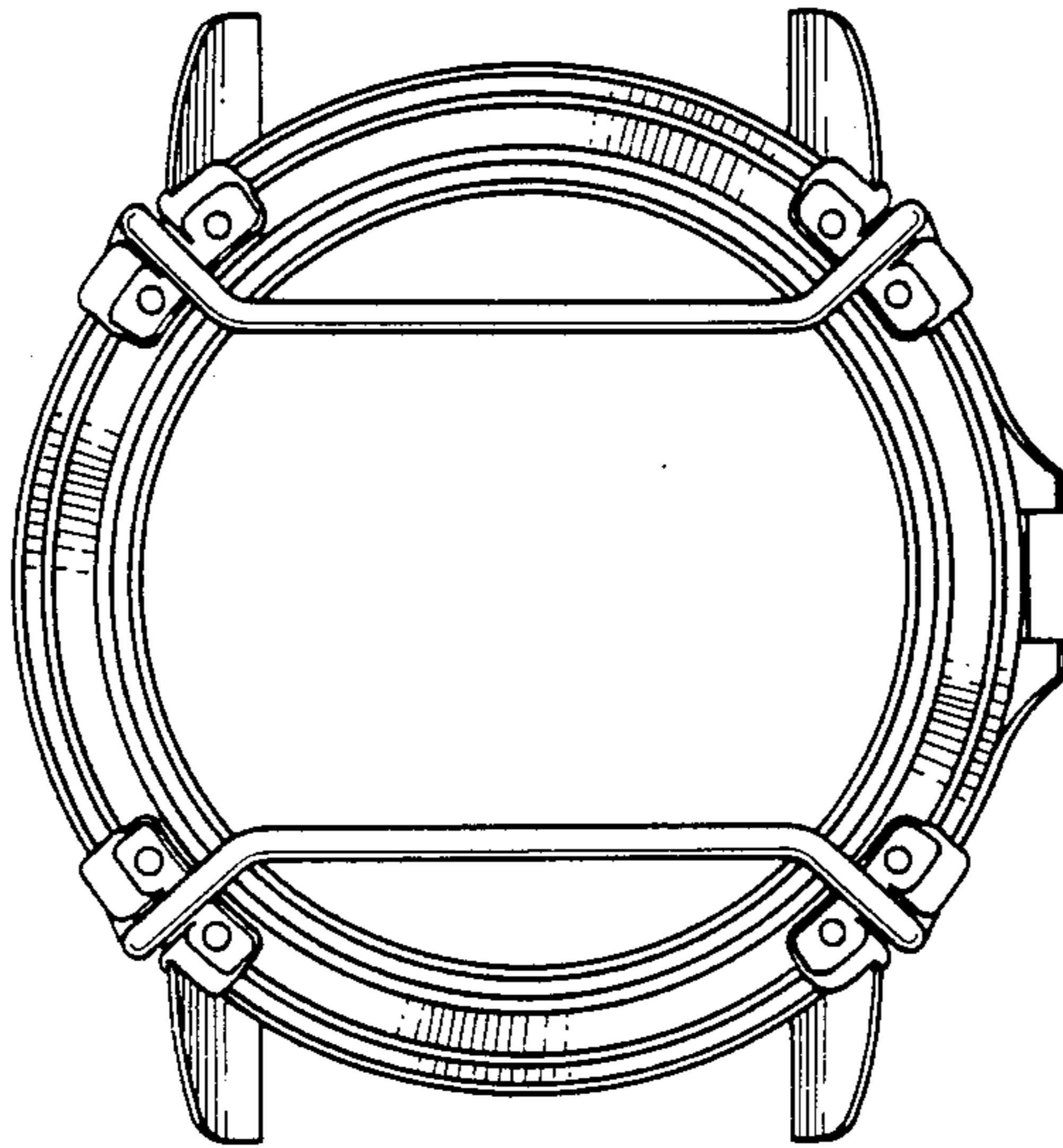

FIG. 3

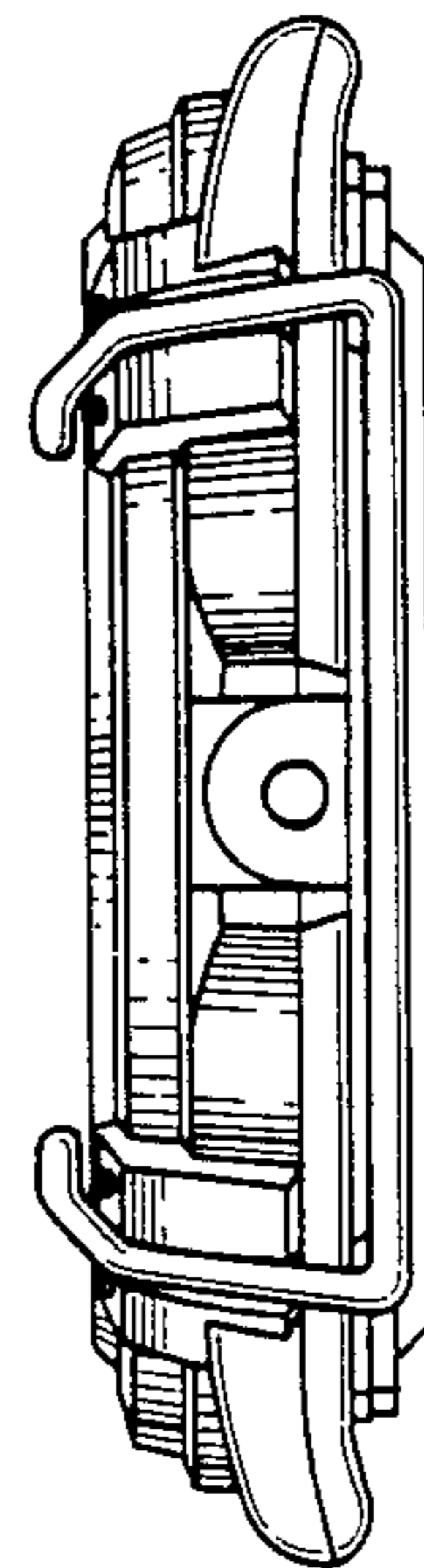

FIG. 5

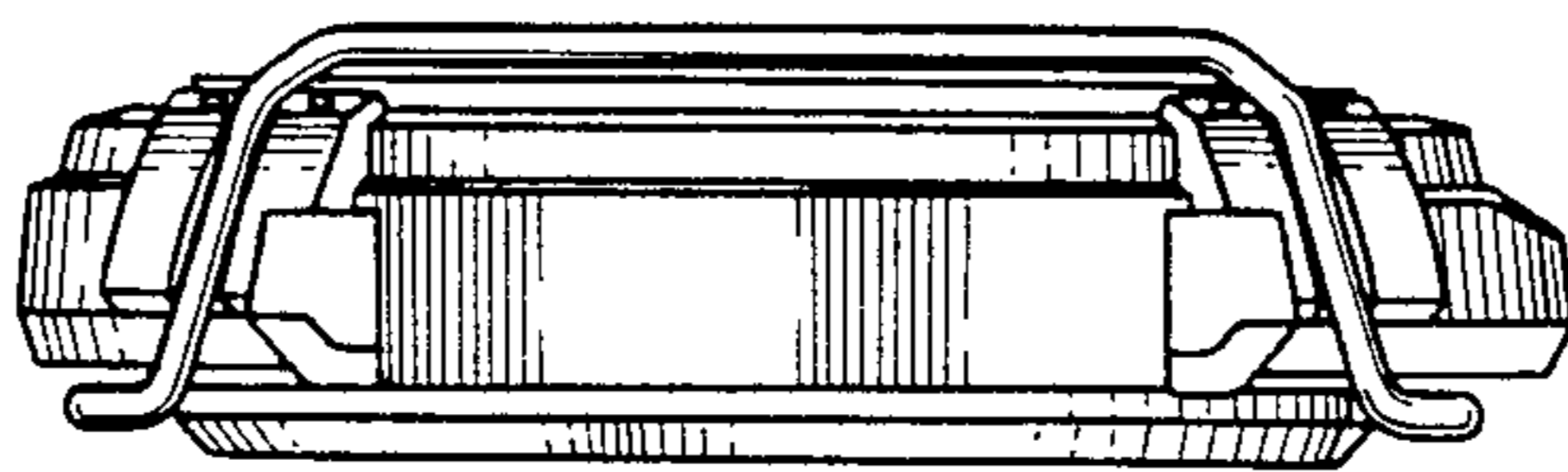

FIG. 6

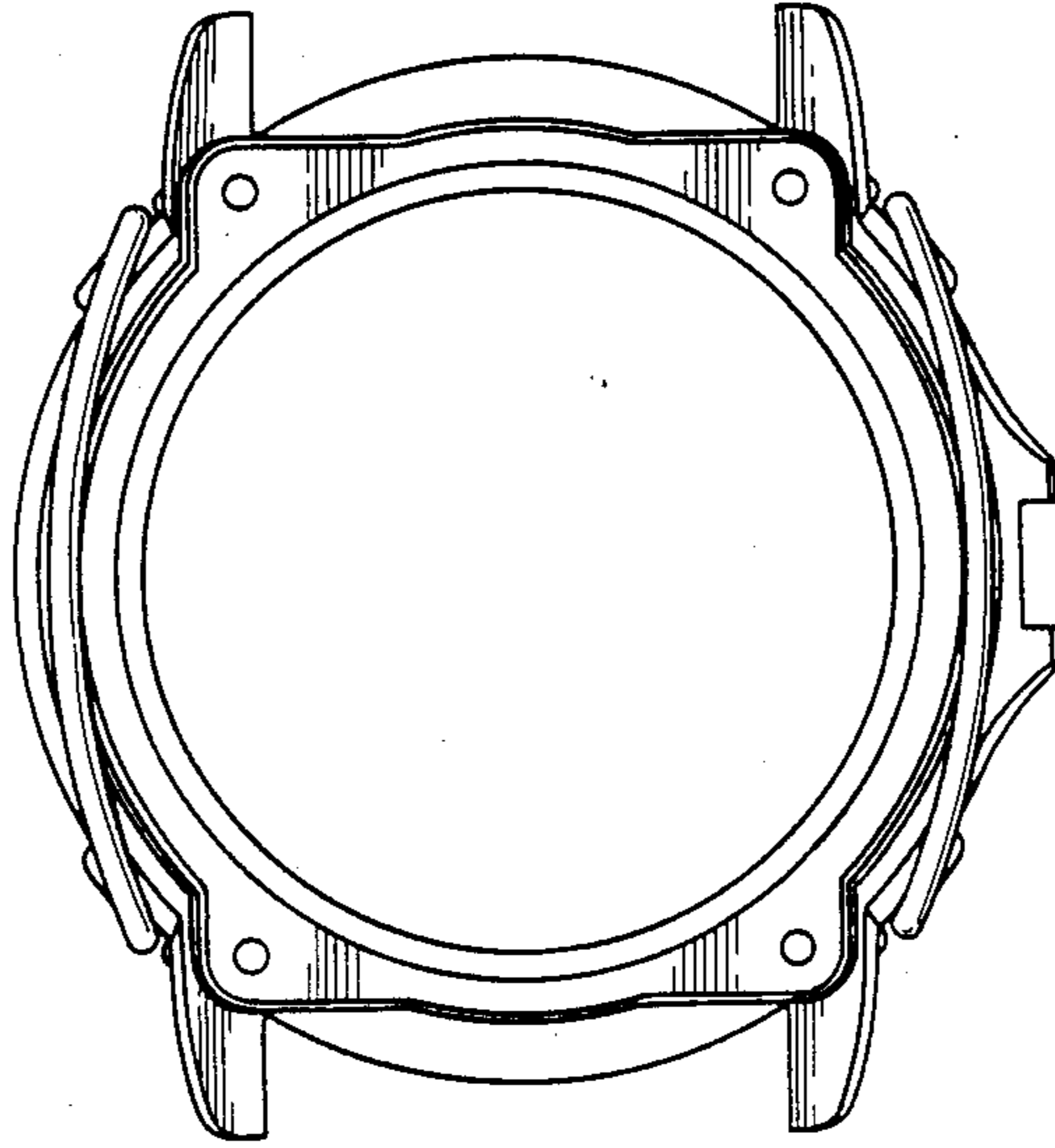

FIG. 7

