

[54] **ARMCHAIR**

[75] **Inventors:** Hans von Klier, Milan, Italy; Fredi Dubach, Bäretswil, Switzerland
[73] **Assignee:** Drabert Sohne GmbH & Co., Minden, Fed. Rep. of Germany

[**] **Term:** 14 Years

[21] **Appl. No.:** 82,716

[22] **Filed:** Aug. 7, 1987

[30] **Foreign Application Priority Data**

Feb. 12, 1987 [DE] Fed. Rep. of Germany 6a AR 12/87

[52] **U.S. Cl.** D6/366

[58] **Field of Search** D6/366, 334

[56] **References Cited**

U.S. PATENT DOCUMENTS

D. 274,769 7/1984 Klier D6/366
D. 275,430 9/1984 Ochsner D6/366
D. 290,193 6/1987 Harter et al. D6/366

OTHER PUBLICATIONS

Interiors, Dec. 1984, p. 21, Chair, left center.
Interiors, Feb. 1985, p. 131, Chair, right top corner.
Interiors, May 1985, p. 47, Chair, right center.
Interiors, Jun. 1985, p. 39, Chair.

Primary Examiner—Bruce W. Dunkins
Assistant Examiner—Ann Hunt
Attorney, Agent, or Firm—Pollock, Vande Sande and Priddy

[57] **CLAIM**

The ornamental design for an armchair, as shown and described.

DESCRIPTION

FIG. 1 is a front elevational view of the armchair showing our new design;
FIG. 2 is a left side elevational view, the right side elevational view being a mirror image thereof;
FIG. 3 is a rear elevational view;
FIG. 4 is a top plan view;
FIG. 5 is a bottom plan view; and
FIG. 6 is a perspective view thereof.

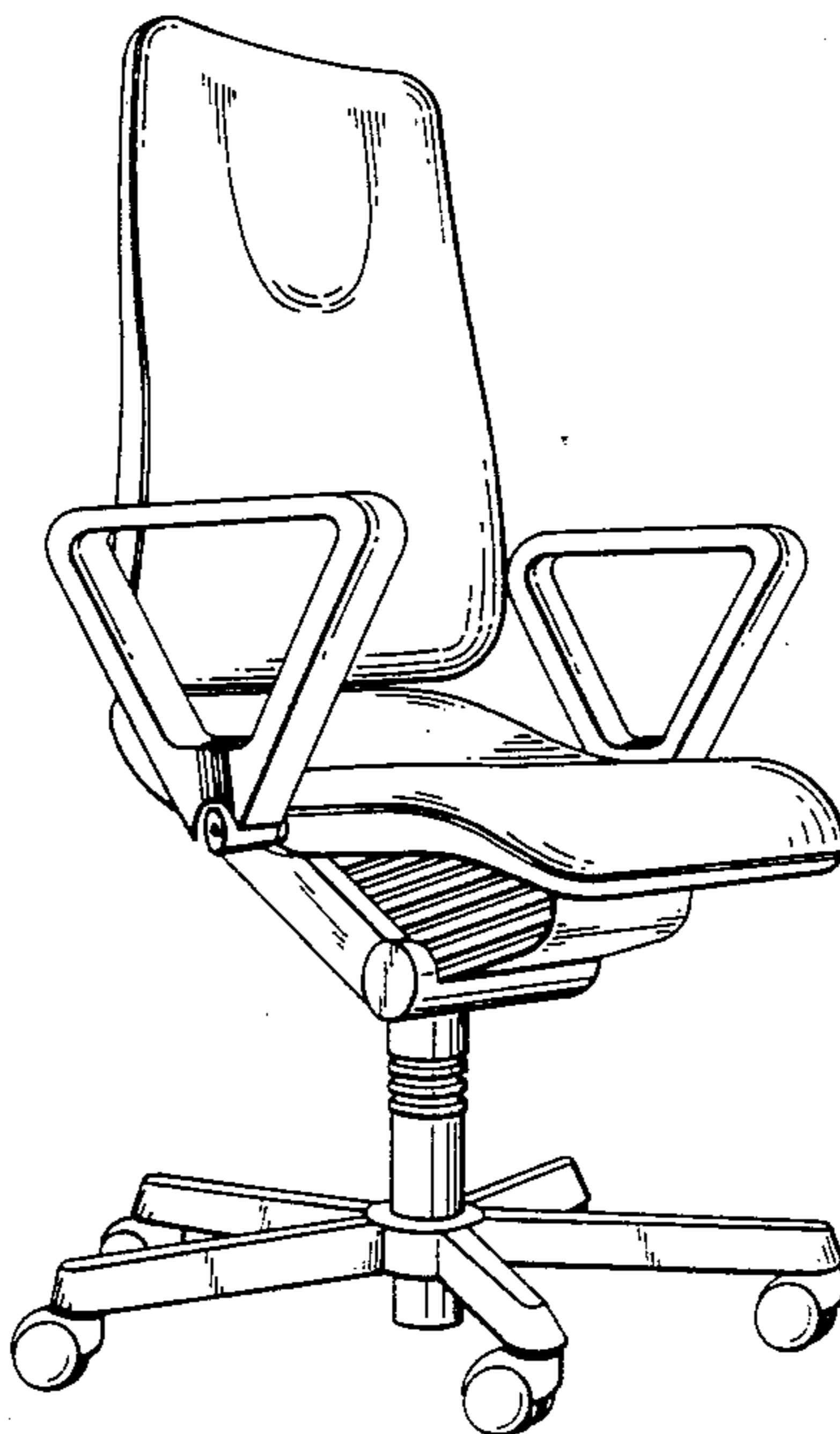

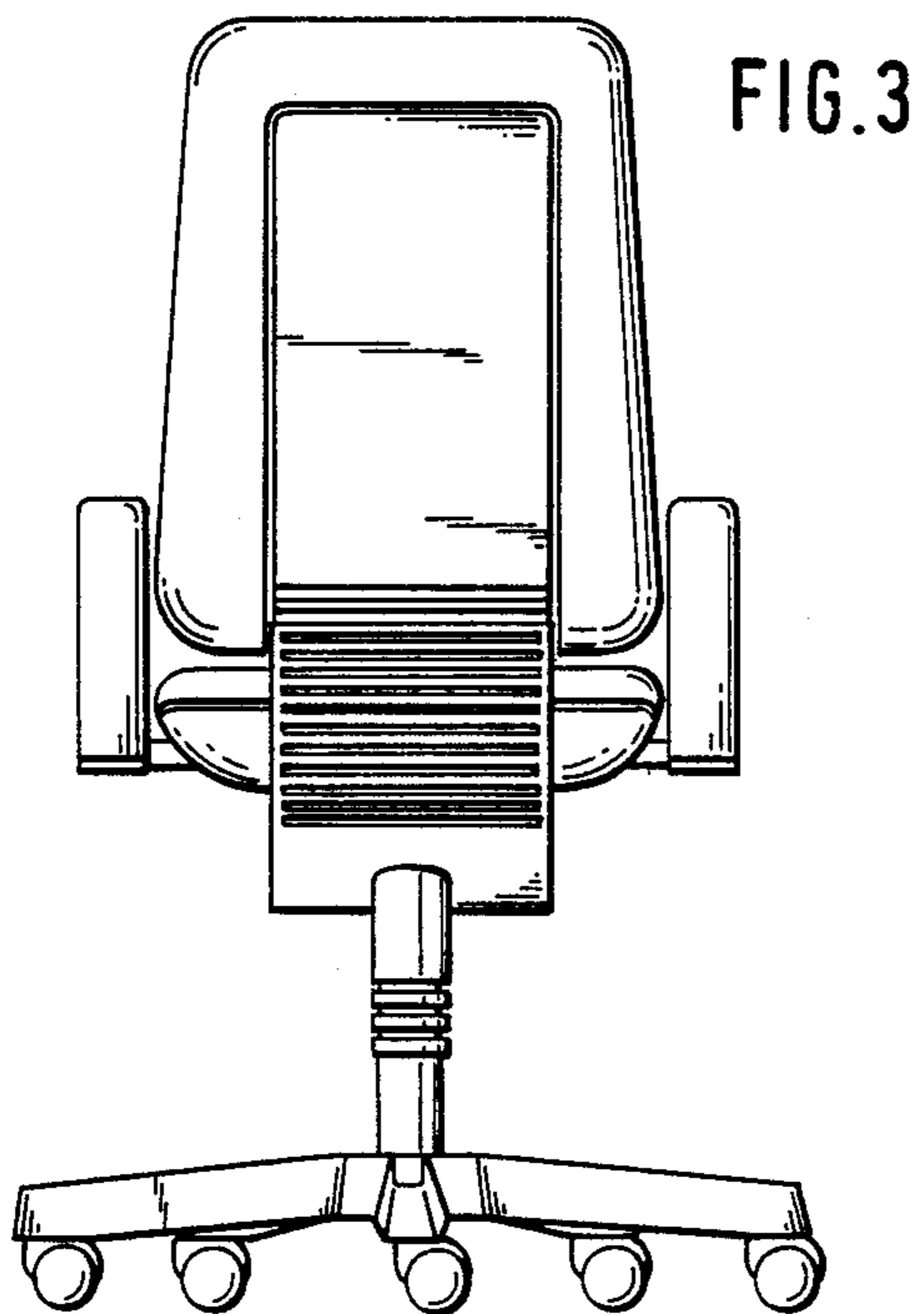
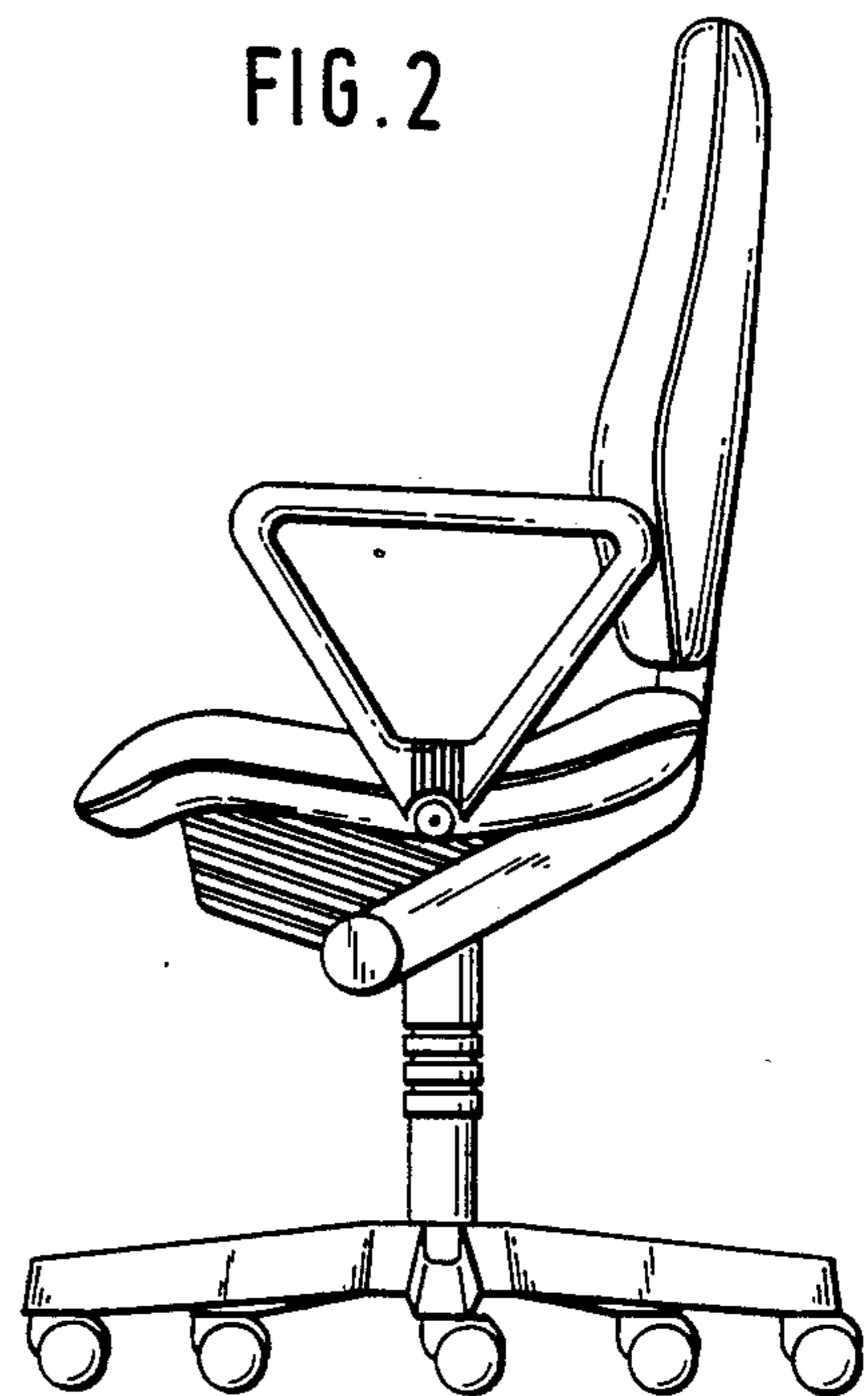
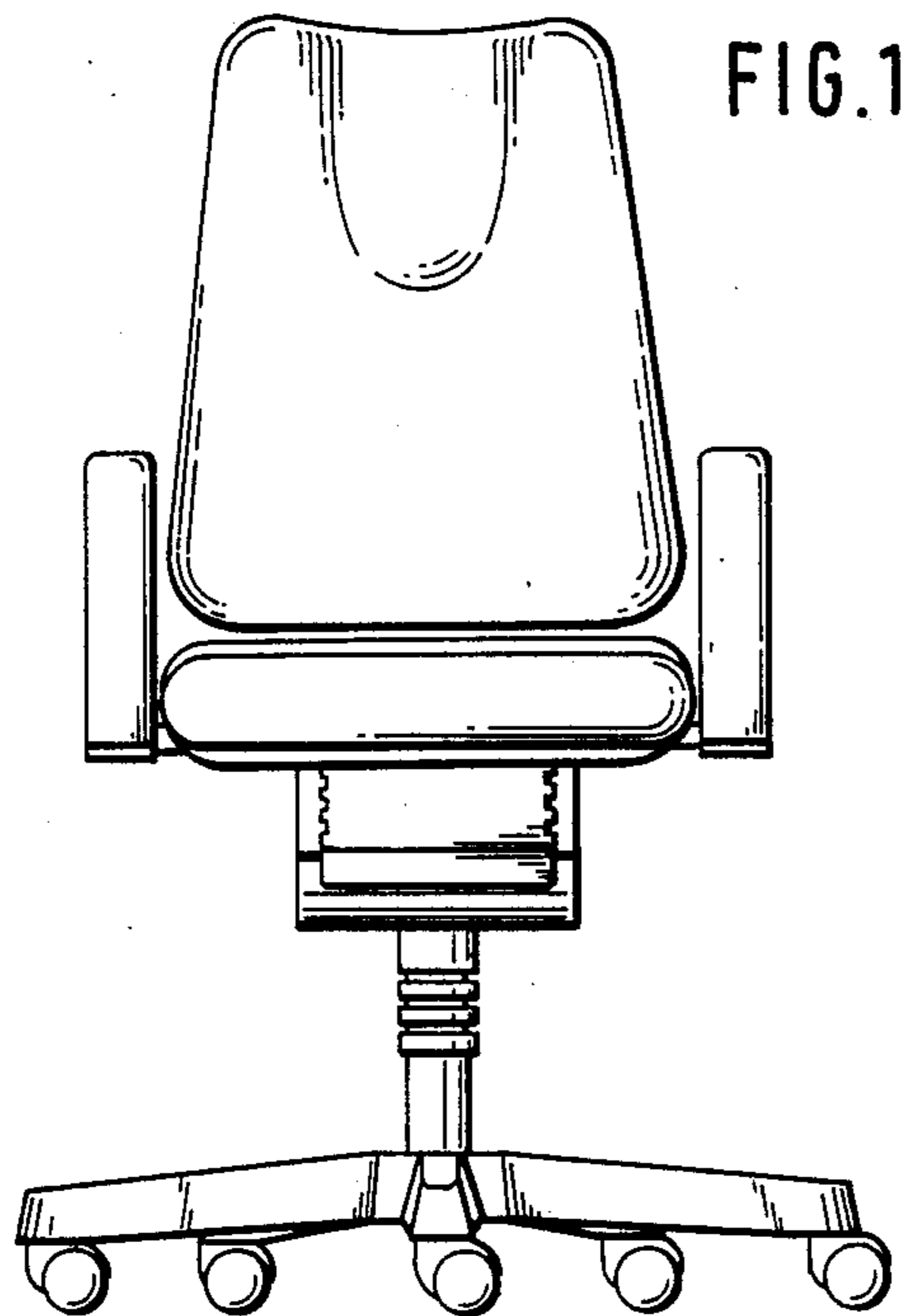

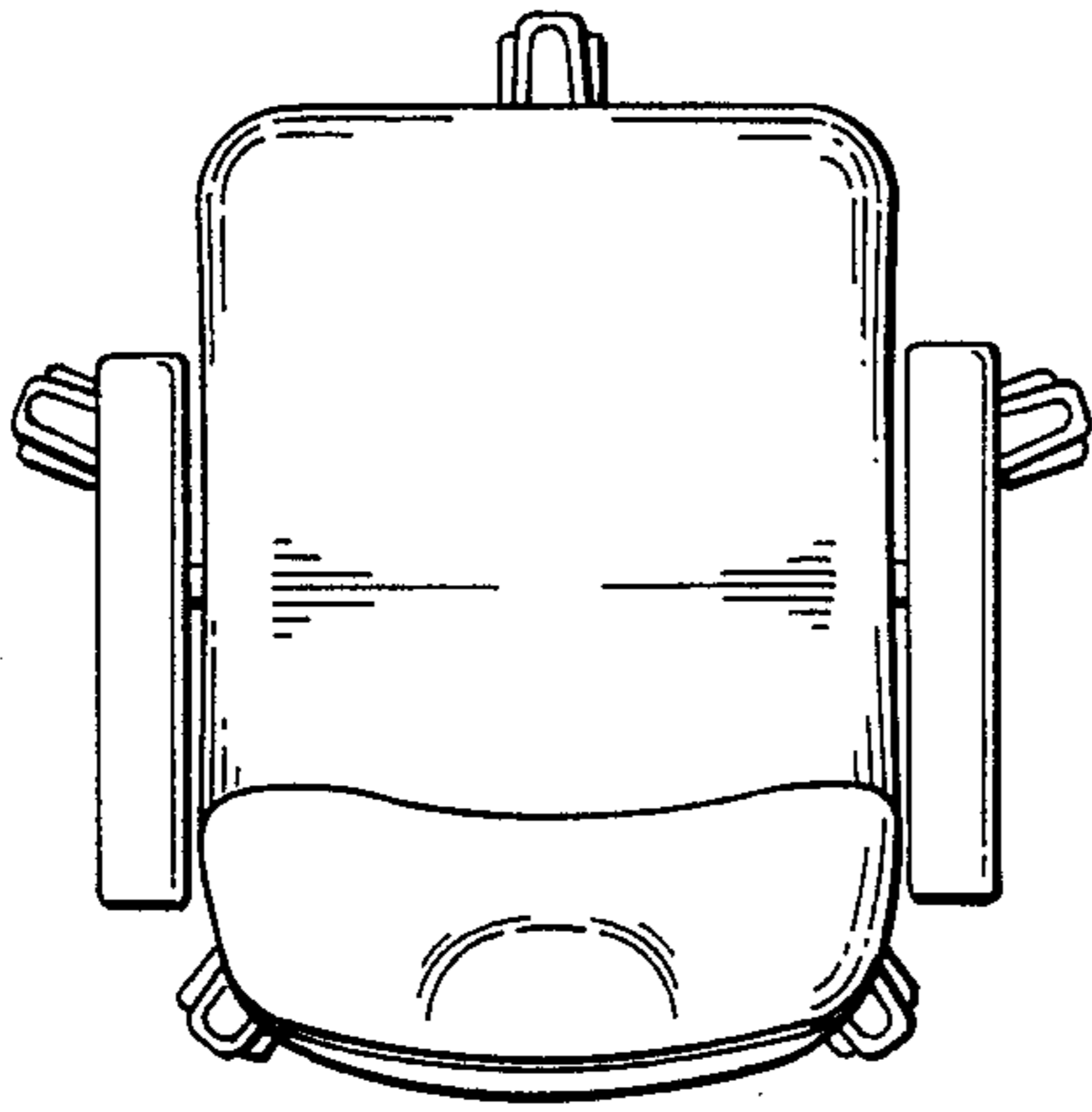

FIG. 4

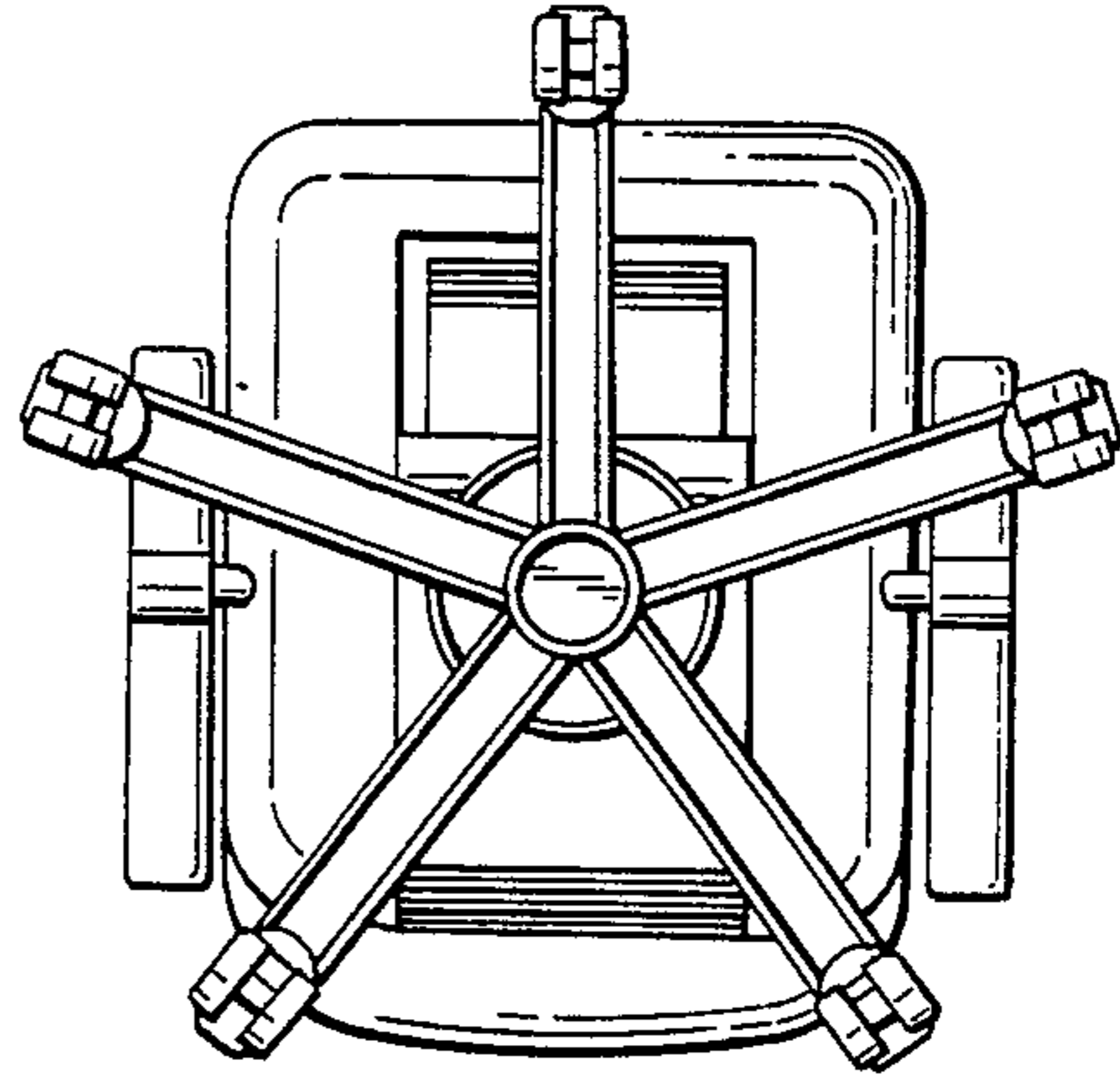

FIG. 5

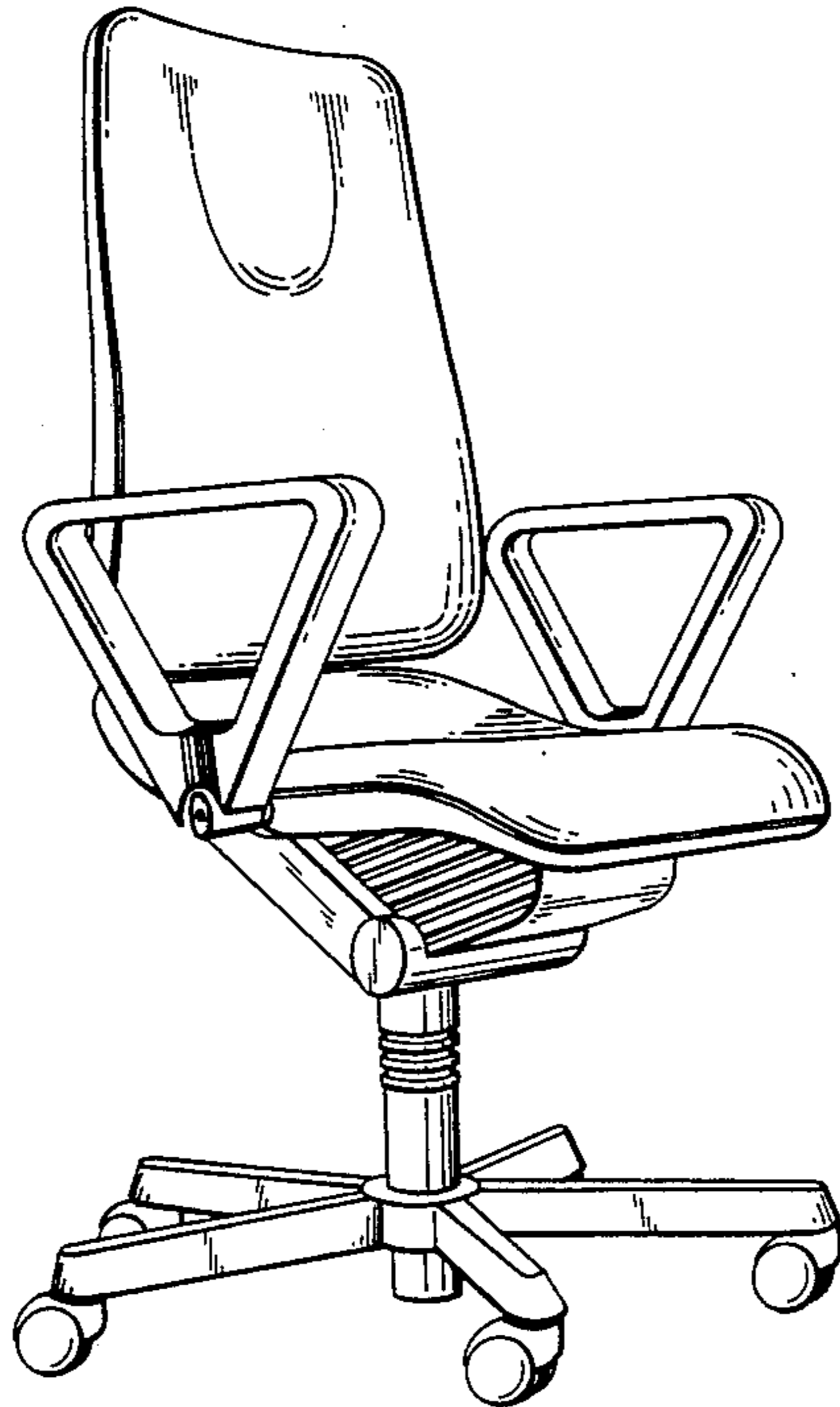

FIG. 6