

[54] **WALL LAMP**

[75] **Inventor: Gianfranco Frattini, Milan, Italy**

[73] **Assignee: ARTEMIDE S.p.A., Milan, Italy**

[**] **Term: 14 Years**

[21] **Appl. No.: 114,268**

[22] **Filed: Oct. 29, 1987**

[30] **Foreign Application Priority Data**

Apr. 29, 1987 [IT] Italy 21489/87[U]

[52] **U.S. Cl. D26/87**

[58] **Field of Search D26/72, 80-92,
D26/105; 362/432, 404-408, 147, 362**

[56] **References Cited**

U.S. PATENT DOCUMENTS

D. 270,483 9/1983 Gardner et al. D26/105 X

D. 288,136 2/1987 Pfister D26/87

OTHER PUBLICATIONS

Stilnovo Catalog #57/84, p. 10, Wall Lamp #15031, "PADA".

Primary Examiner—Susan J. Lucas

Attorney, Agent, or Firm—Guido Modiano; Albert Josif

[57] **CLAIM**

The ornamental design for wall lamp, as shown.

DESCRIPTION

FIG. 1 is a top, front perspective view of a wall lamp showing my new design;

FIG. 2 is a right side elevational view thereof;

FIG. 3 is a left side elevational view thereof;

FIG. 4 is a top plan view thereof;

FIG. 5 is a bottom plan view thereof;

FIG. 6 is a front elevational view thereof;

FIG. 7 is a rear elevational view thereof.

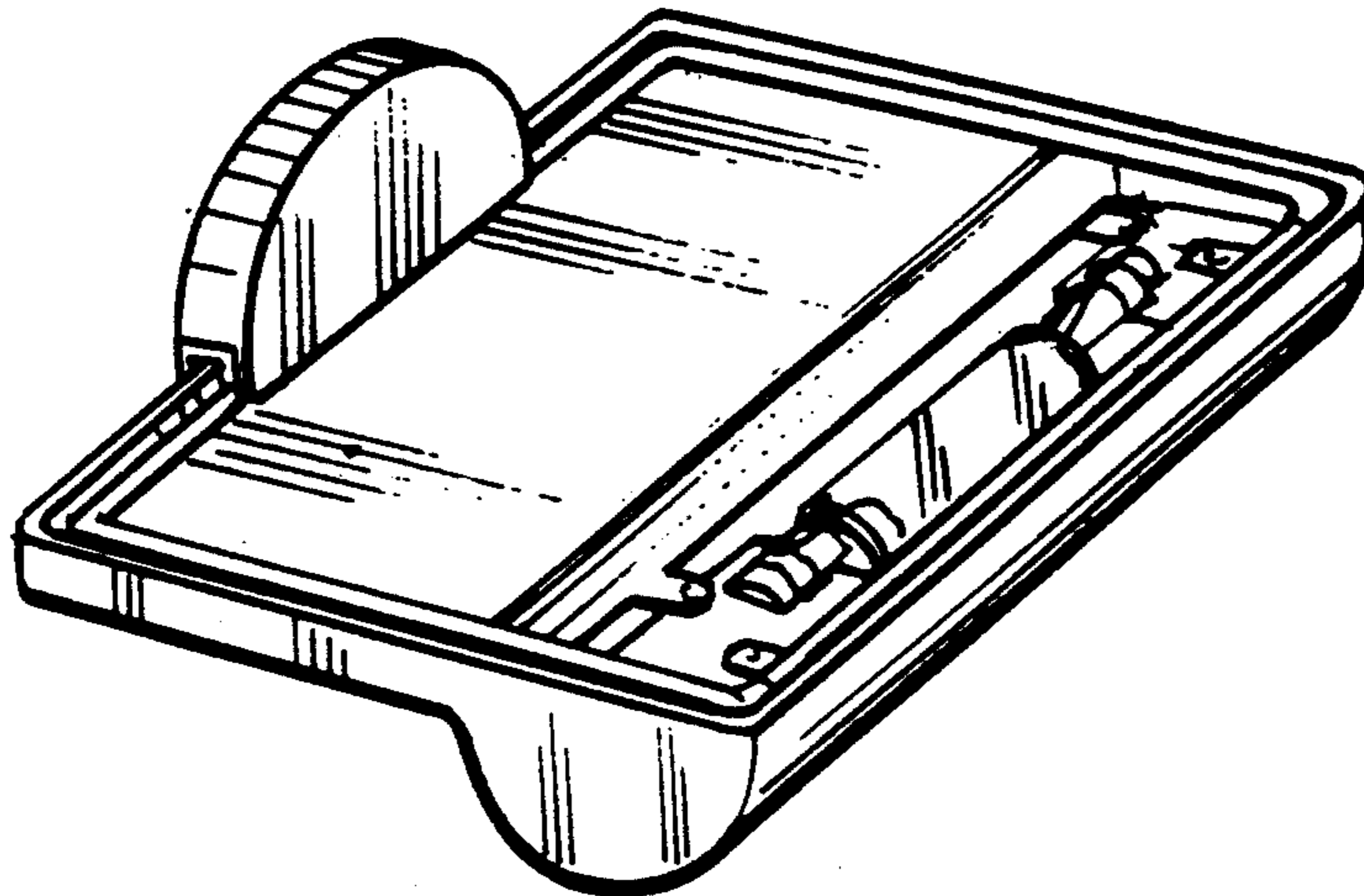

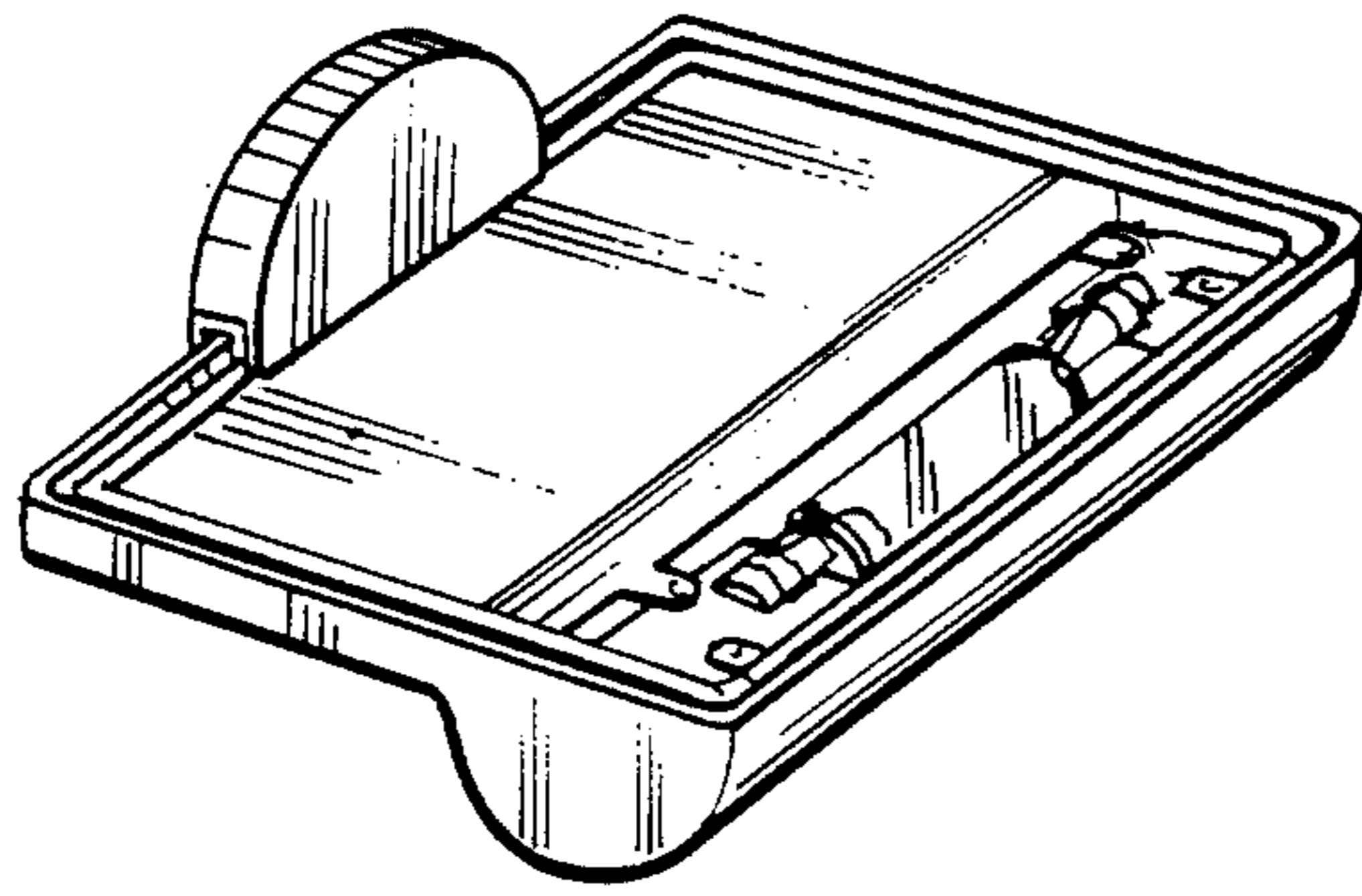

Fig. 1

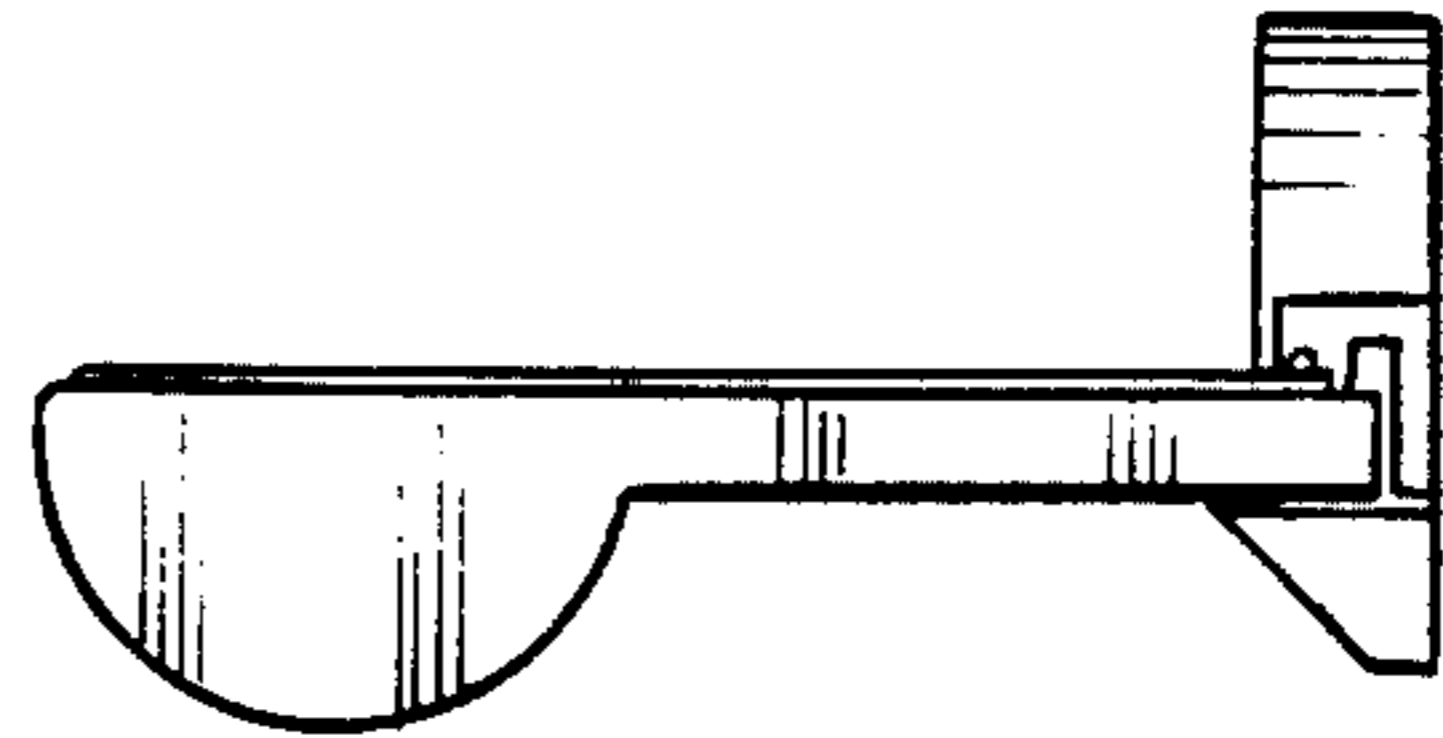

Fig. 2

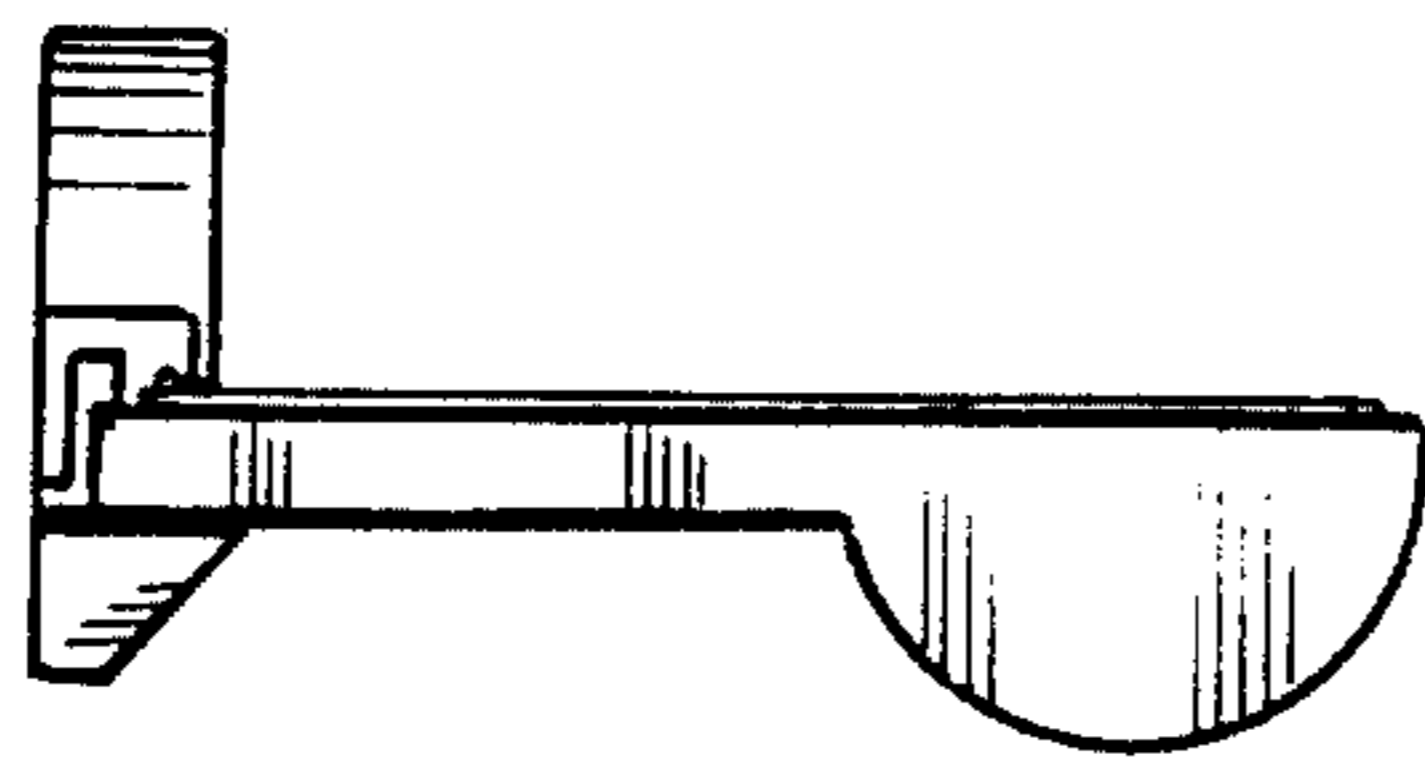

Fig. 3

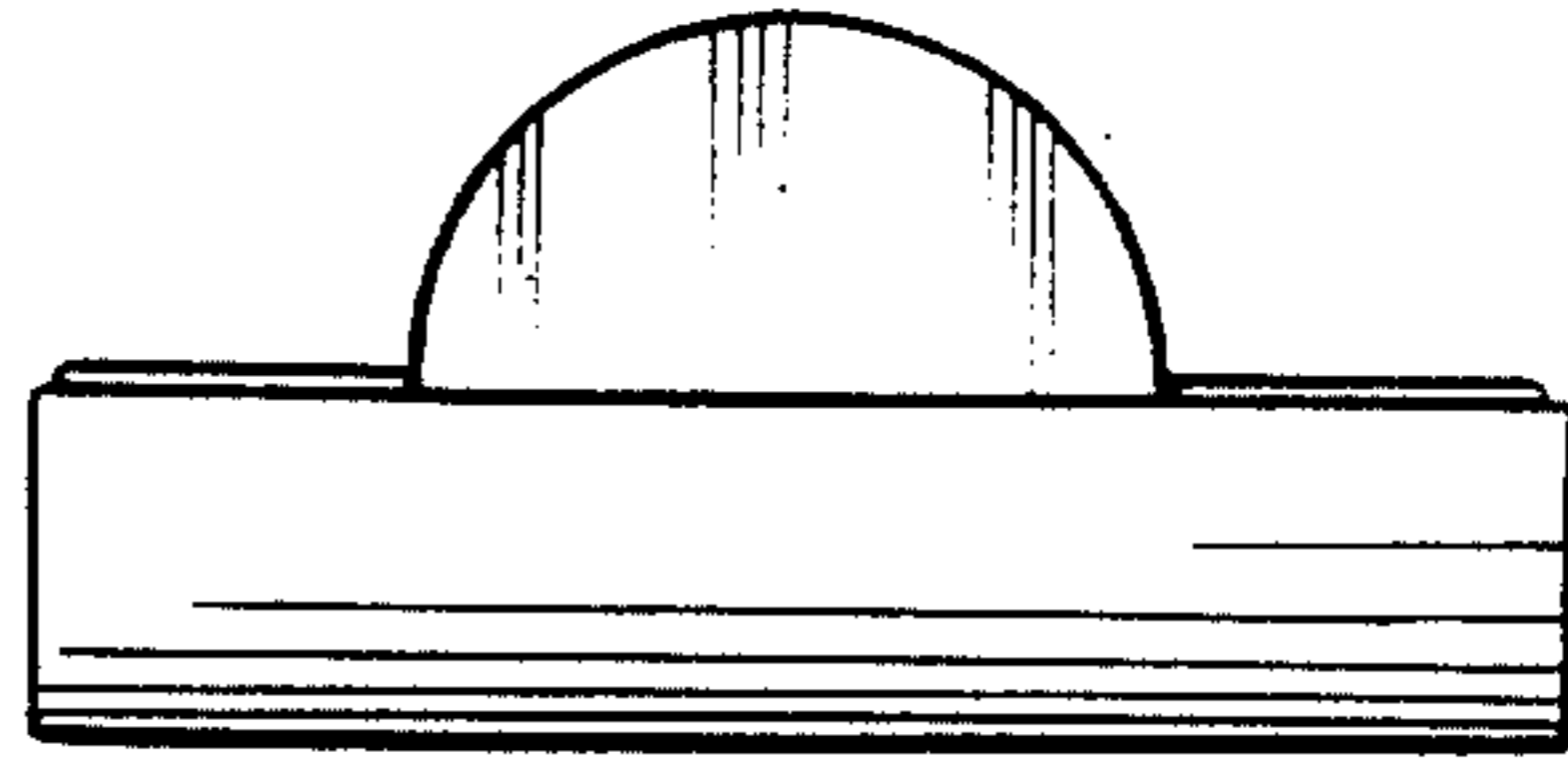

Fig. 6

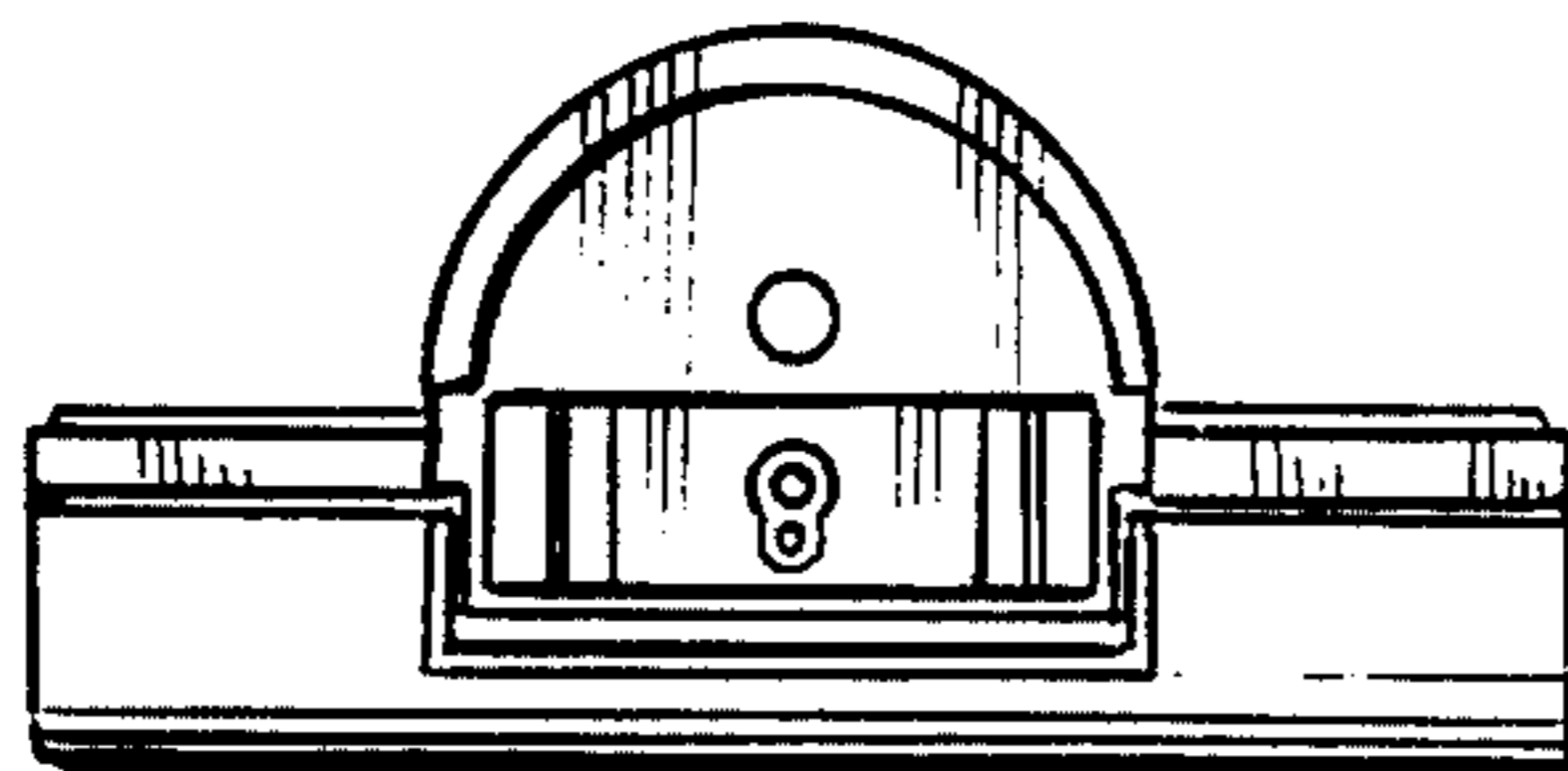

Fig. 7

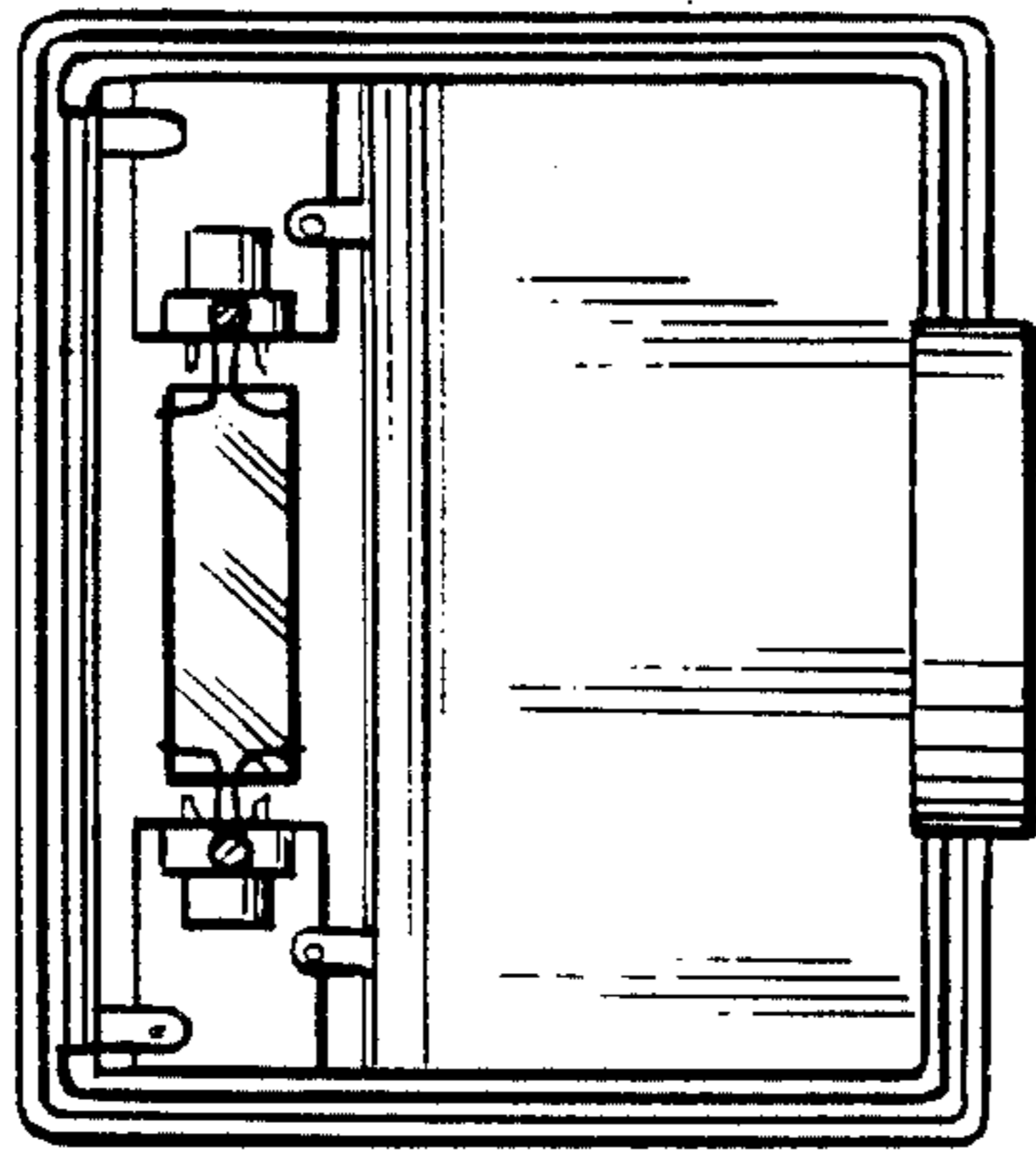

Fig. 4

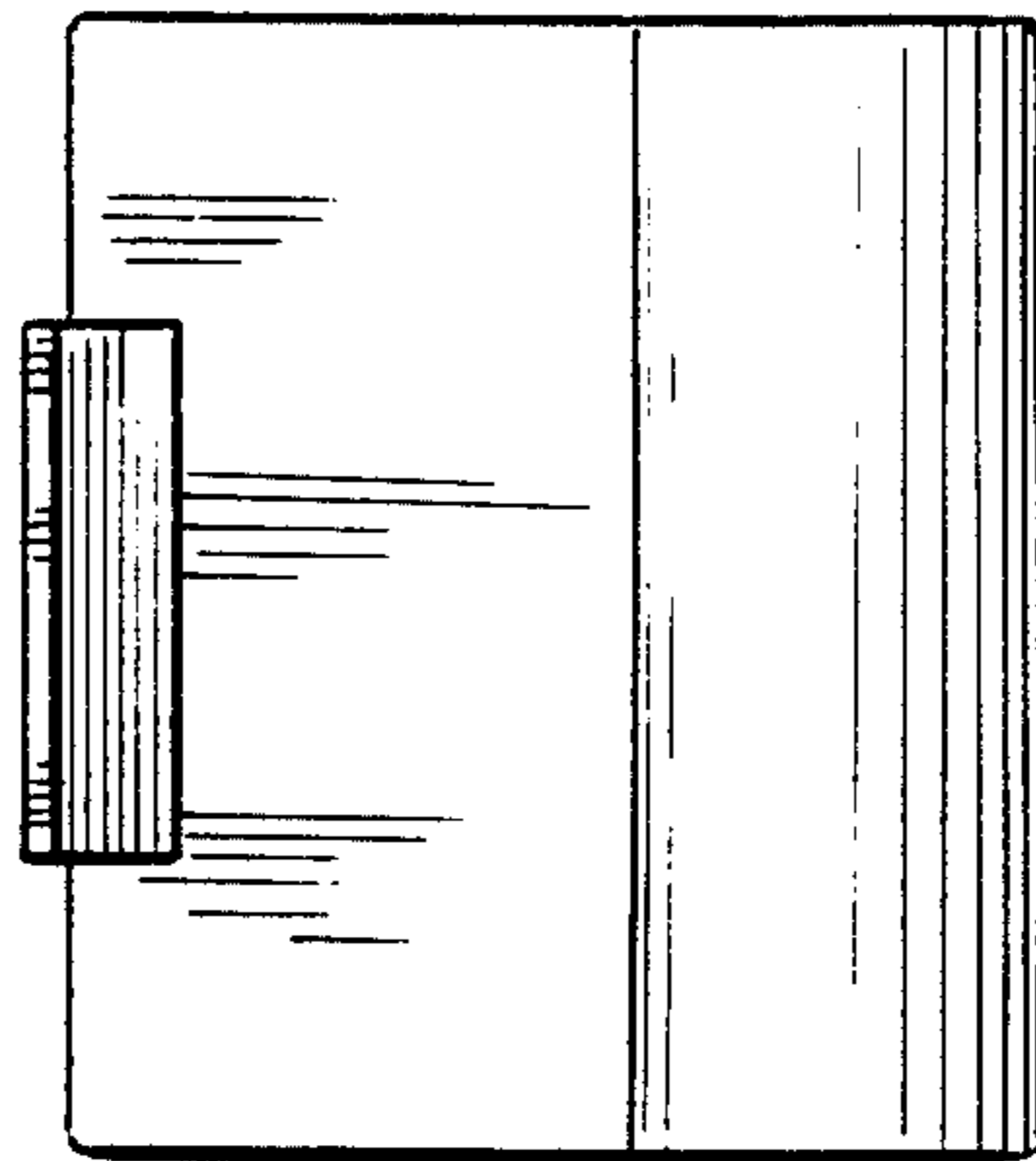

Fig. 5