

[54] TELEPHONE HOUSING

[76] Inventor: Walter W. Yuan, 3900 E. Whiteside St., Los Angeles, Calif. 90063

[**] Term: 14 Years

[21] Appl. No.: 111,974

[22] Filed: Oct. 21, 1987

[52] U.S. Cl. D14/150

[58] Field of Search D14/53; 379/440, 436, 379/434, 435, 428, 419, 433

[56] References Cited

U.S. PATENT DOCUMENTS

D. 179,778	2/1957	Pruss et al.	D14/53
D. 256,234	8/1980	Fukushima et al.	D14/53
D. 264,678	4/1982	Fukushima et al.	D14/53
D. 286,777	11/1986	Bishop	D14/53 X
D. 292,703	11/1987	Tragtsching	D14/53
D. 293,103	12/1987	Gauffin et al.	D14/53
D. 293,571	1/1988	Büchin	D14/53
D. 294,695	3/1988	Endt	D14/53
D. 297,137	8/1988	Richter et al.	D14/53 X

OTHER PUBLICATIONS

Best & Co. ©1986 Item Nos. 15, 16, 12, 11, 10 on p. 297; Items 5 and 6.

B. A. Pargh, 1987 Catalog, Pactel p. 282; Siemens p. 282; at page 287, Teleguest Items; p. 289, Cobra at p. 291, Panasonic.

Primary Examiner—Horace B. Fay, Jr.

Attorney, Agent, or Firm—Danton K. Mak

[57] CLAIM

The ornamental design for a telephone housing, as shown and described.

DESCRIPTION

FIG. 1 is a top and right side perspective view of a telephone housing showing my new design; FIG. 2 is a front elevational view thereof; FIG. 3 is a top plan view thereof; FIGS. 4 and 5 are respectively right and left side elevational views thereof; FIG. 6 is a rear elevational view thereof; and FIG. 7 is a bottom plan view thereof.

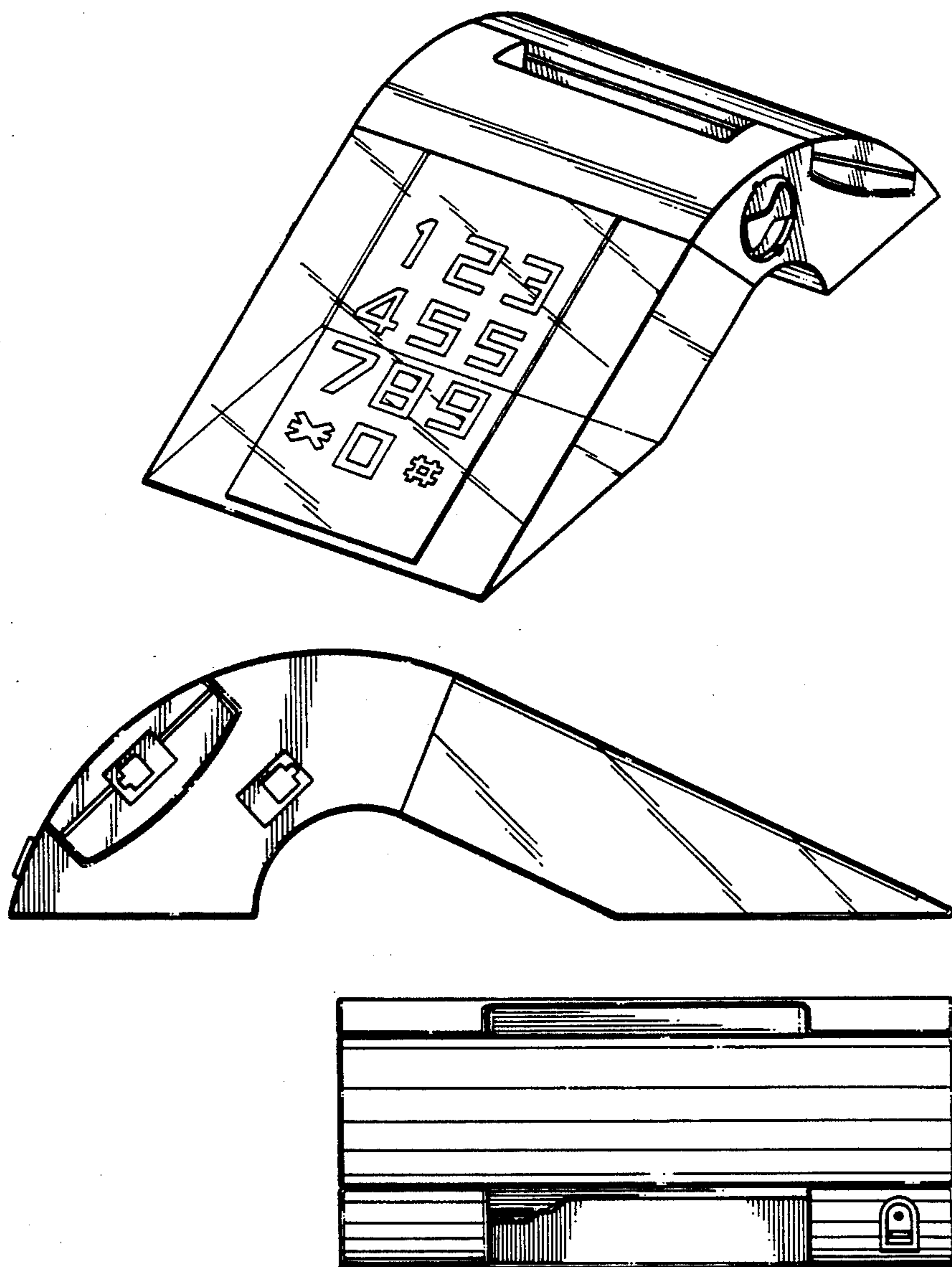

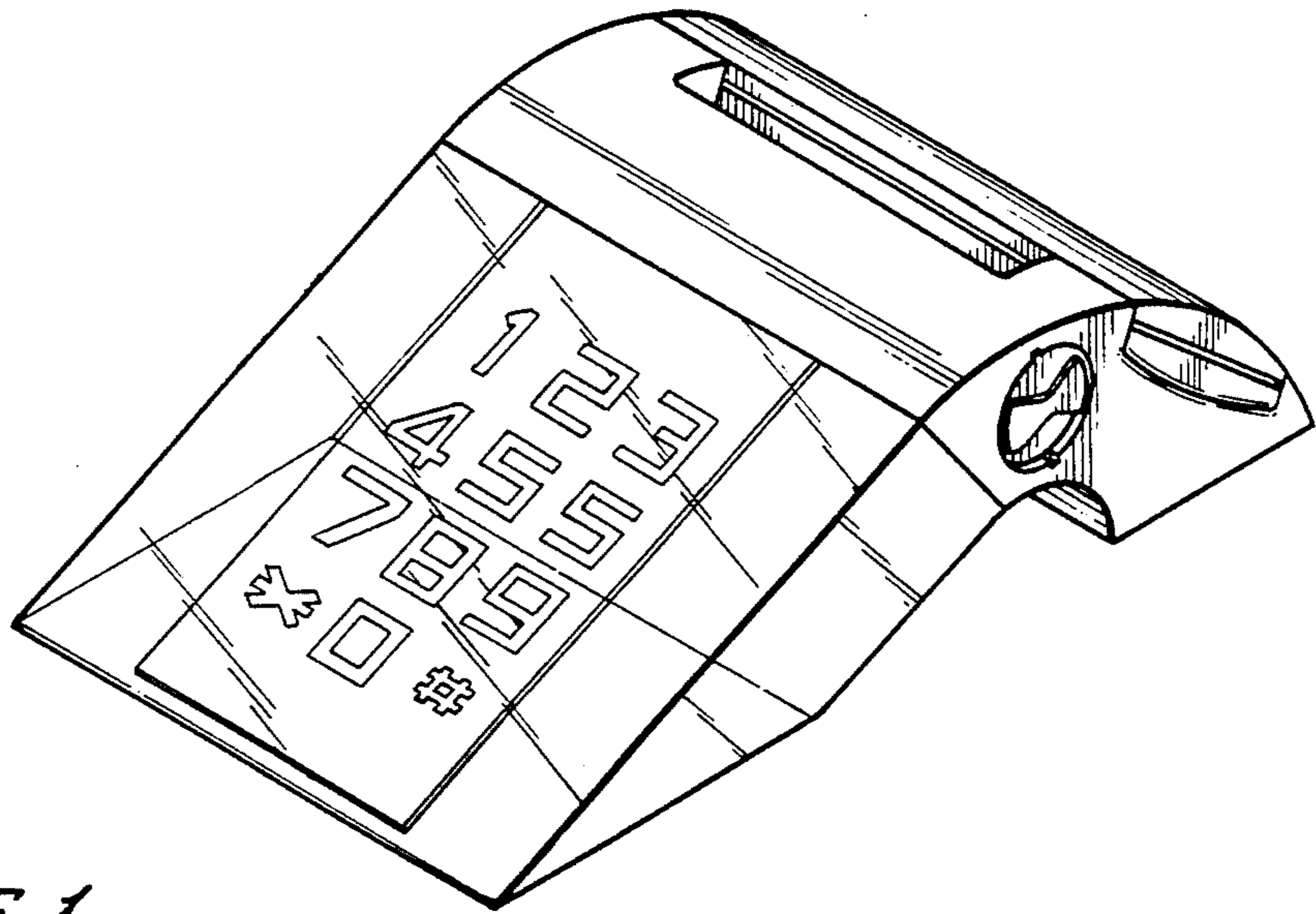

FIG. 1.

FIG. 2.

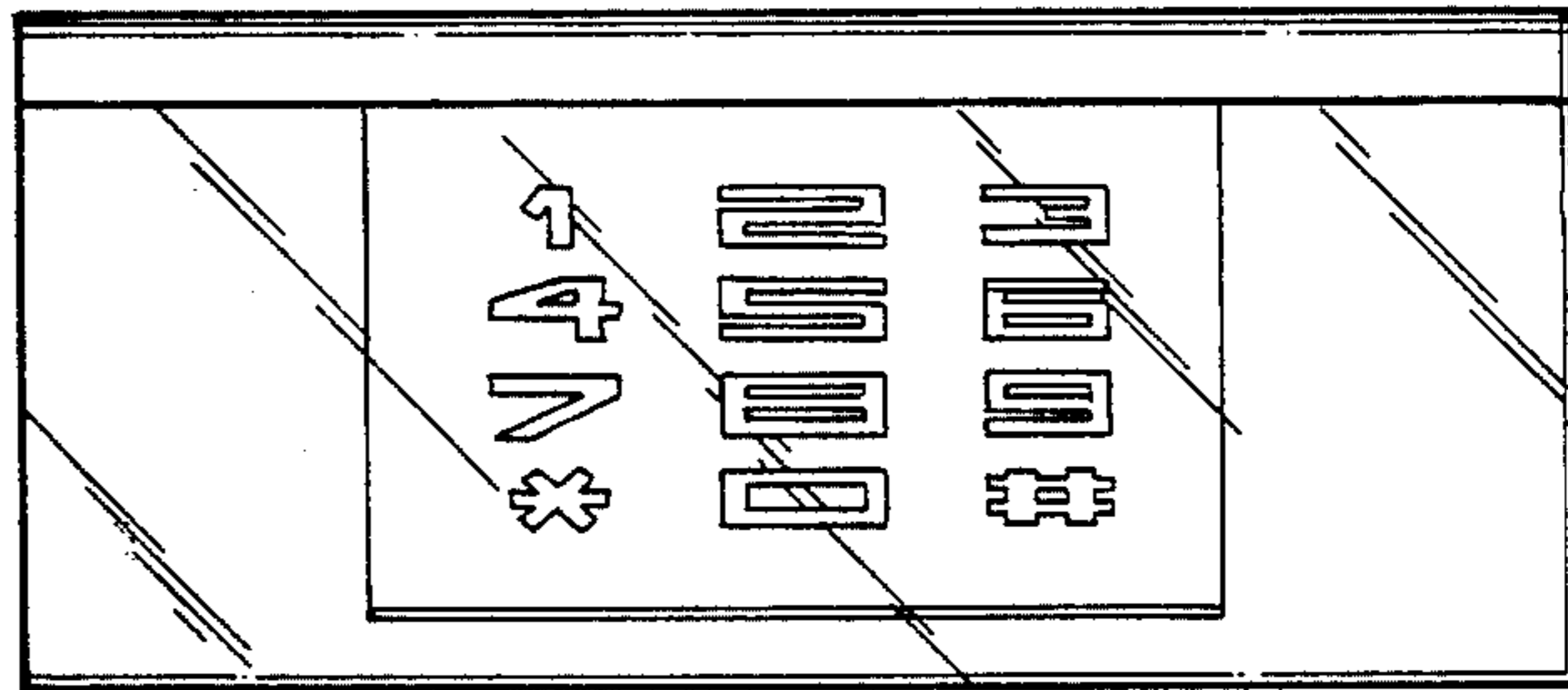

FIG. 3.

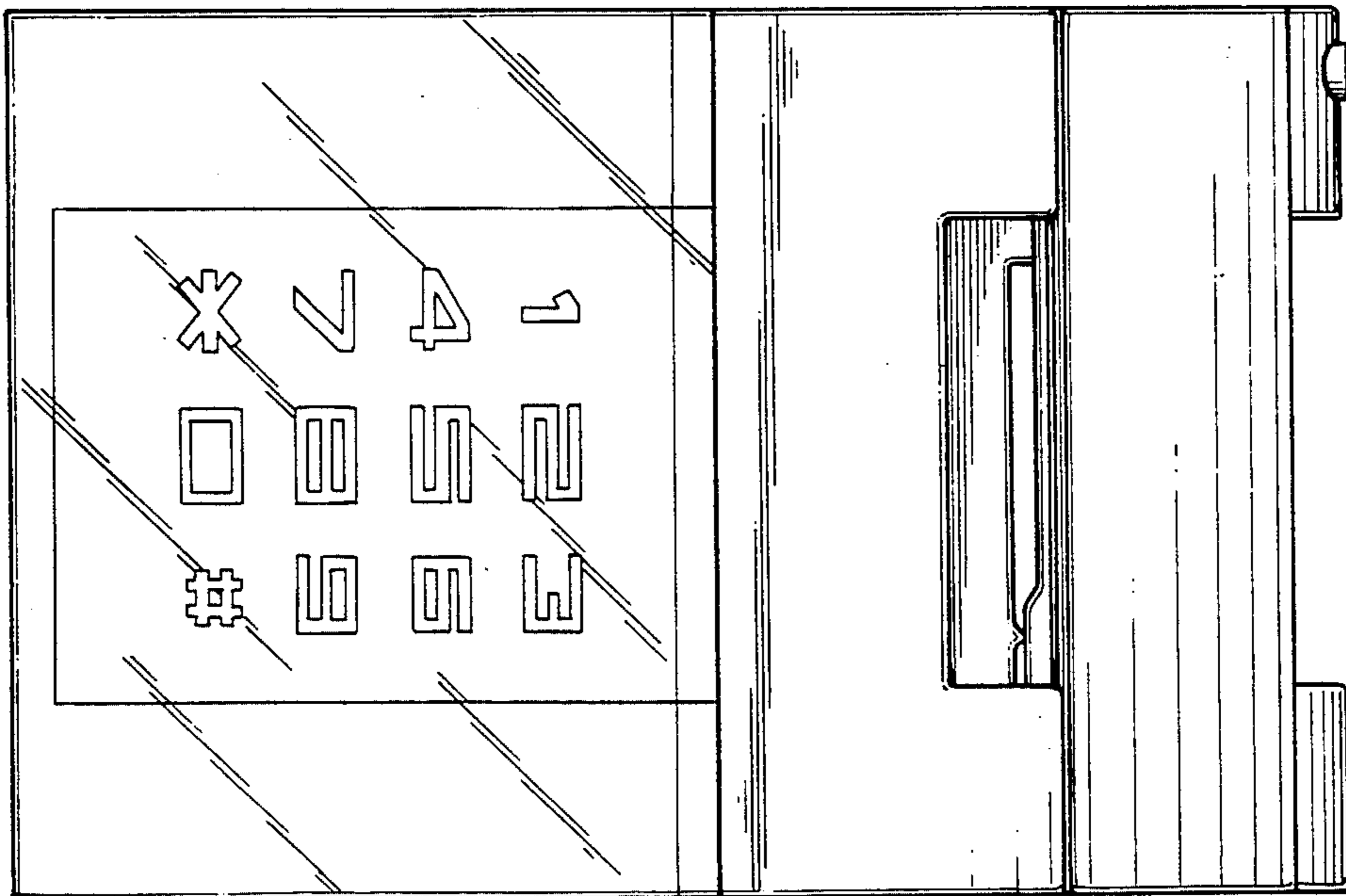

FIG. 4

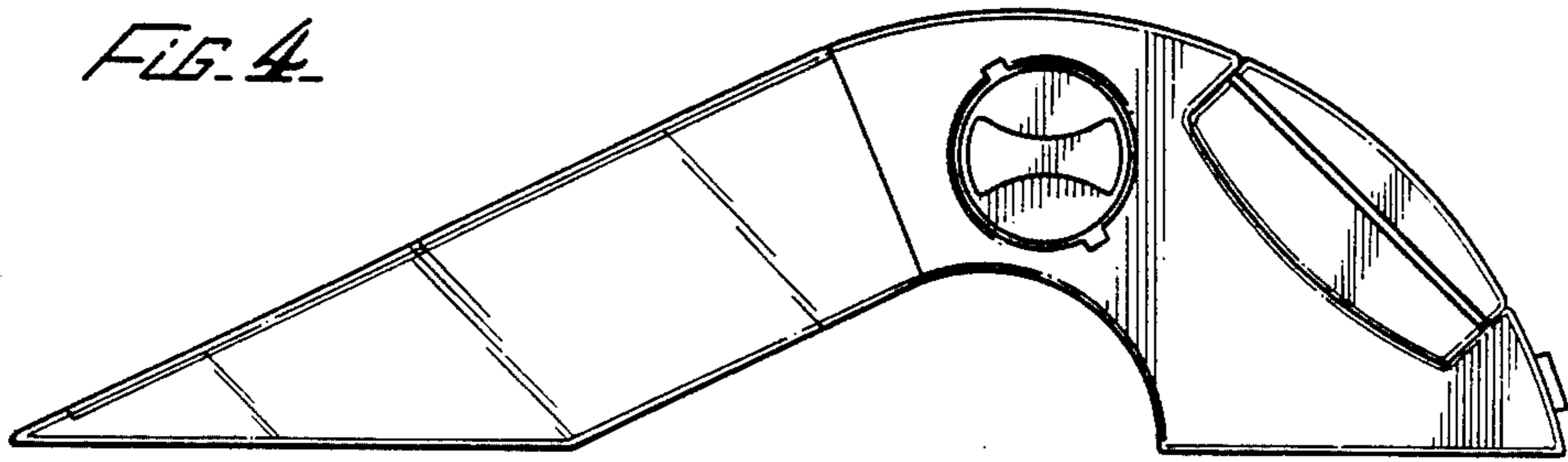

FIG. 5

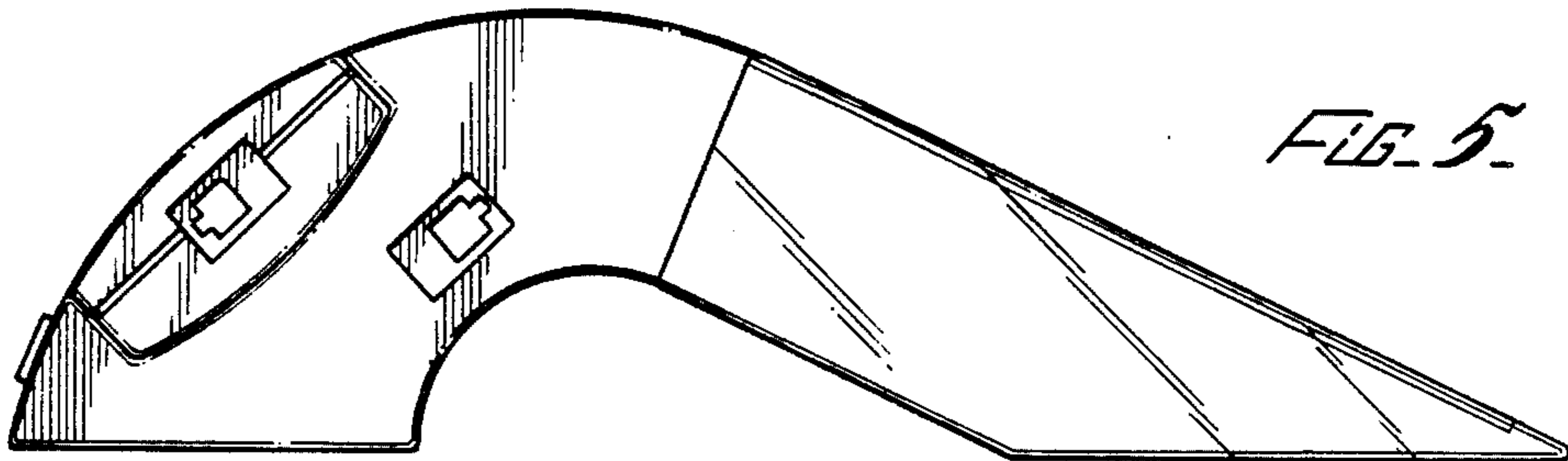

FIG. 6

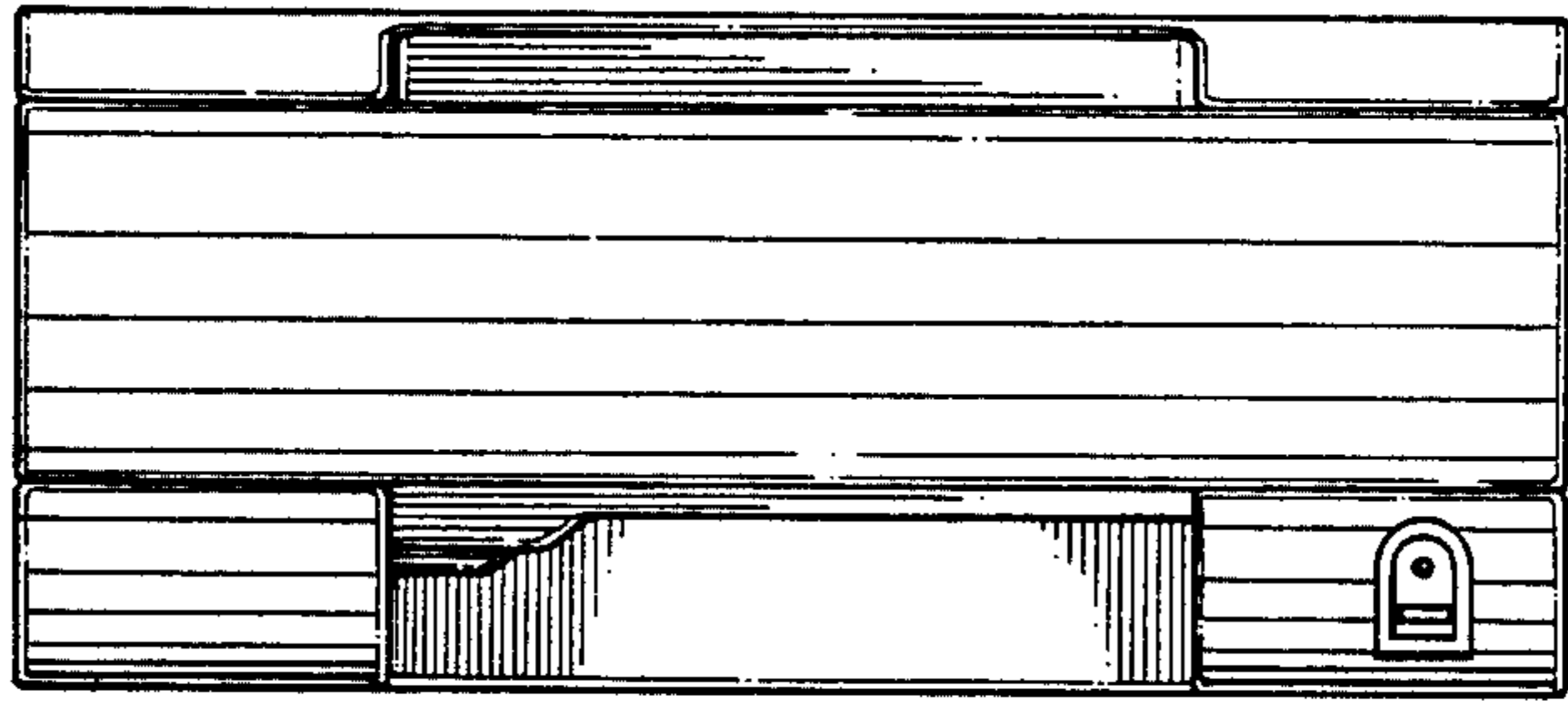

FIG. 1

