

[54] **PLATE OR SIMILAR ARTICLE**
 [75] **Inventor:** Hans-Wilhelm Seitz, Marktredwitz,
 Fed. Rep. of Germany
 [73] **Assignee:** Porzellanfabrik Weiden Gebr.
 Bauscher Zweigniederlassung der
 Hutschenreuther Aktiengesellschaft,
 Weiden, Fed. Rep. of Germany

[**] **Term:** 14 Years

[21] **Appl. No.:** 907,756

[22] **Filed:** Sep. 11, 1986

[30] **Foreign Application Priority Data**

Mar. 13, 1986 [DE] Fed. Rep. of Germany ... MR V7654

[52] **U.S. Cl.** D7/585

[58] **Field of Search** D7/23, 27, 1, 3, 28,
 D7/33-35, 29, 20, 45, 39, 36, 30-32

[56] **References Cited**

U.S. PATENT DOCUMENTS

D. 19,741	4/1890	Pouyat	D7/37	X
D. 38,870	11/1907	Walter	D7/34	
D. 97,442	11/1935	Slobodkin	D7/33	
D. 103,256	2/1937	Trarieux	D7/34	
D. 107,064	11/1937	Broomhall	D7/33	
D. 283,664	5/1986	Murai	D7/30	
D. 283,665	5/1986	Murai	D7/30	
3,190,484	6/1965	Mount	D7/23	X

OTHER PUBLICATIONS

Atlas-Globe China Catalog, 5/27/1927, p. 10, "Santa Maria Shape", Saucer #29, Plate #24 and #10.
Rosenthal "Duo", Printed 10-75, Folder, Exotic Yellow Striped Pattern Shown, Design Rosemonde Nairac/-Shape by Ambrogio Pozzlo shown.
Interiors, Oct. 1973, p. 24, Syracuse China "Spectrum". Concentric Circles Swirl Around Rims of Plates top left panel.

Premium Practice, Jan. 1938, p. 33, Dinnerware by Sebring, "The Aristocrat" Stripes on Plates.

Primary Examiner—Winifred E. Herrmann
Attorney, Agent, or Firm—Jordan and Hamburg

[57] **CLAIM**

The ornamental design for a plate or similar article, as shown and described.

DESCRIPTION

FIG. 1 is a side elevational view of a plate or similar article showing one embodiment of my new design;
 FIG. 2 is a top plan view thereof;
 FIG. 3 is a bottom plan view thereof;
 FIG. 4 is a cross-sectional view thereof taken along the line 4—4 in FIG. 2;
 FIG. 5 is a partial cross-sectional view, on a larger scale, taken along the line 5—5 in FIG. 2;
 FIG. 6 is a partial sectional view, on a larger scale, taken along the line 6—6 in FIG. 2;
 FIG. 7 is a side elevational view of a second embodiment;
 FIG. 8 is a top plan view of the second embodiment;
 FIG. 9 is a bottom plan view of the second embodiment;
 FIG. 10 is a cross-sectional view taken along the line 10—10 in FIG. 8;
 FIG. 11 is a side elevational view of a third embodiment;
 FIG. 12 is a top plan view of the third embodiment;
 FIG. 13 is a bottom plan view of the third embodiment; and
 FIG. 14 is a cross-sectional view taken along the line 14—14 in FIG. 12;
 Enlarged sectional views of the second and third embodiments would be similar to FIGS. 5 and 6 except that there would be the additional concentric raised rings corresponding to the rings shown in FIG. 5 and additional arcuate end portions corresponding to FIG. 6.

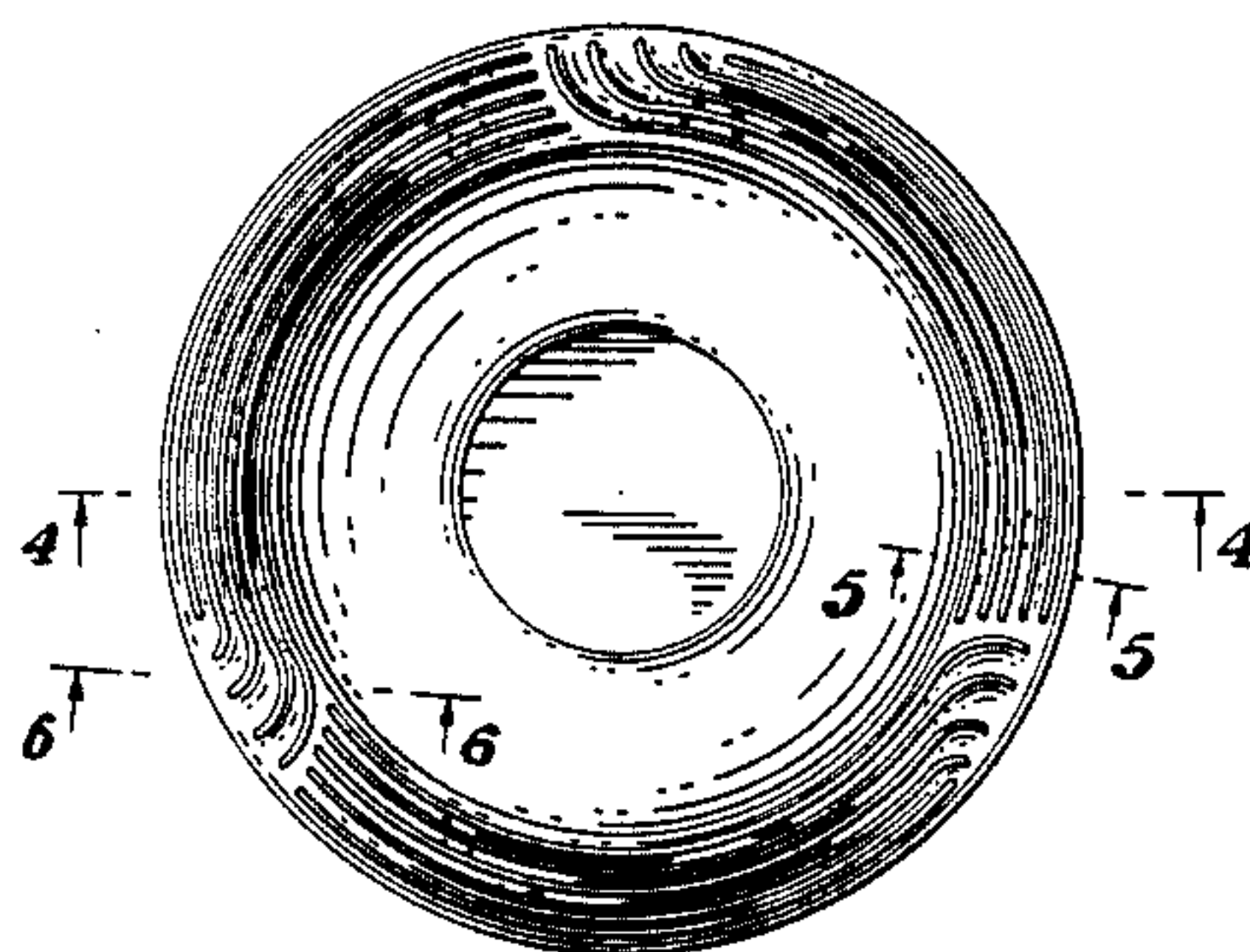

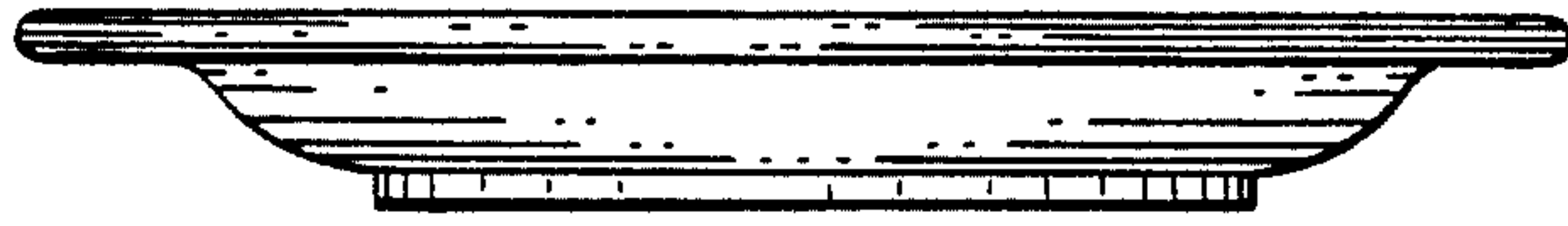

FIG. 1

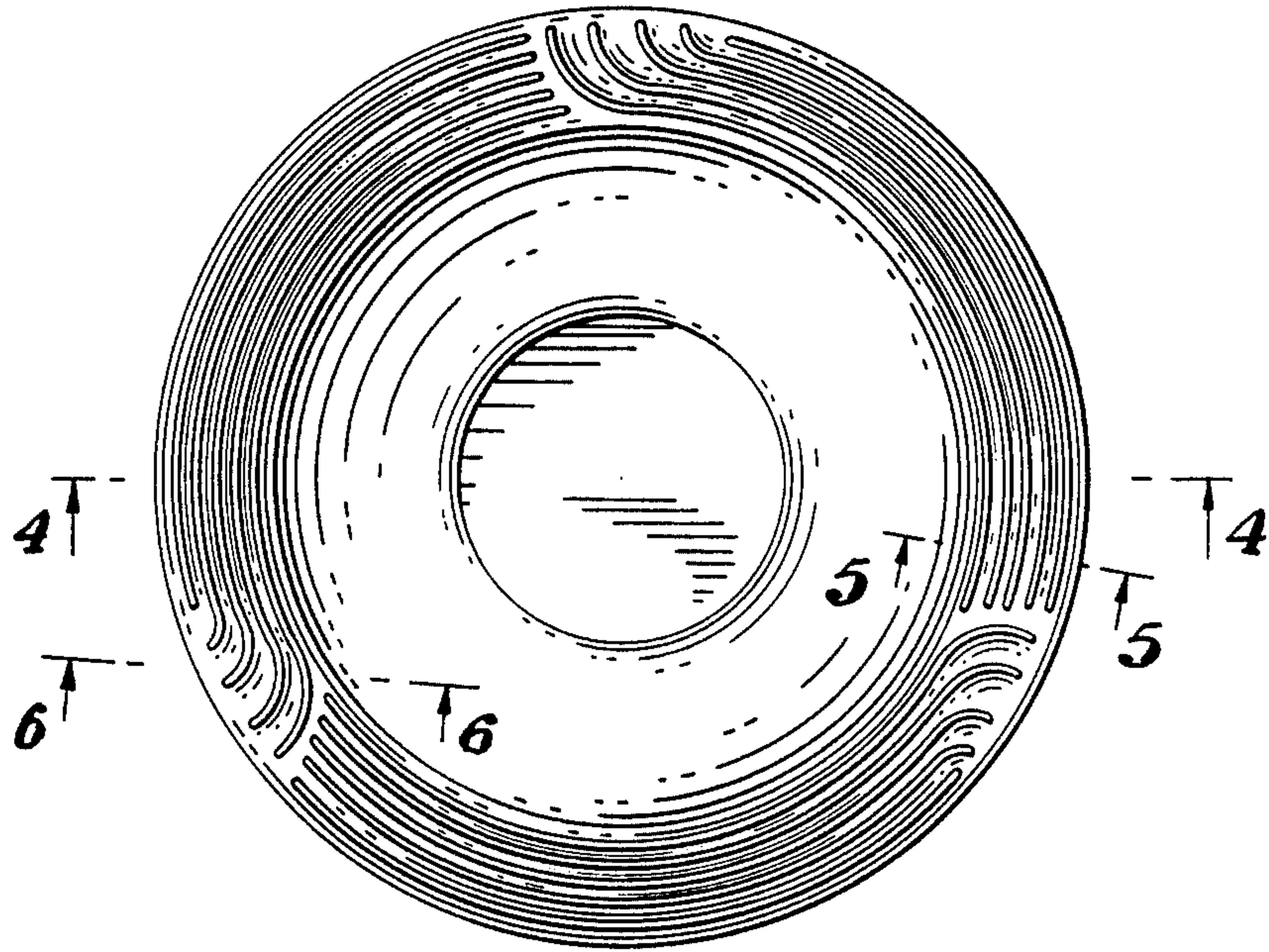

FIG. 2

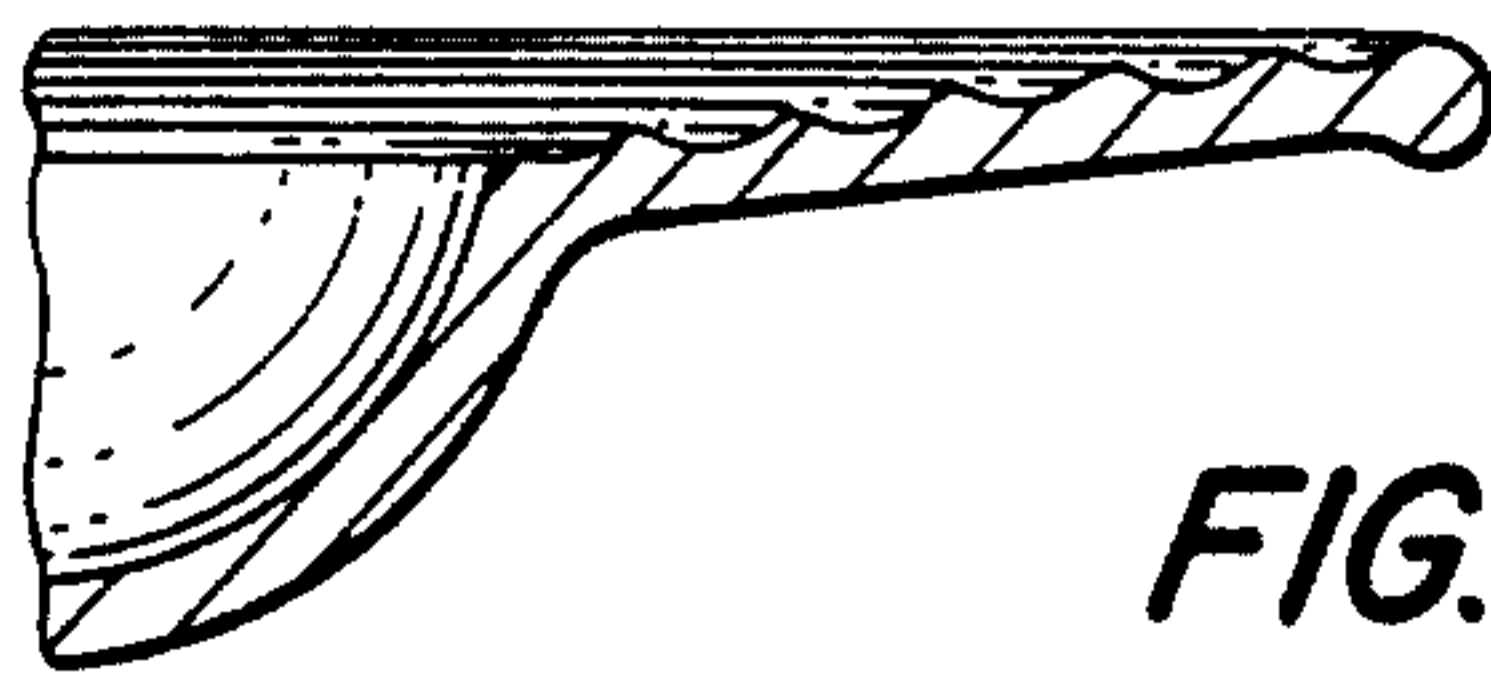

FIG. 5

FIG. 3

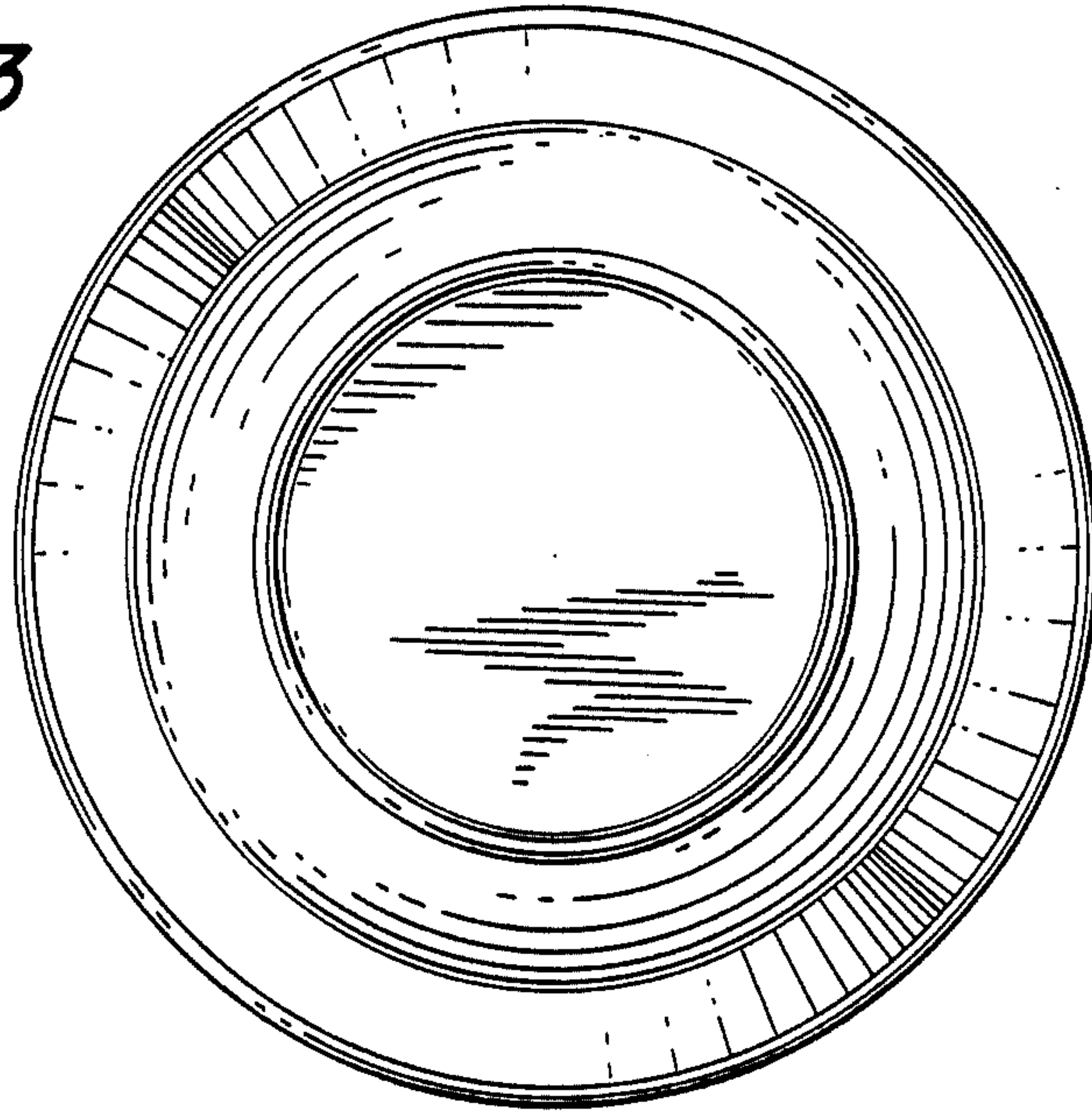

FIG. 4

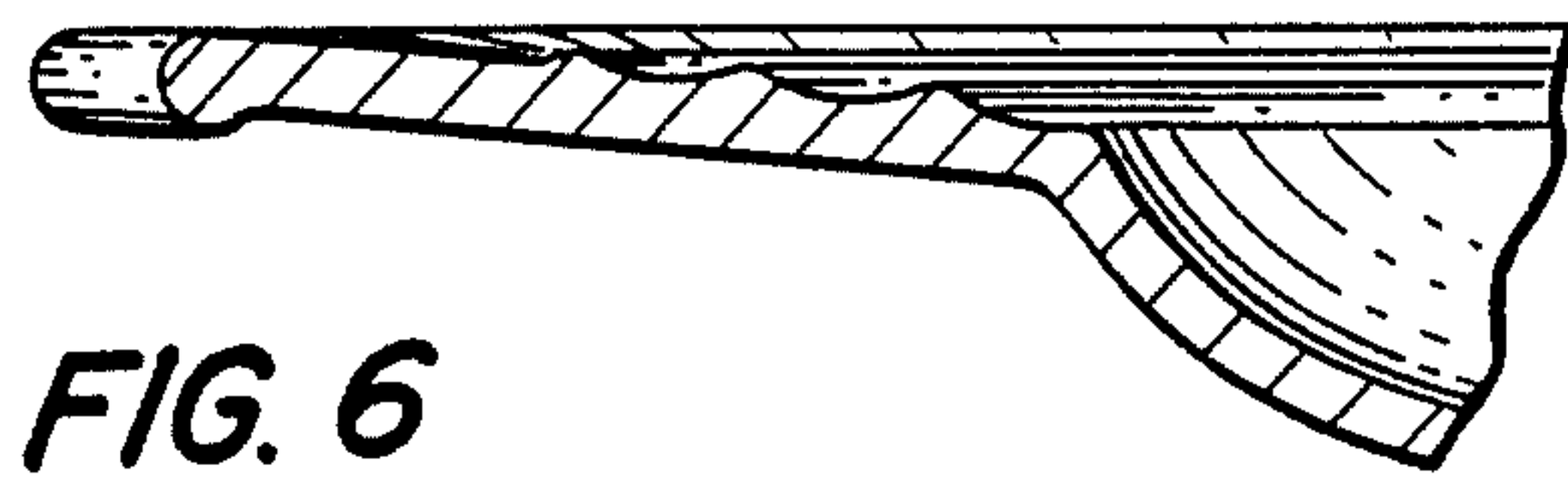
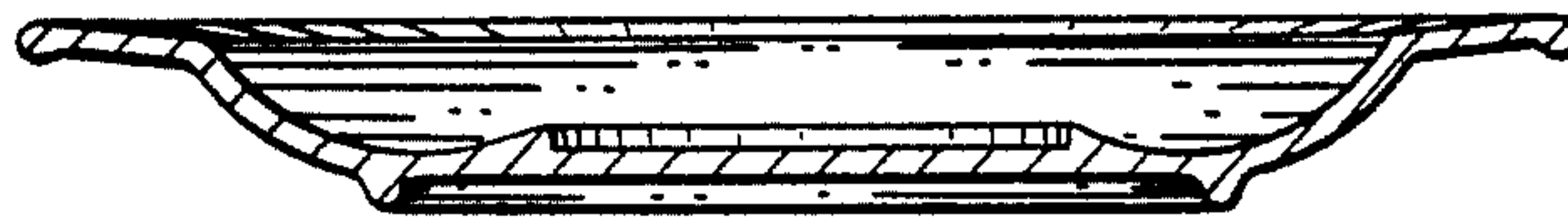

FIG. 6

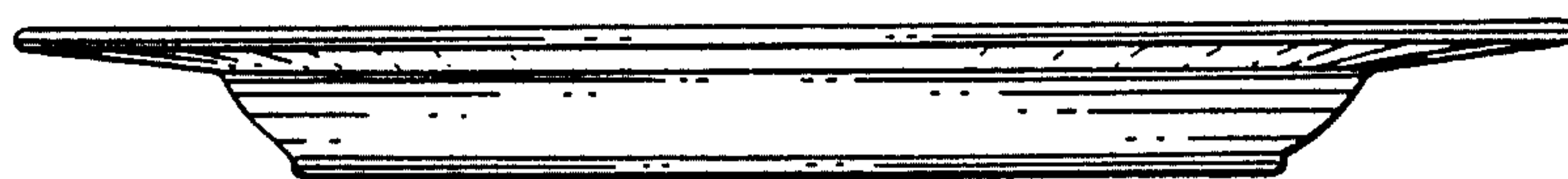

FIG. 7

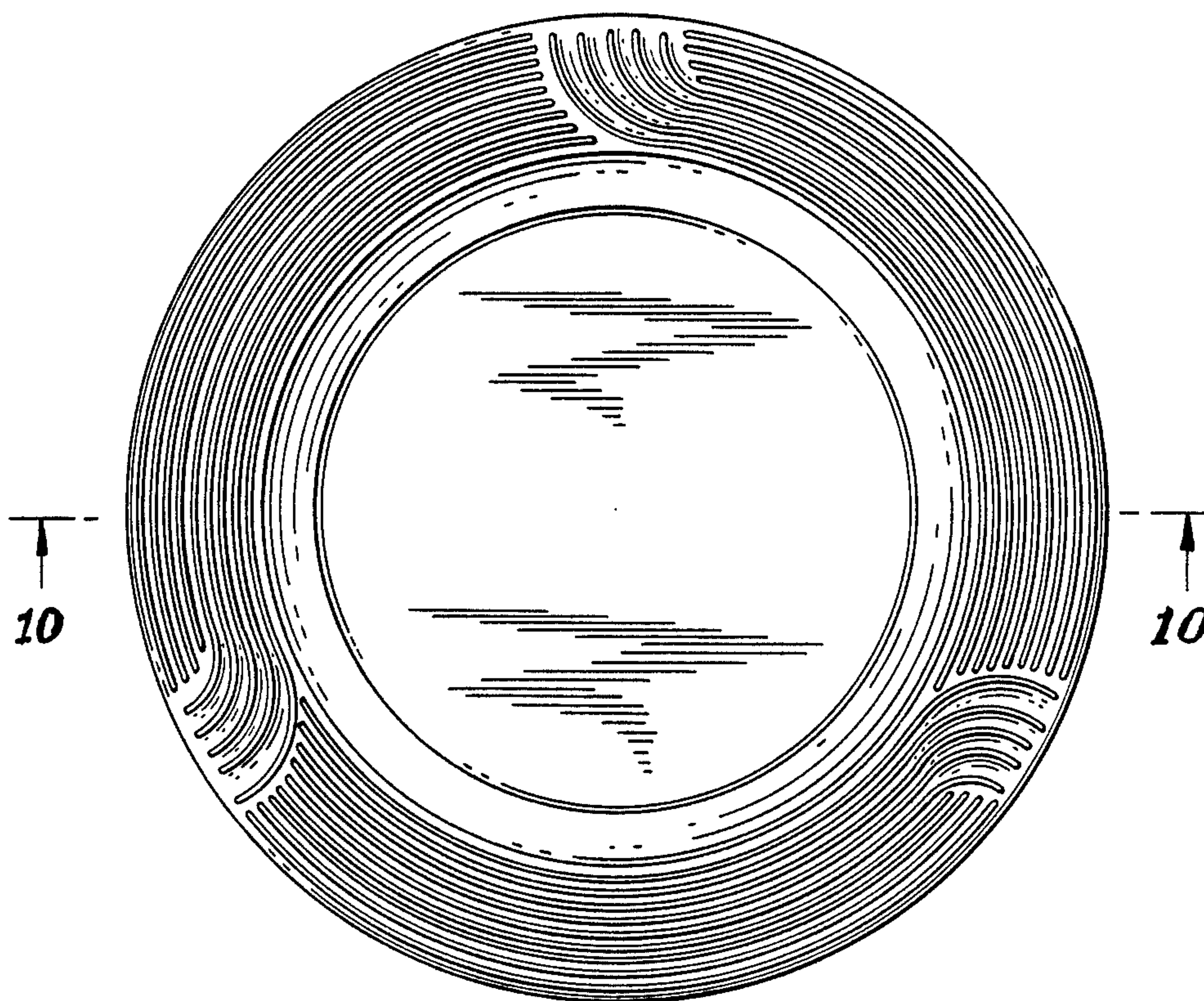

FIG. 8

FIG. 9

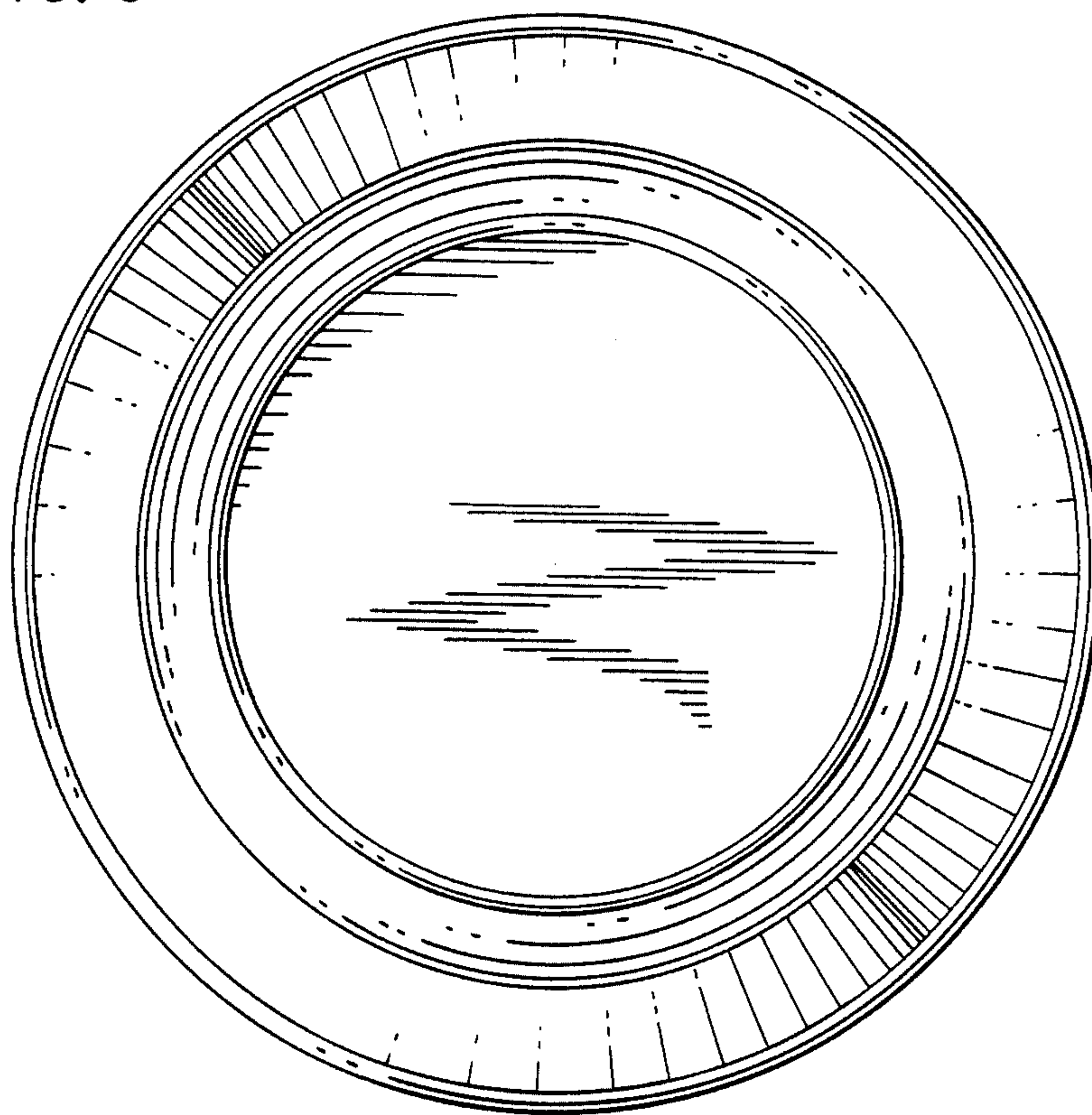

FIG. 10

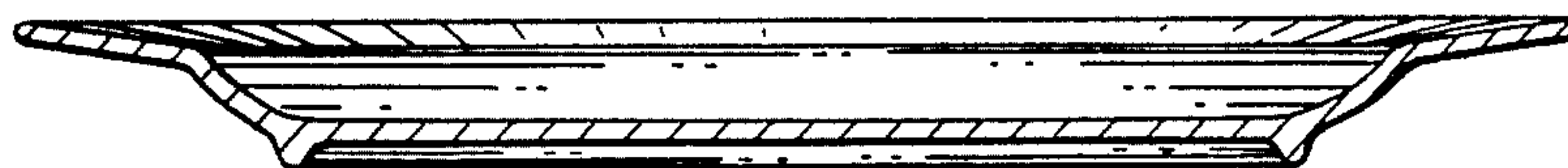

FIG. 11

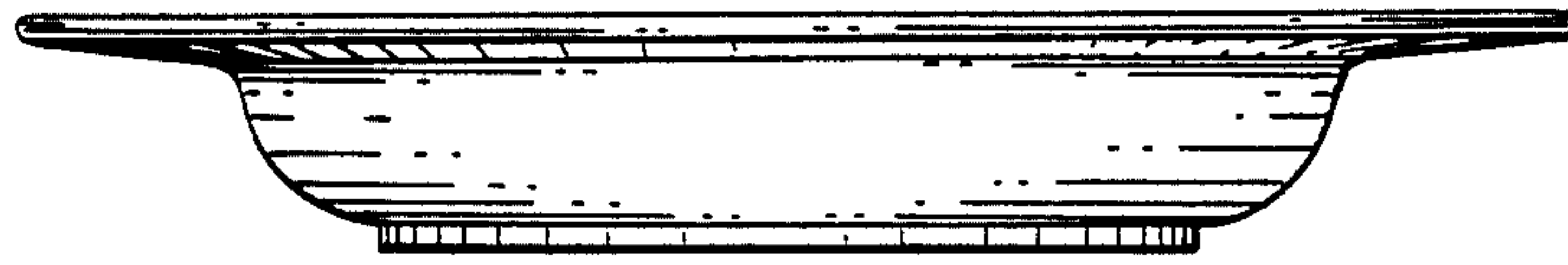

FIG. 12

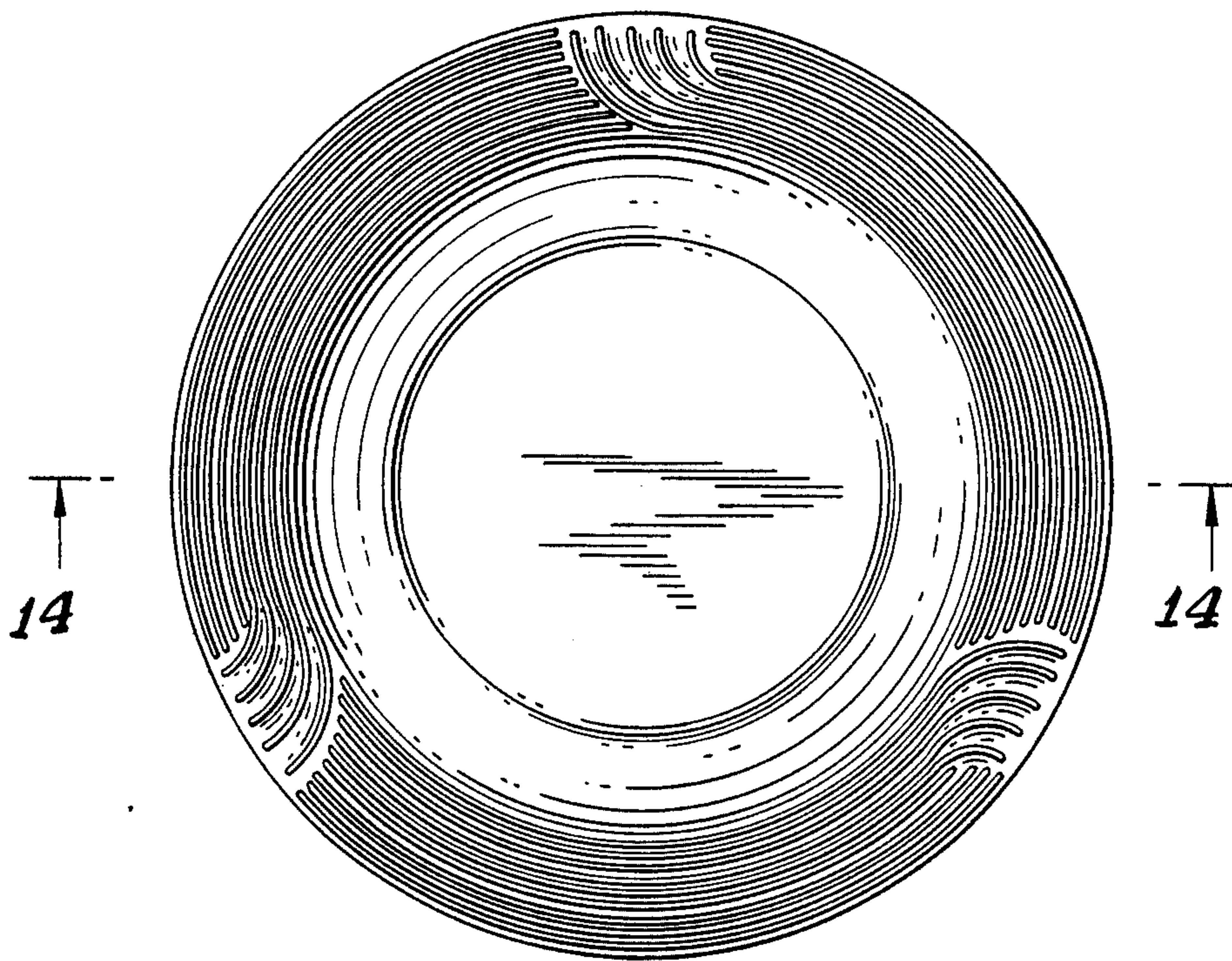

FIG. 13

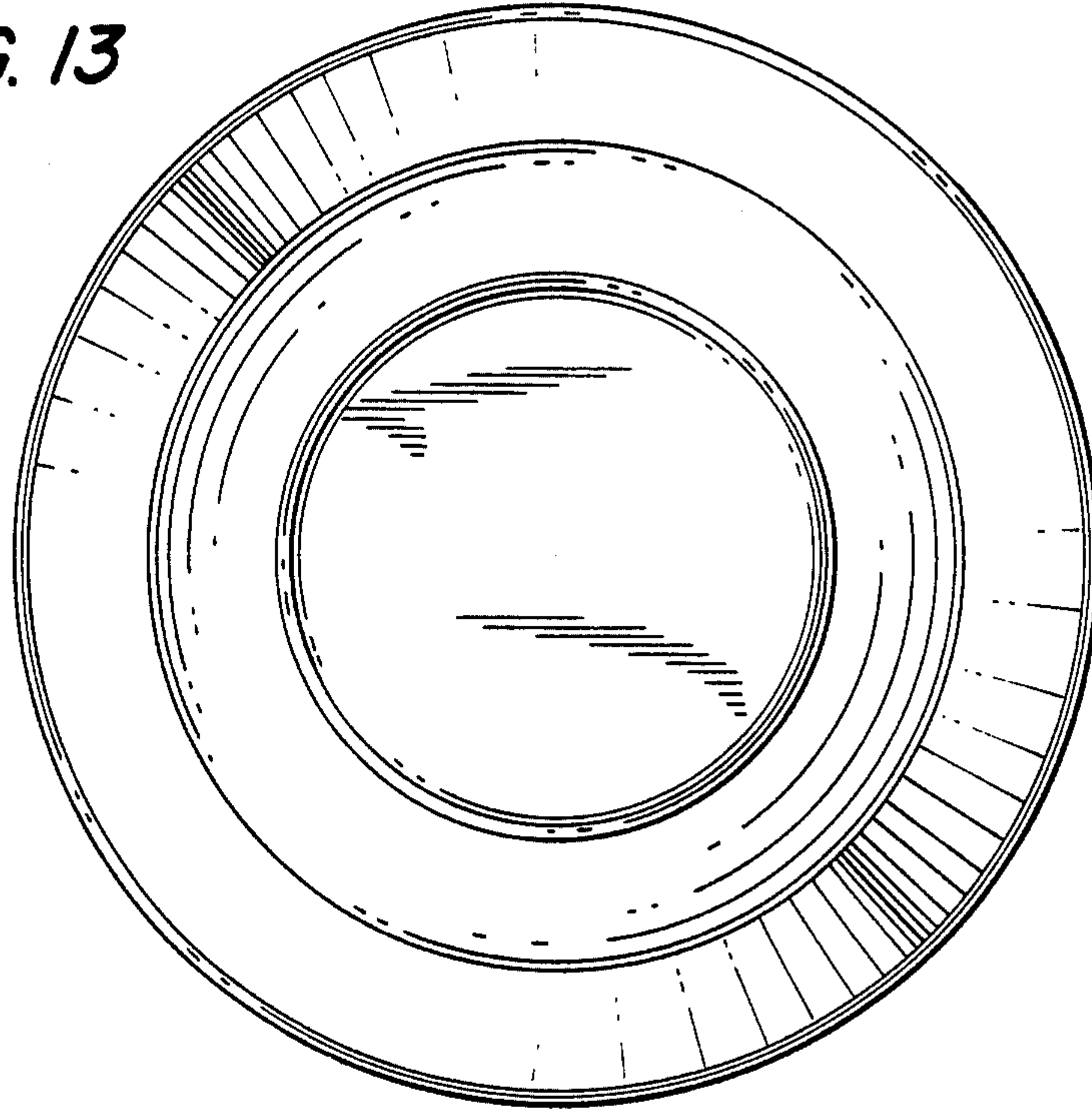

FIG. 14

