

- [54] **COMBINED TRAY, MUGS AND COFFEE SERVICE**
- [75] Inventors: **Jane Ancona; Bruce Ancona**, both of New York, N.Y.
- [73] Assignee: **M. Kamenstein, Inc.**, White Plains, N.Y.
- [**] Term: **14 Years**
- [21] Appl. No.: **376,258**
- [22] Filed: **Jul. 6, 1989**
- [52] U.S. Cl. **D7/507; D7/536; D7/553; D7/300**
- [58] Field of Search **D7/2, 3, 4, 9, 38, 52, D7/58, 81, 300; 206/45; 211/49.1, 53, 74, 77, 78, 79; 220/23.4, 23.83, 23.86**

- D. 280,965 10/1985 Prophet, Jr. et al. D7/2 X
- D. 293,640 1/1988 Perry et al. D7/27
- 927,521 7/1909 Geig 220/23.4 X
- 2,892,540 6/1959 Tupper 206/65
- 4,495,404 1/1985 Carmichael 219/281

FOREIGN PATENT DOCUMENTS

- 874923 5/1942 France 220/23.83

OTHER PUBLICATIONS

Stile Industria #33, p. 21, 8/1961, bottom panel.
Chris Craft Gifts and Gear, p. 44, 4/1976.
Housewares, p. 39, 9/1978.

Primary Examiner—Winifred E. Herrmann
Assistant Examiner—John Warchol
Attorney, Agent, or Firm—Henry R. Lerner

[57] **CLAIM**

The ornamental design for a combined tray, mugs and coffee service, as shown and described.

DESCRIPTION

FIG. 1 is a top, front and right side perspective view of a combined tray, mugs and coffee service showing our new design;
 FIG. 2 is a top plan view;
 FIG. 3 is a front elevational view;
 FIG. 4 is a right side elevational view;
 FIG. 5 is a rear elevational view;
 FIG. 6 is a left side elevational view; and
 FIG. 7 is a bottom plan view.

[56] **References Cited**
U.S. PATENT DOCUMENTS

- D. 93,854 11/1934 Schuelke D7/3
- D. 94,381 1/1935 Felix D7/310
- D. 96,450 8/1935 Daum D7/81
- D. 129,530 9/1941 Manaster D7/71
- D. 162,985 4/1951 Punzak D7/71
- D. 207,963 6/1967 Franklin D7/71
- D. 229,816 1/1974 Wynveen et al. D7/71
- D. 232,295 8/1974 Vujnovic D7/58
- D. 240,578 7/1976 Gottsegen D6/144
- D. 242,685 12/1976 Skidell D7/71
- D. 256,204 8/1980 Adiv-Maccise D7/3
- D. 265,154 6/1982 Cox D6/138

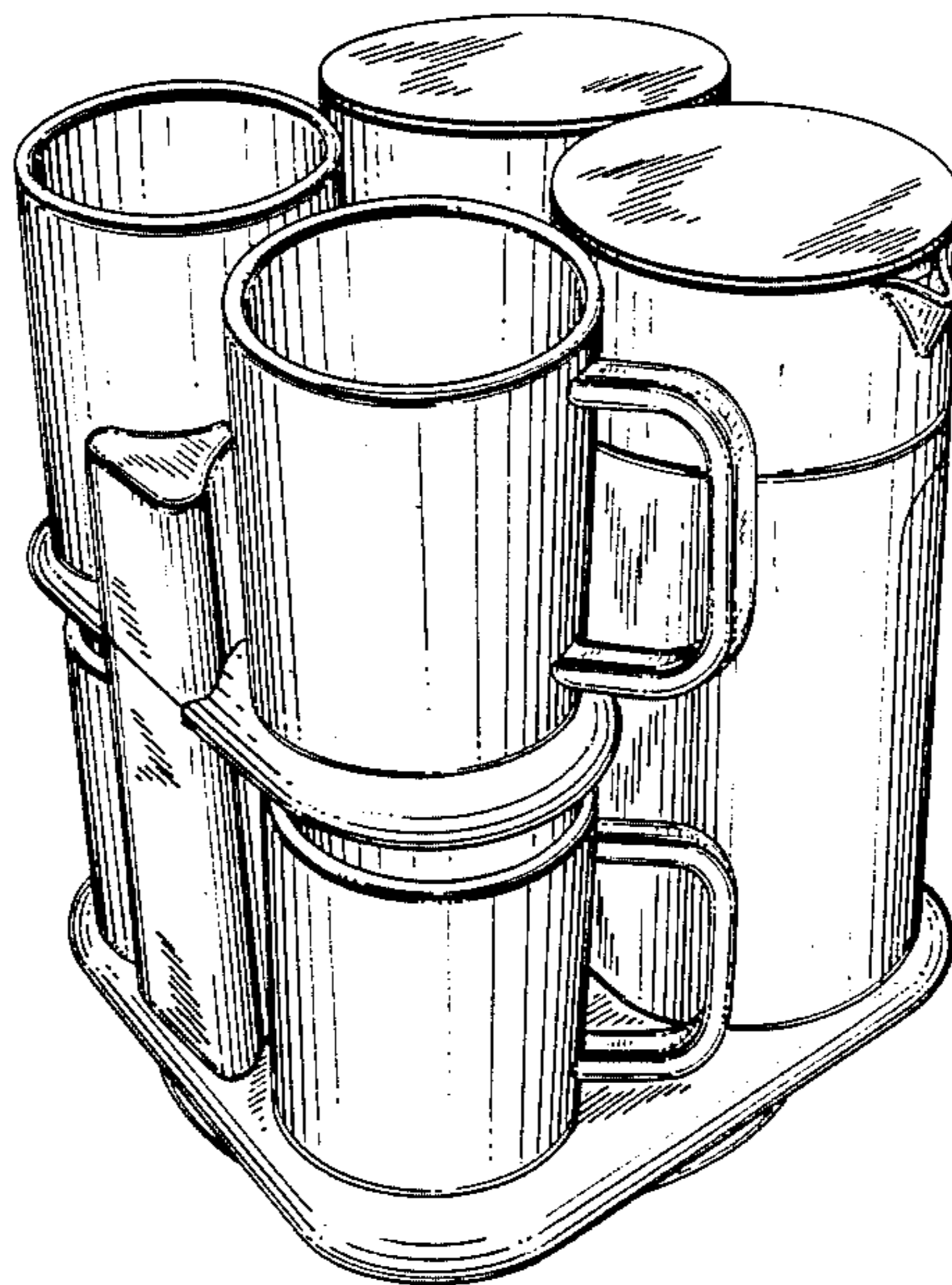

FIG. 1

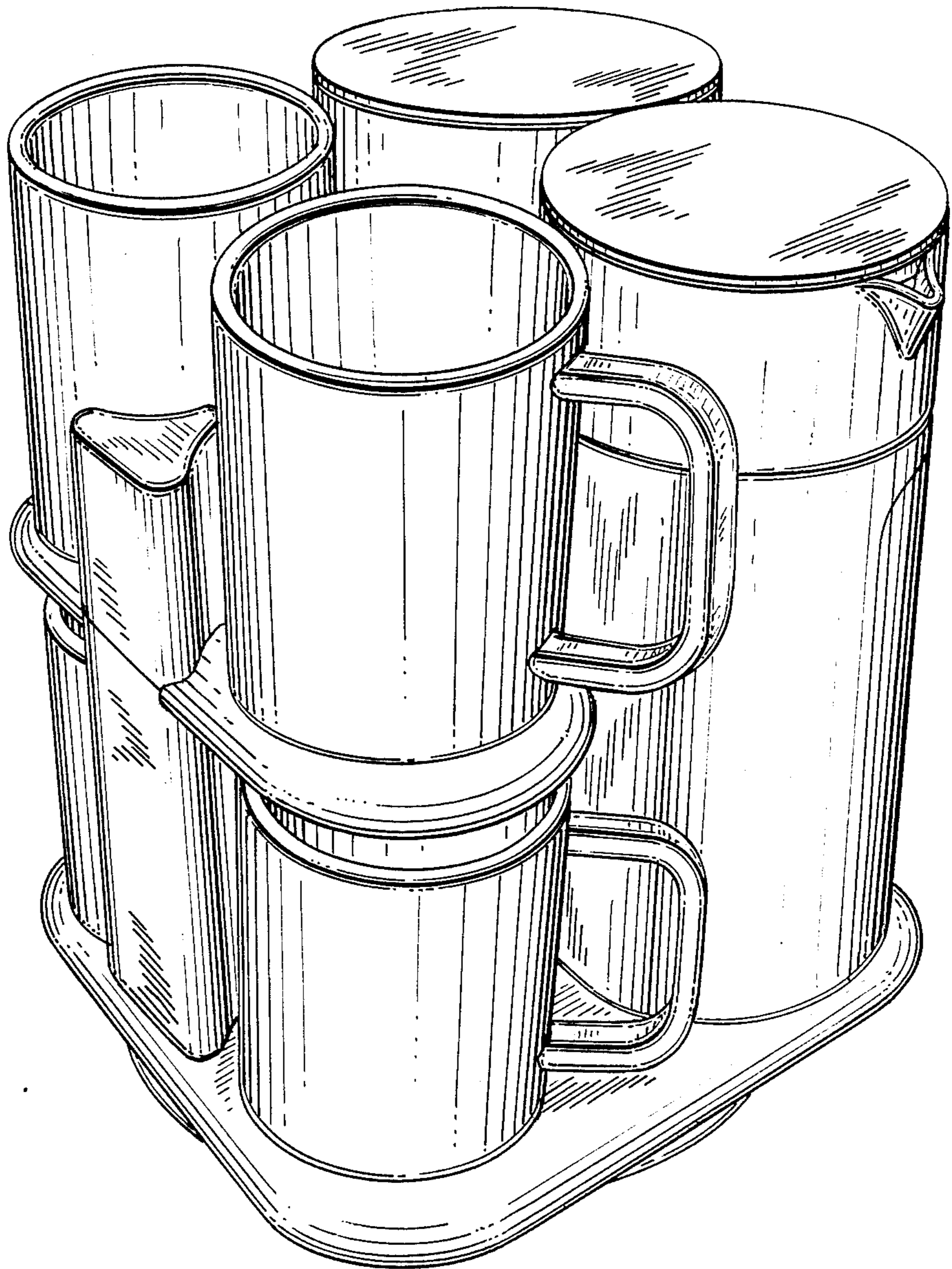

FIG. 3

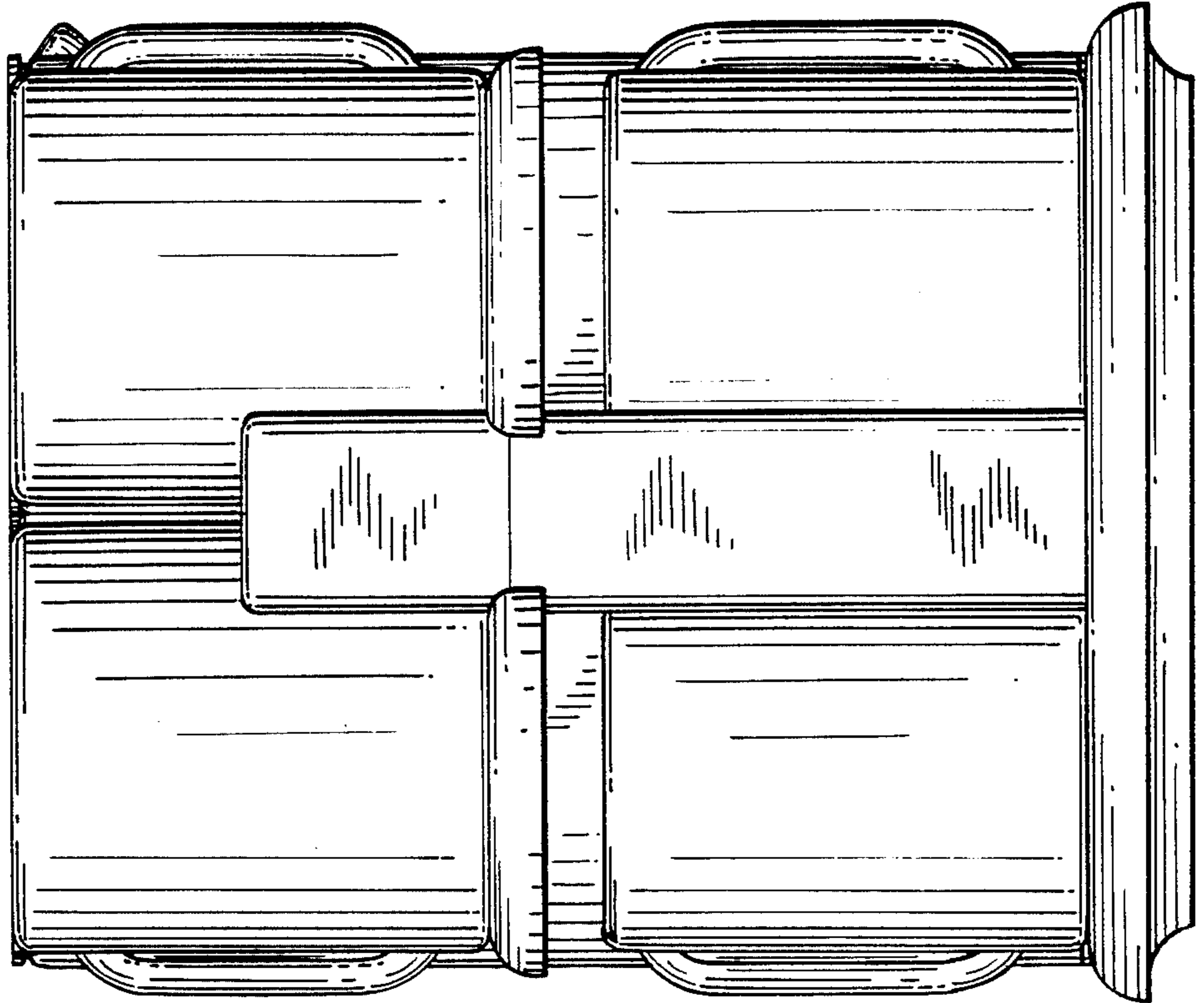

FIG. 2

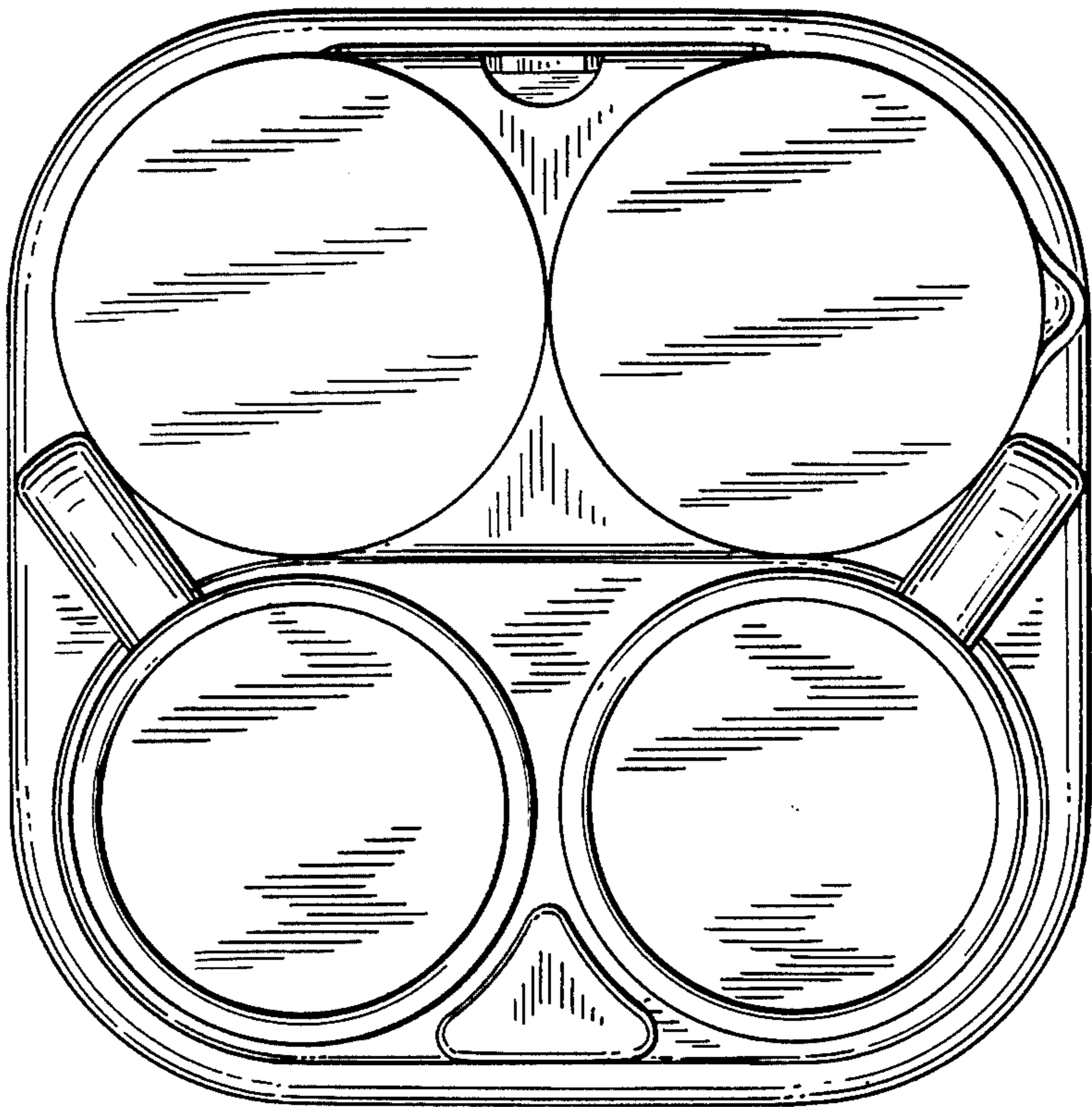

FIG. 5

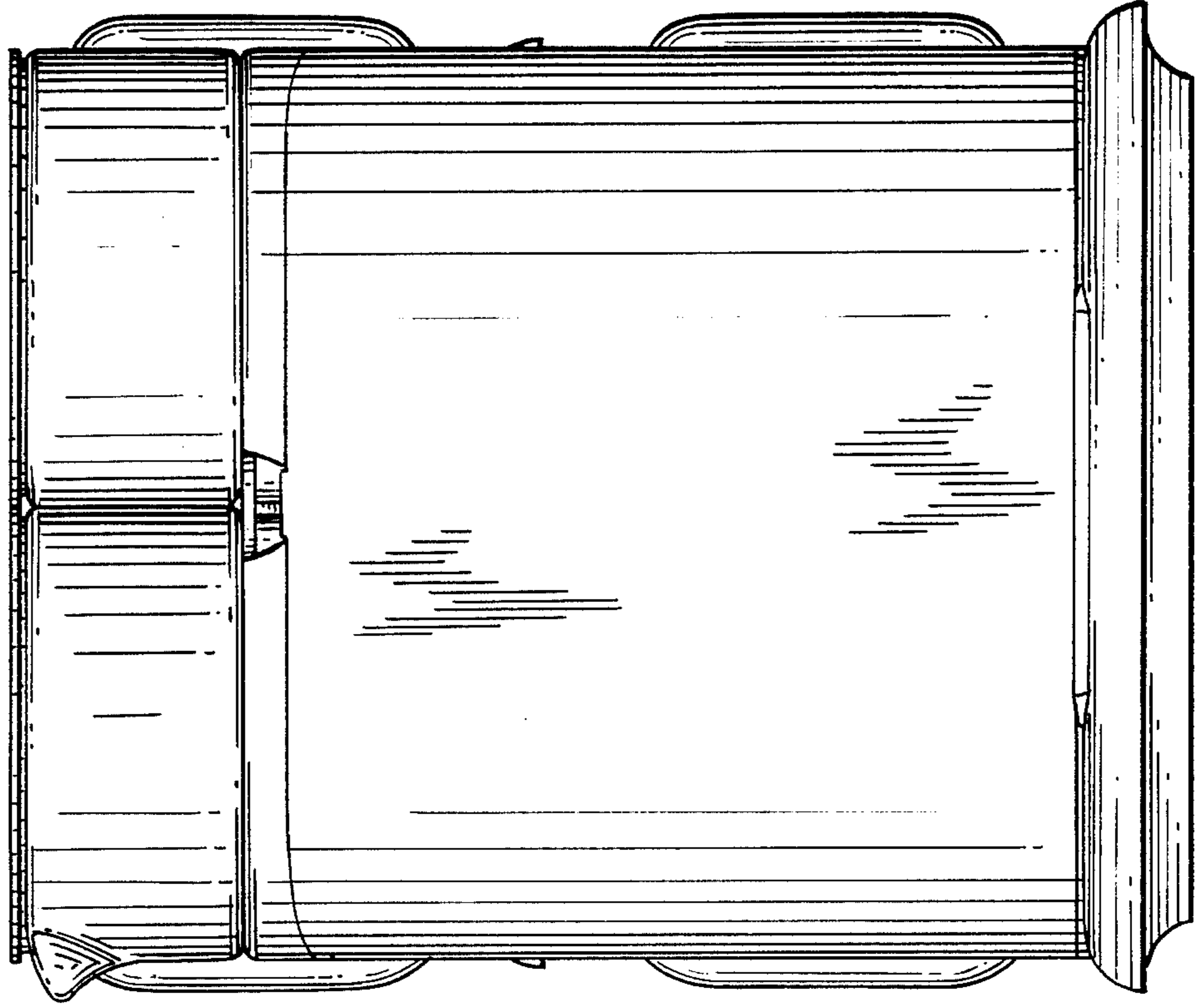

FIG. 4

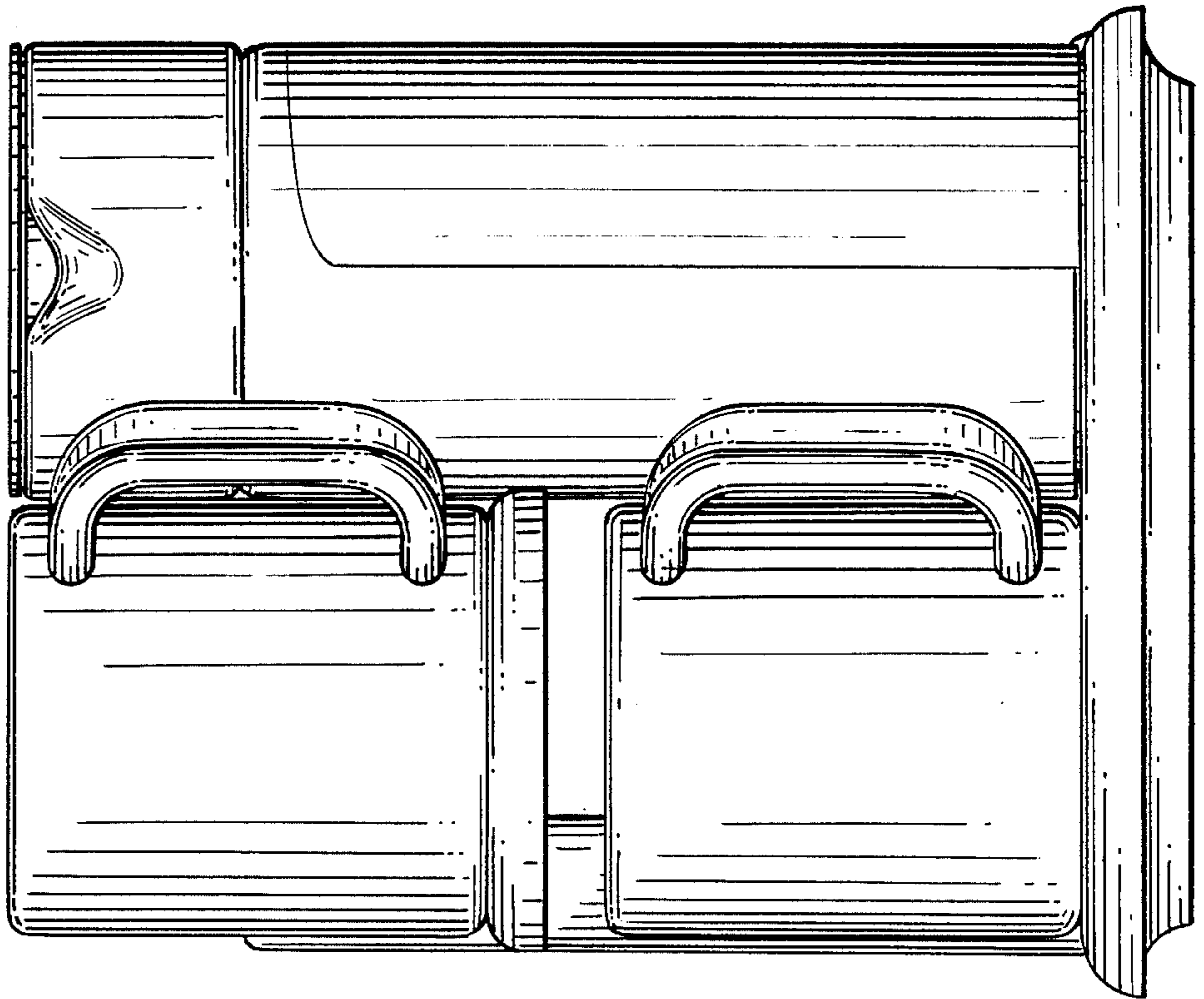

FIG. 7

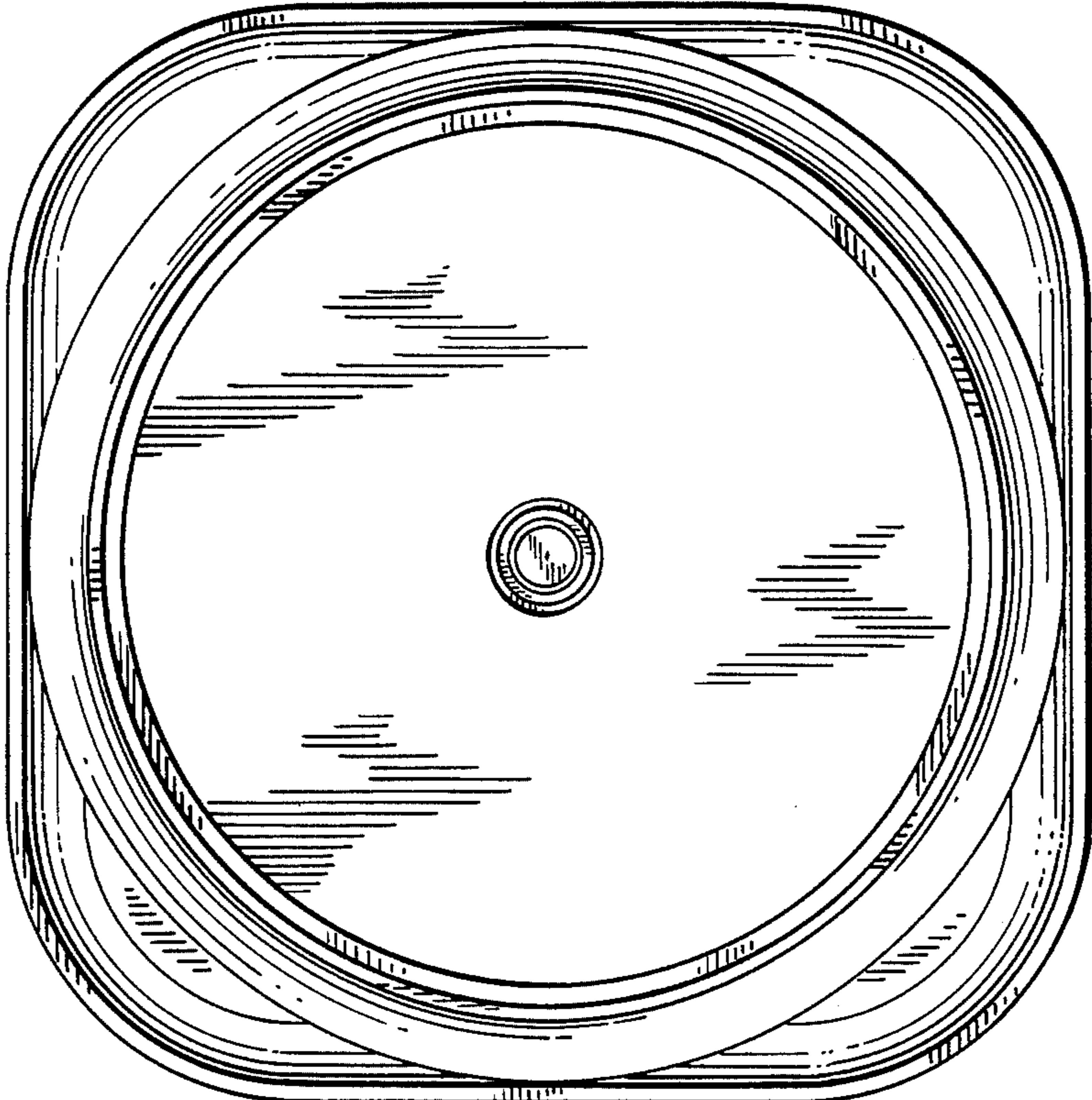

FIG. 6

