

[54] **PORTABLE WATER FILTER**

[76] **Inventor: James L. Lieberman, 1720 S. Marshall Rd., #25, Boulder, Colo. 80302**

[**] **Term: 14 Years**

[21] **Appl. No.: 266,991**

[22] **Filed: Nov. 4, 1988**

[52] **U.S. Cl. D23/209**

[58] **Field of Search D23/200, 207, 208, 209, D23/210; 210/136, 234, 238, 282, 440, 444, 447, 448, 446, 492, 457, 449, 232, 256, 258, 302, 416.3**

[56] **References Cited**

U.S. PATENT DOCUMENTS

2,436,077 2/1948 Robertson 210/416.3 X

2,566,371 9/1951 Quinn 210/416.3 X
4,477,347 10/1984 Sylva 210/232

Primary Examiner—Wallace R. Burke
Assistant Examiner—M. H. Tung
Attorney, Agent, or Firm—Donald W. Margolis

[57] **CLAIM**

The ornamental design for a portable water filter, as shown and described.

DESCRIPTION

FIG. 1 is a bottom front perspective view of the portable water filter showing my new design; FIG. 2 is a front elevational view thereof; FIG. 3 is a right elevational view thereof; FIG. 4 is a rear elevational view thereof; FIG. 5 is a left elevational view thereof; FIG. 6 is a top plan view thereof; and FIG. 7 is a bottom plan view thereof.

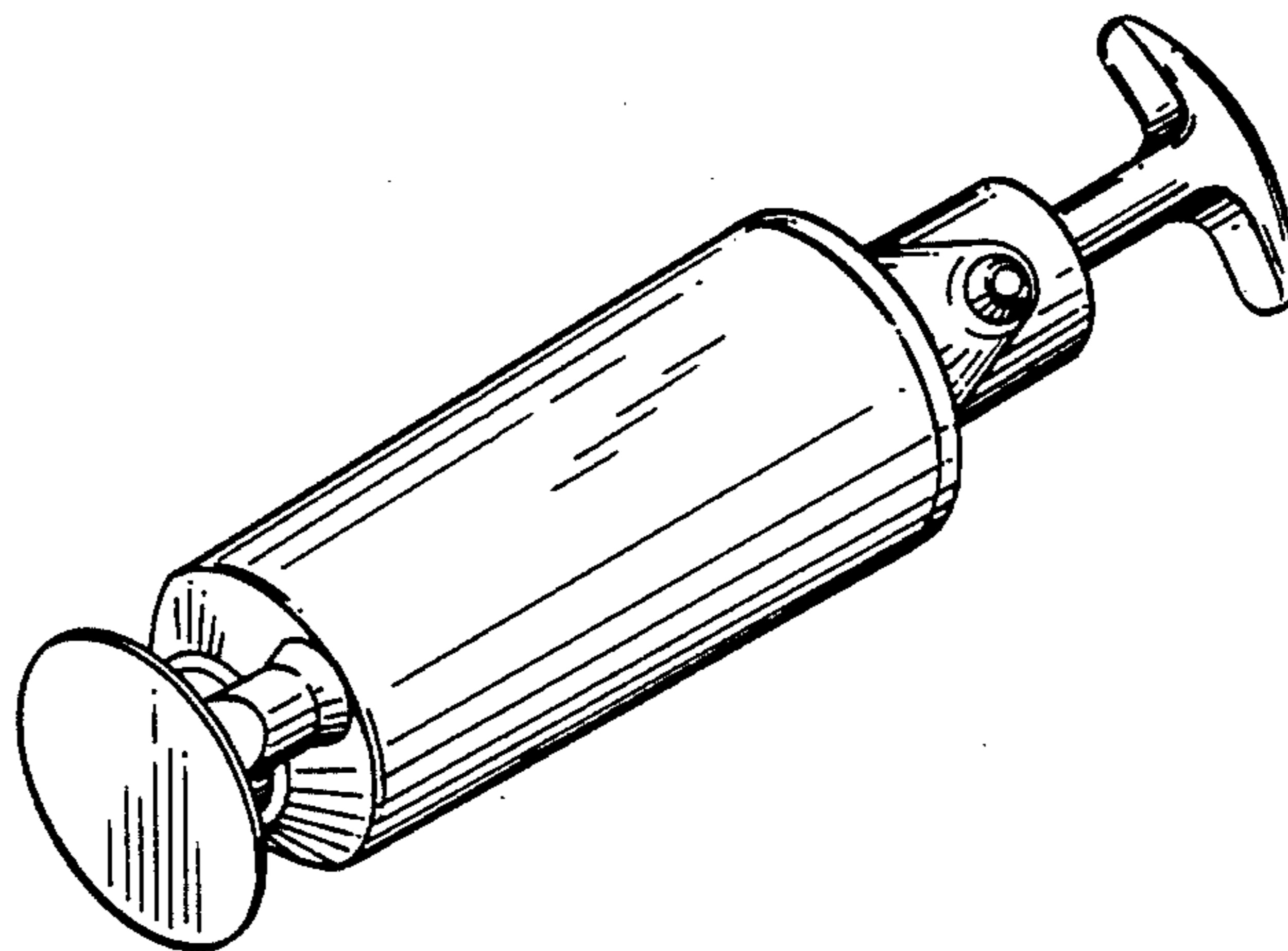

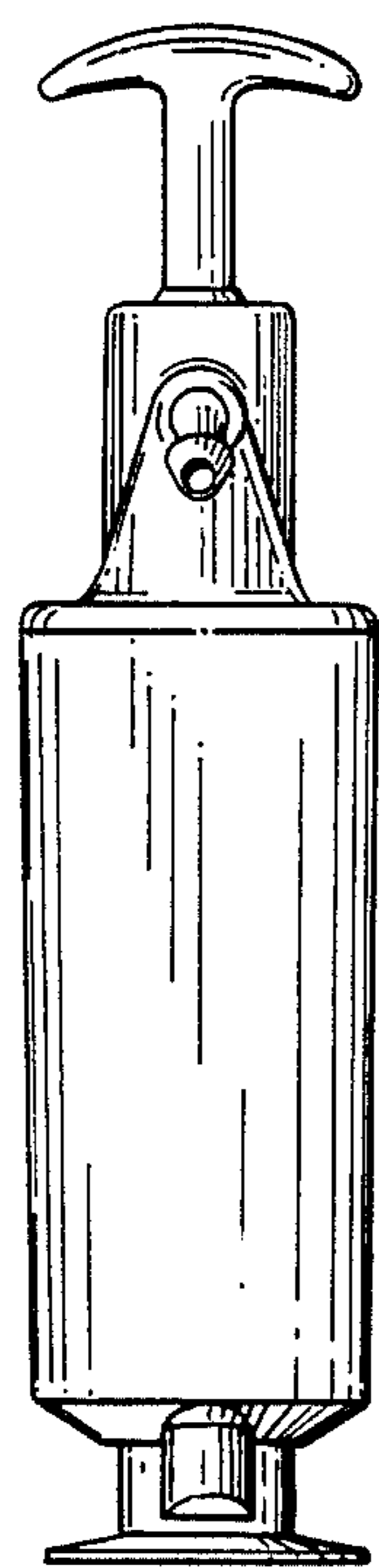

FIG. 2.

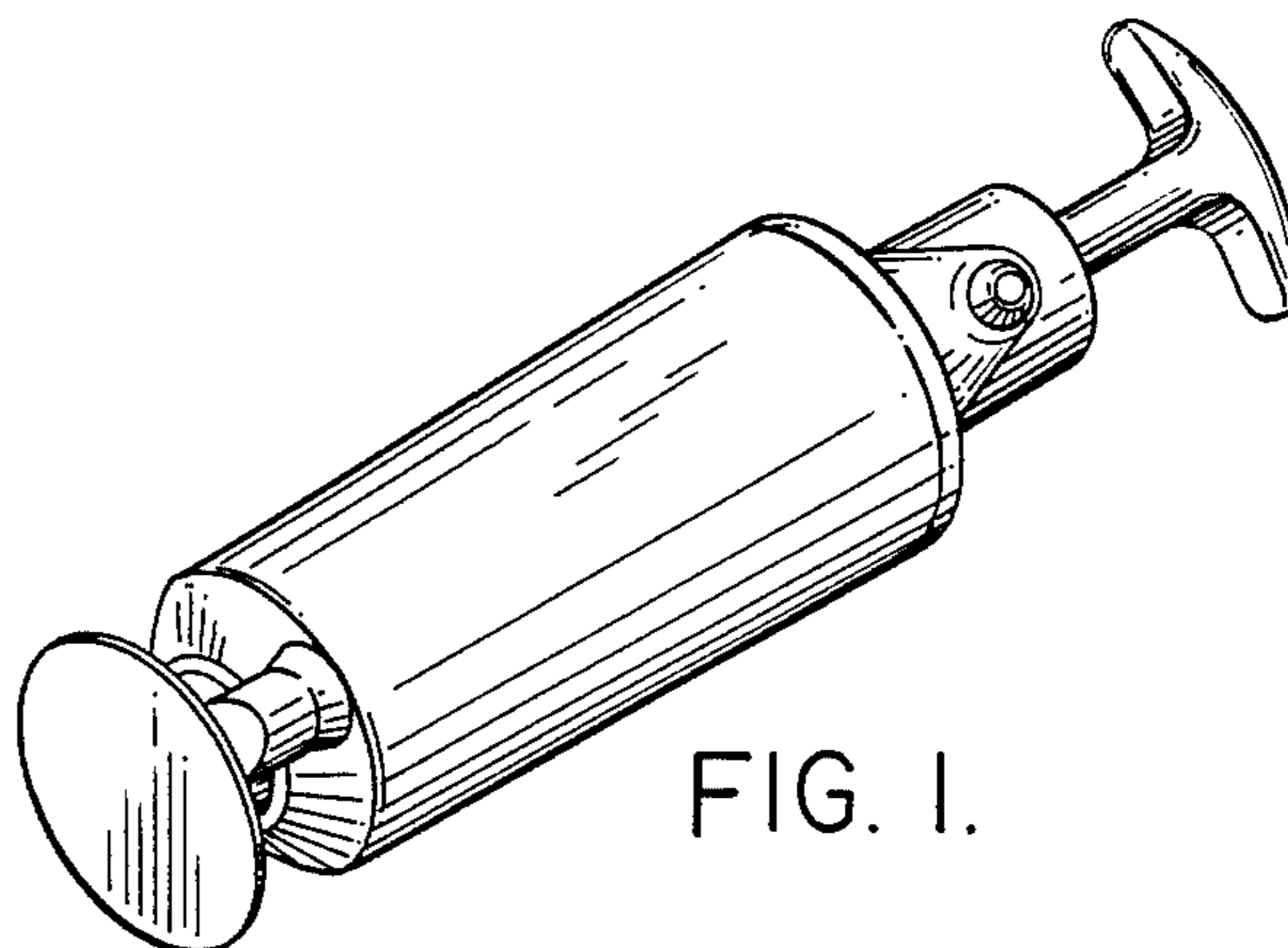

FIG. 1.

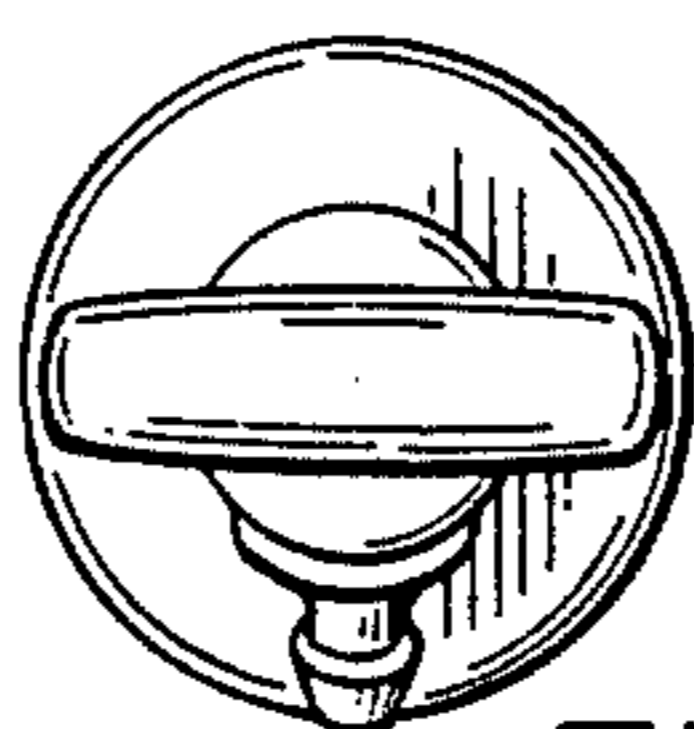

FIG. 6.

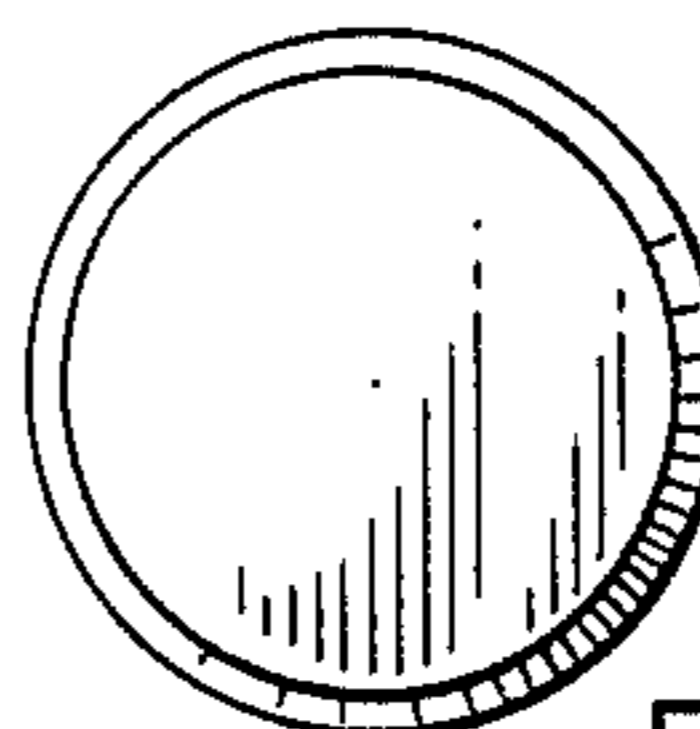

FIG. 7.

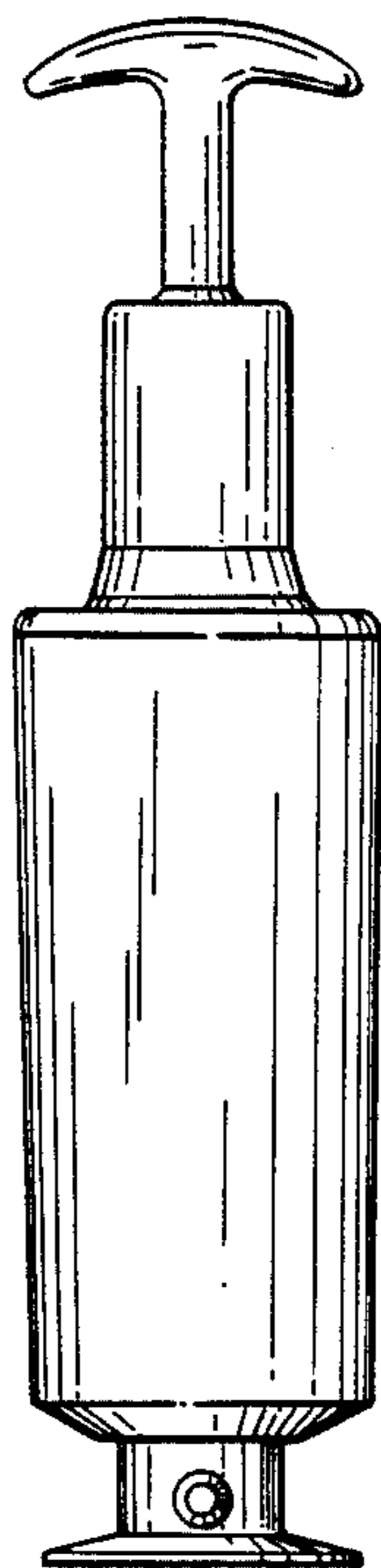

FIG. 4.

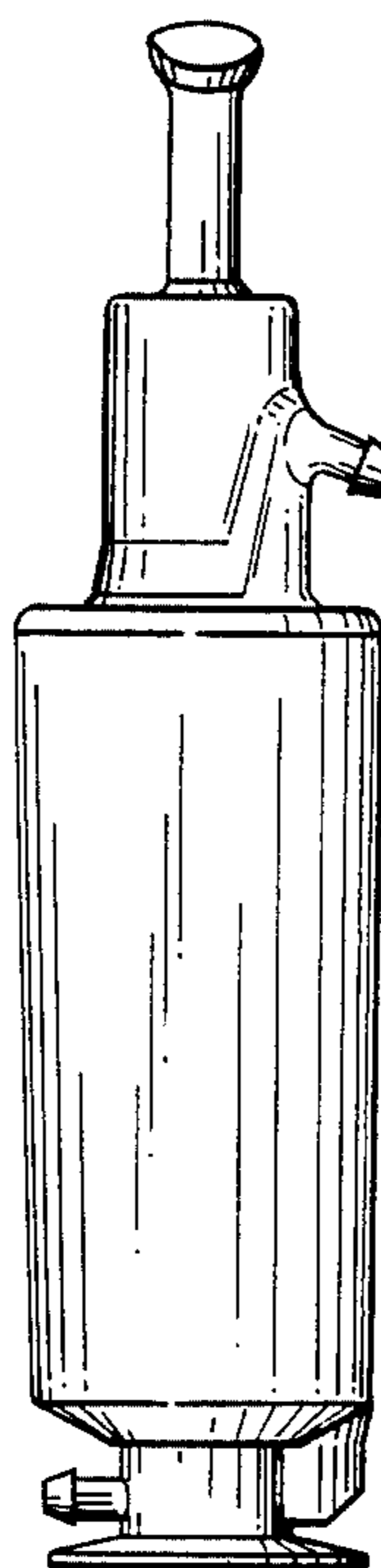

FIG. 5.

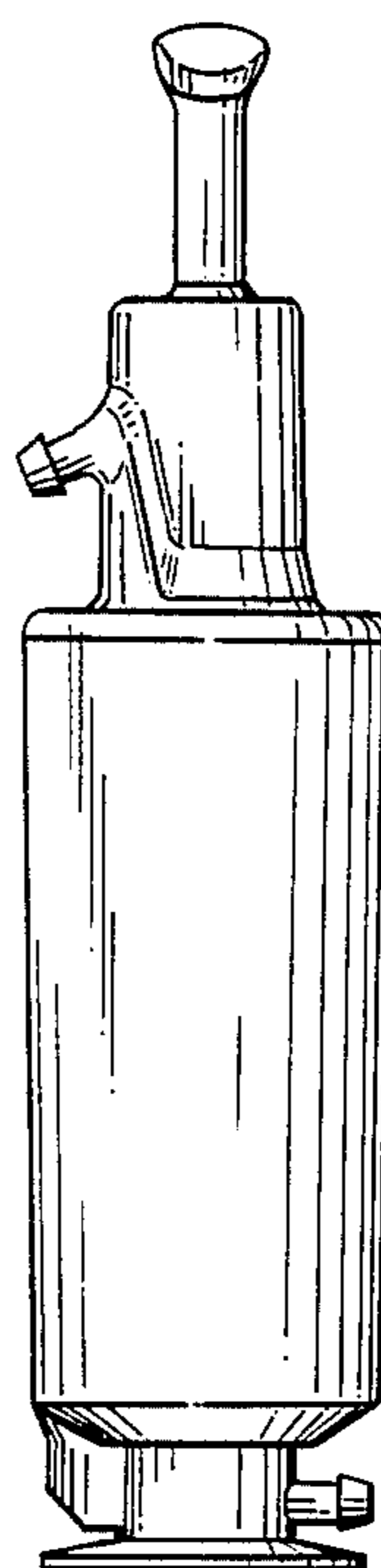

FIG. 3.