

[54] **COMBINED TAPE RECORDER AND RADIO**

[75] **Inventor:** Mitsutaka Fuke, Osaka, Japan
[73] **Assignee:** Sharp Corporation, Osaka, Japan
[**] **Term:** 14 Years
[21] **Appl. No.:** 171,531
[22] **Filed:** Mar. 22, 1988

[30] **Foreign Application Priority Data**

Sep. 28, 1987 [JP] Japan 62-39871
[52] **U.S. Cl.** D14/163; D14/168
[58] **Field of Search** D14/141, 160-168,
D14/188-189, 191-192, 196, 199, 202, 299;
455/344, 350, 351

[56] **References Cited**

U.S. PATENT DOCUMENTS

D. 294,567 3/1988 Fujii D14/163
D. 296,690 7/1988 Koo D14/168 X
D. 297,833 9/1988 Kawabe et al. D14/163
D. 297,834 9/1988 Kawabe et al. D14/163

OTHER PUBLICATIONS

HFD; 06/01/87; p. 118; topright-Lloyd Model V501 Boombox CD Player.
HFD; 01/05/87; p. 116 (insert); Sanyo Model MS450.
HFD; 06/01/87; p. 116; topright-Gran Prix Dual-Cassette Portable Stereo.

Primary Examiner—Theodore M. Shooman
Attorney, Agent, or Firm—Flehr, Hohbach, Test, Albritton & Herbert

[57] **CLAIM**

The ornamental design for a combined tape recorder and radio, as shown and described.

DESCRIPTION

FIG. 1 is a top, front and right side perspective view of a combined tape recorder and radio showing our new design, with the antenna and handle extended and the tape holder in an open position;
FIG. 2 is a front elevational view thereof;
FIG. 3 is a rear elevational view thereof;
FIG. 4 is a top plan view thereof;
FIG. 5 is a bottom plan view thereof;
FIG. 6 is a right side elevational view thereof; and
FIG. 7 is a left side elevational view thereof.

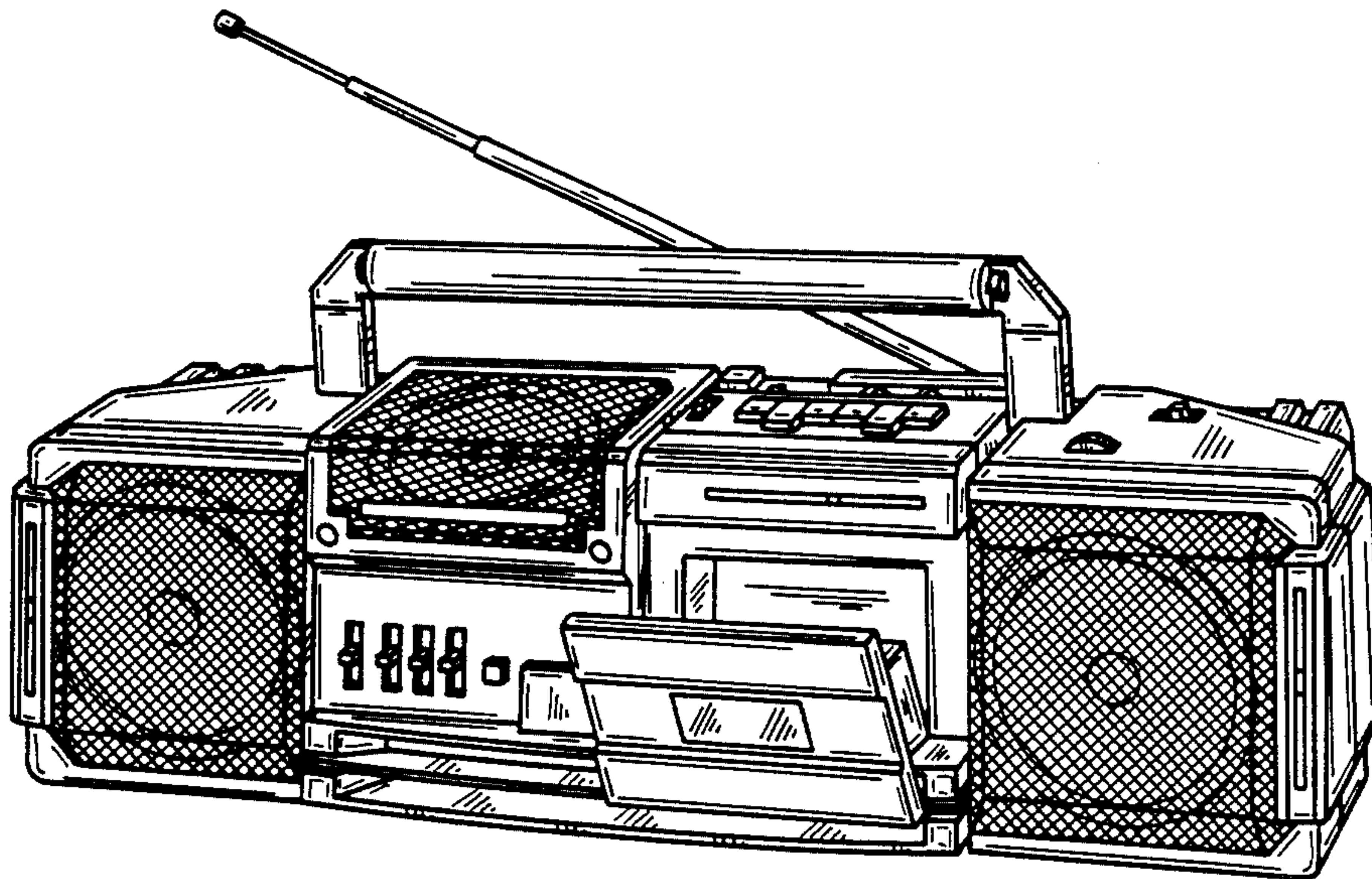

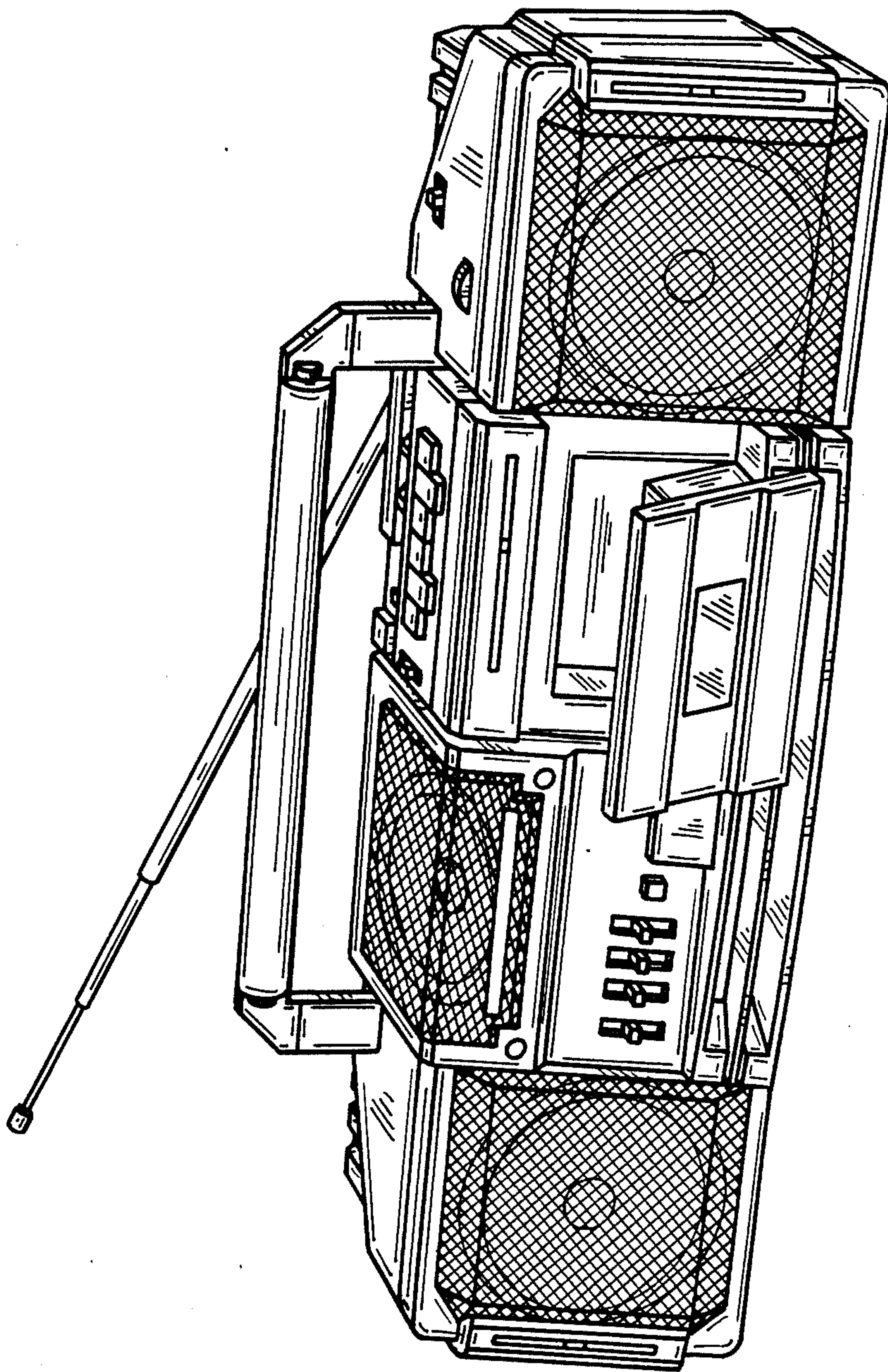
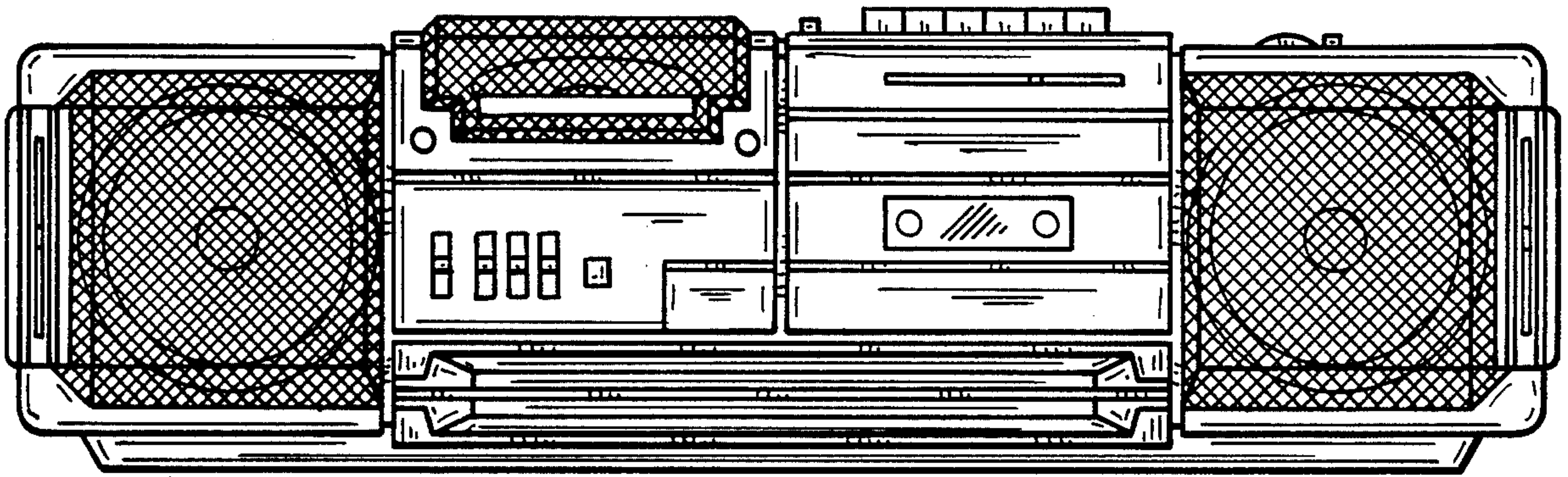
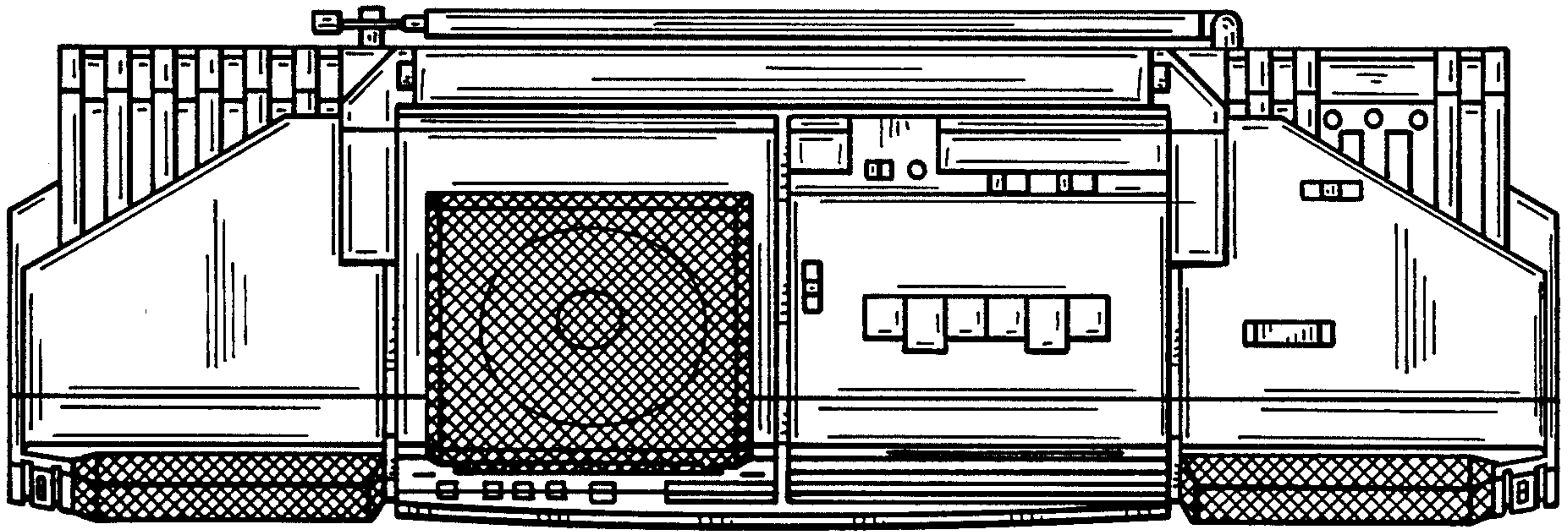

FIG. 1



FIG_2



FIG_4

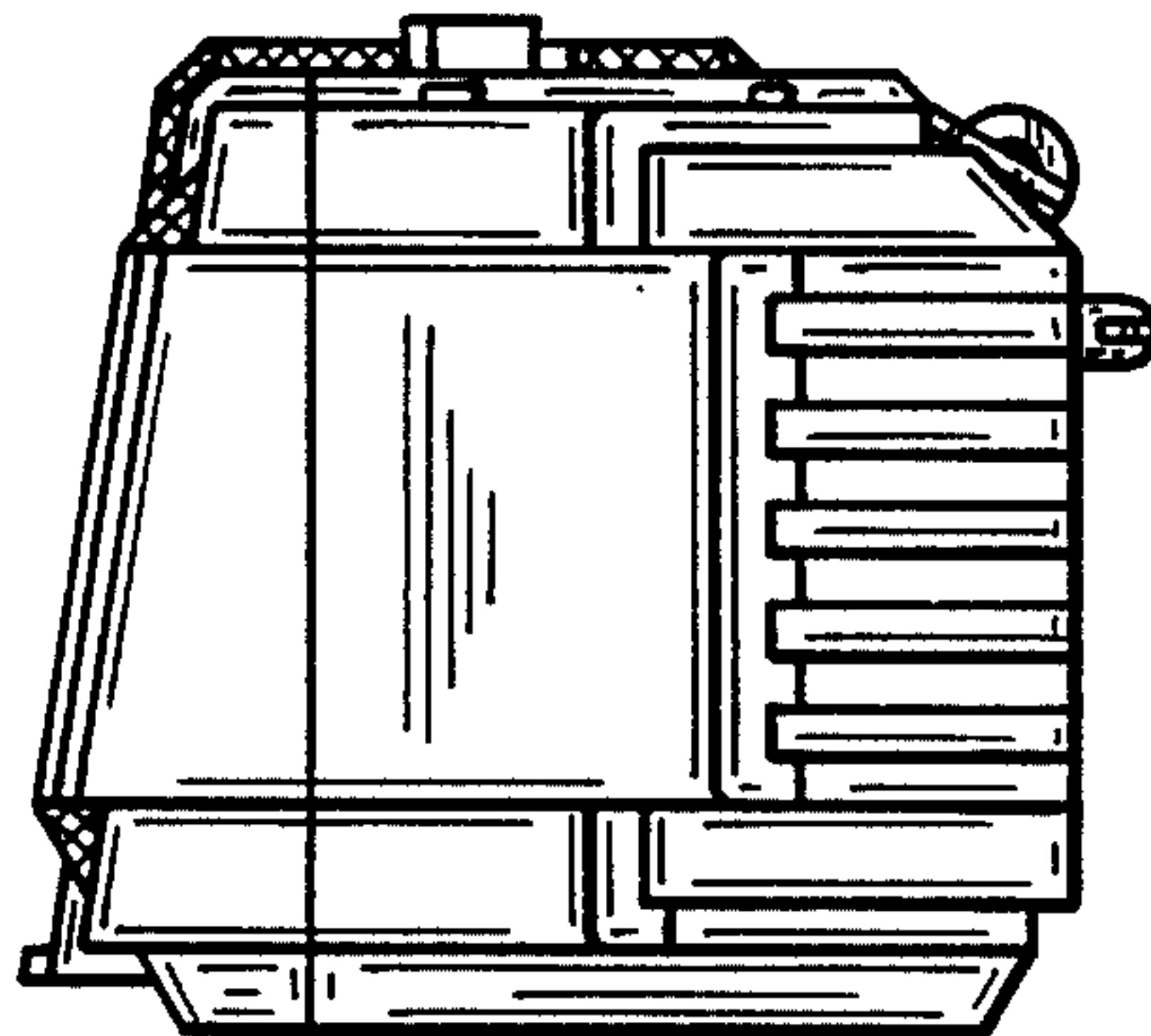

FIG_6

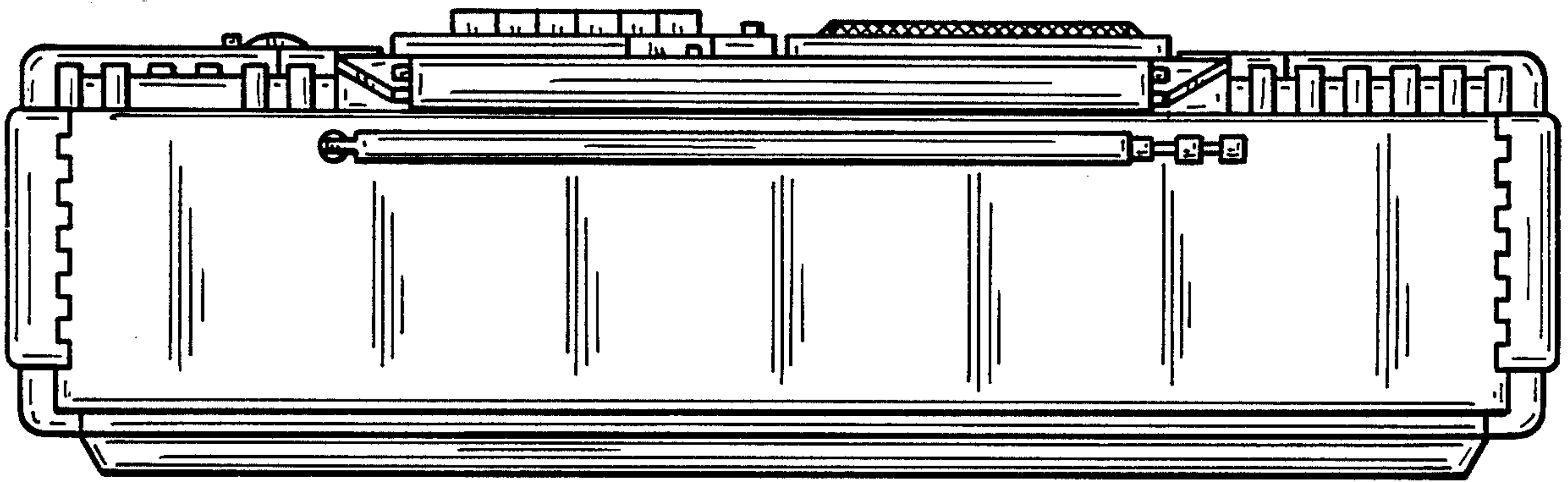

FIG_3

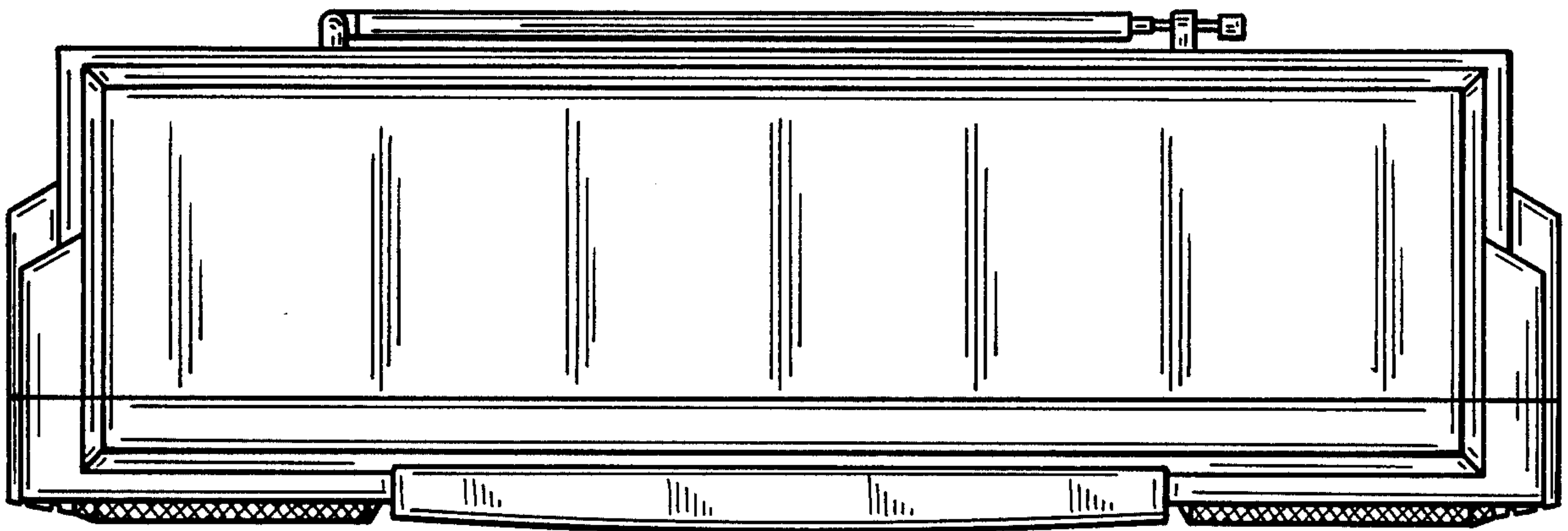

FIG_5

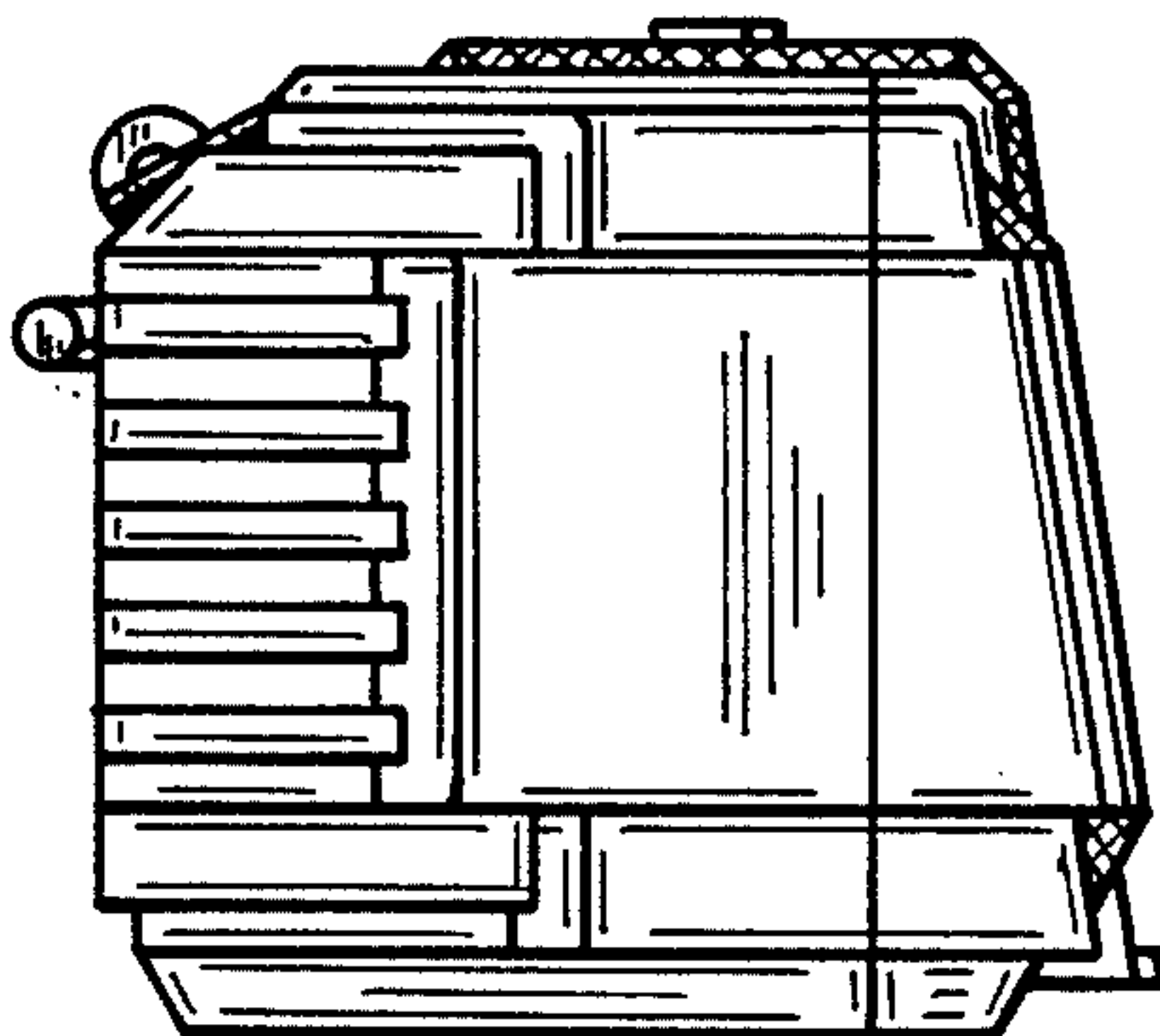

FIG_7