

[54] WICKER CONTAINER

[76] Inventor: Barbara A. Grimm, Block 26, 25 Floor, Flat C, 555 Victoria Road, Baguio Villa, Hong Kong

[**] Term: 14 Years

[21] Appl. No.: 211,688

[22] Filed: Jun. 27, 1988

[52] U.S. Cl. D9/414

[58] Field of Search D9/414; D34/40, 41, D34/42; 217/122-125, 40, 68; 144/333; 147/48

[56] References Cited

U.S. PATENT DOCUMENTS

- D. 81,668 7/1930 Seyfferle D34/42
- 97,836 12/1869 Venet 217/122
- 107,446 9/1870 Carman et al. 217/122
- 4,461,801 7/1984 Graham 217/122 X

OTHER PUBLICATIONS

Royal Cathay Cat., 1982, p. 107, shown by arrow.

Antique Baskets & Basketery, 1985, p. 11.
Royal Cathay Cat., 1982, p. 72, Item No. B.

Primary Examiner—Bernard Ansher
Assistant Examiner—Prabhakar Deshmukh
Attorney, Agent, or Firm—Alan H. Levine

[57] CLAIM

The ornamental design for a wicker container, as shown and described.

DESCRIPTION

FIG. 1 is a perspective view of a wicker container showing my new design;
 FIG. 2 is a front elevation thereof;
 FIG. 3 is a rear side elevation thereof;
 FIG. 4 is a left side elevation thereof;
 FIG. 5 is a right side elevation thereof;
 FIG. 6 is a top plan view thereof;
 FIG. 7 is a bottom plan view thereof;
 FIG. 8 is a perspective view thereof, in open position; and
 FIG. 9 is a perspective view of a modified form of FIG. 1 container bottom.

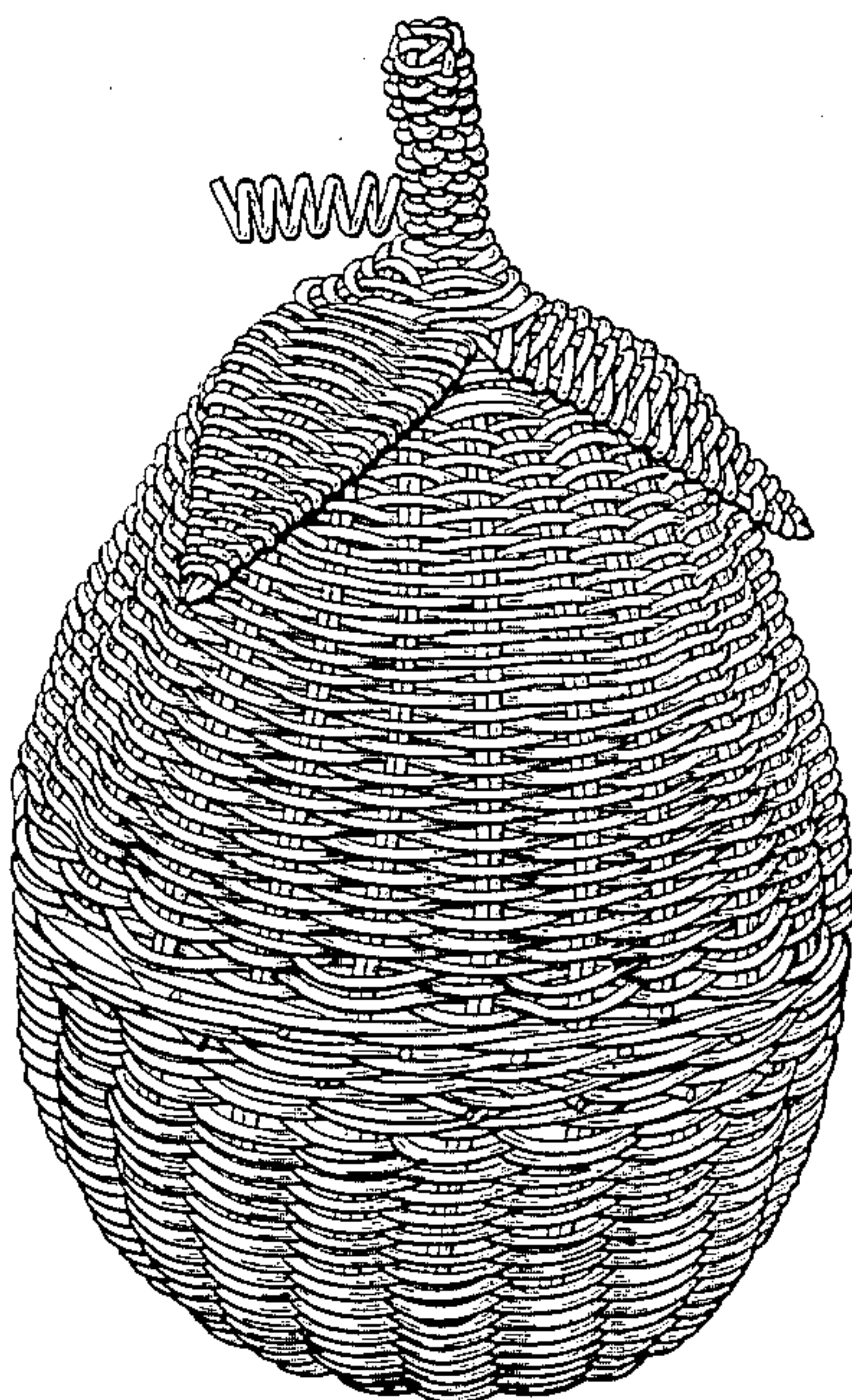

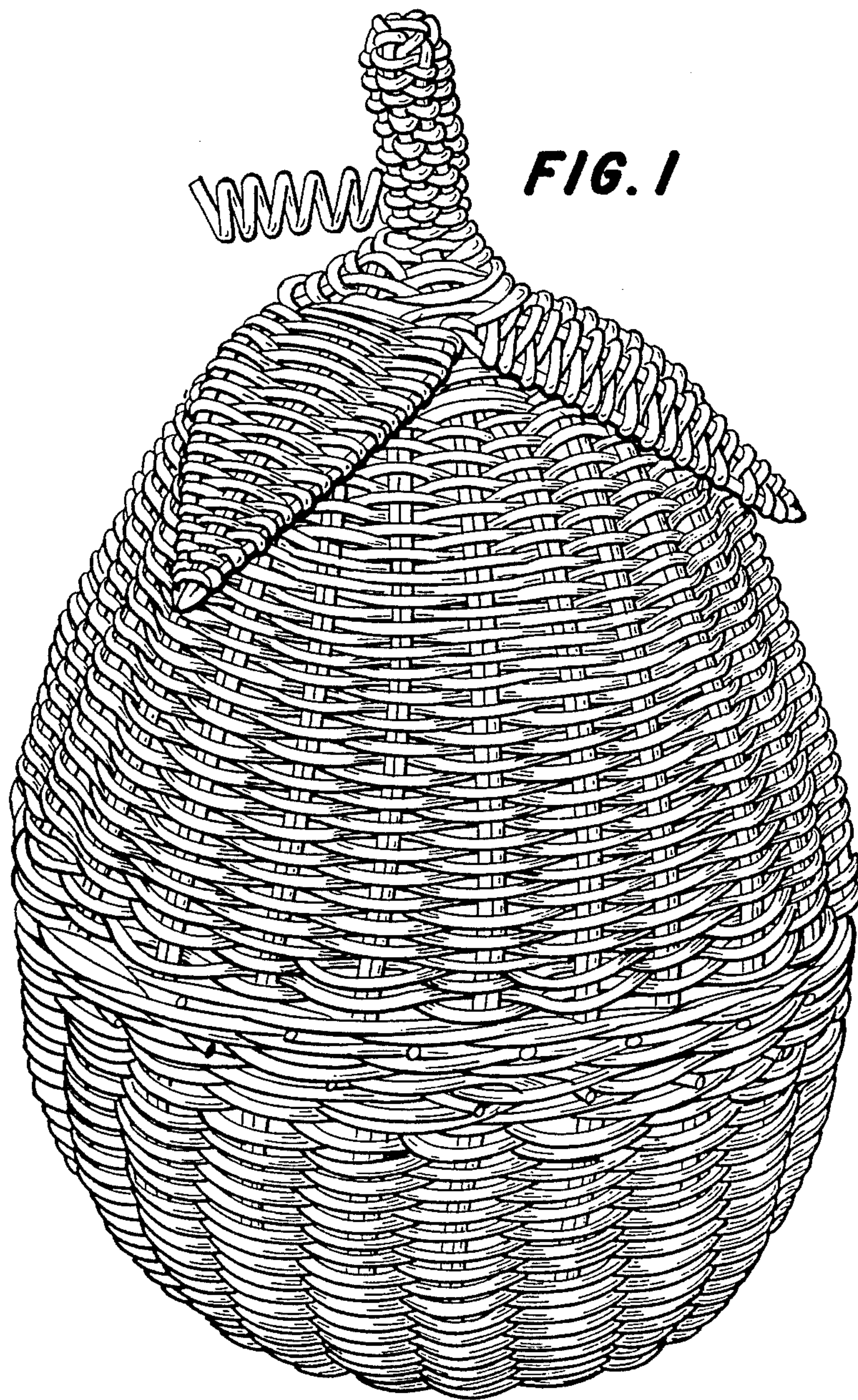

FIG. 1

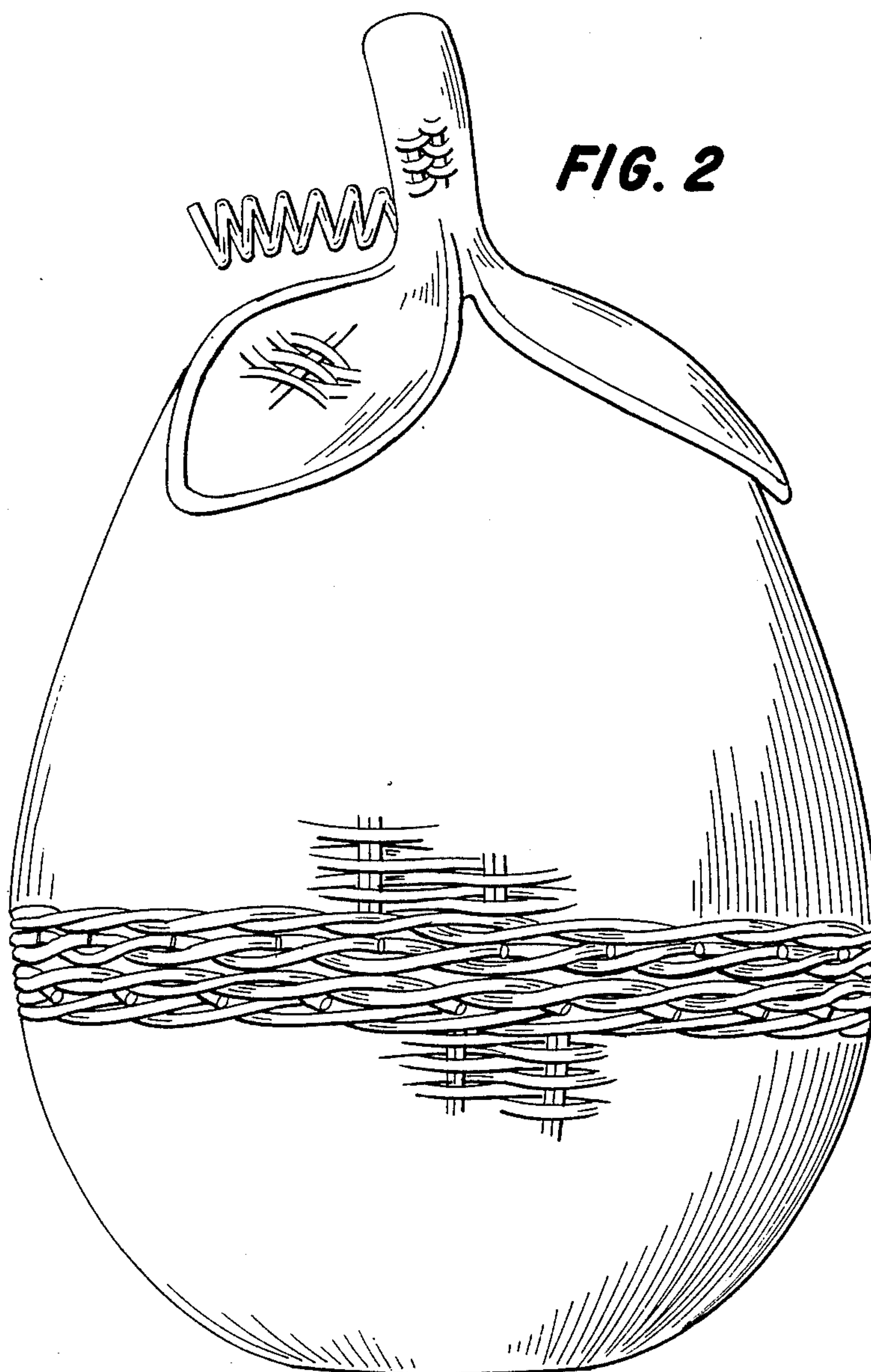

FIG. 3

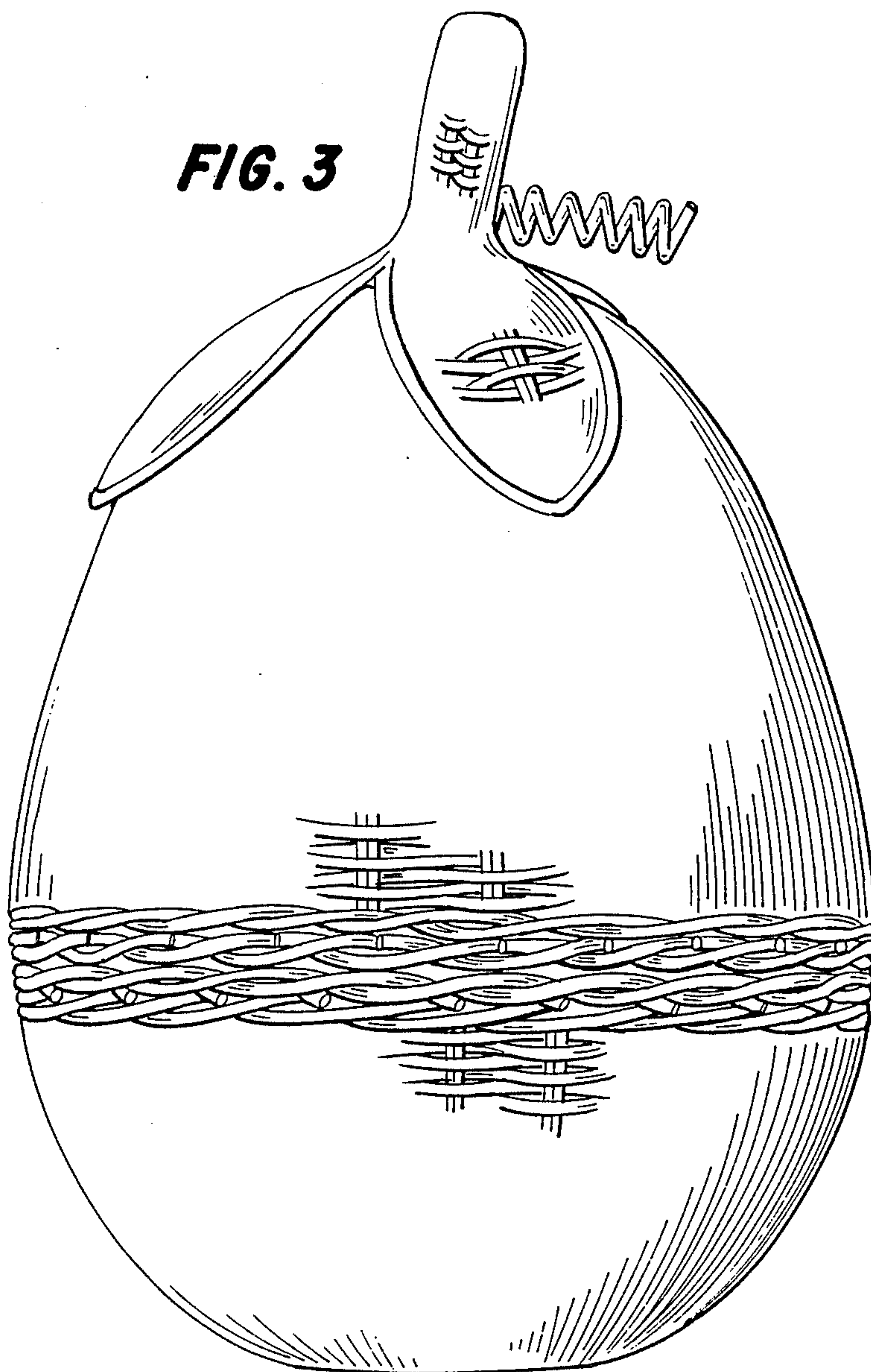

FIG. 4

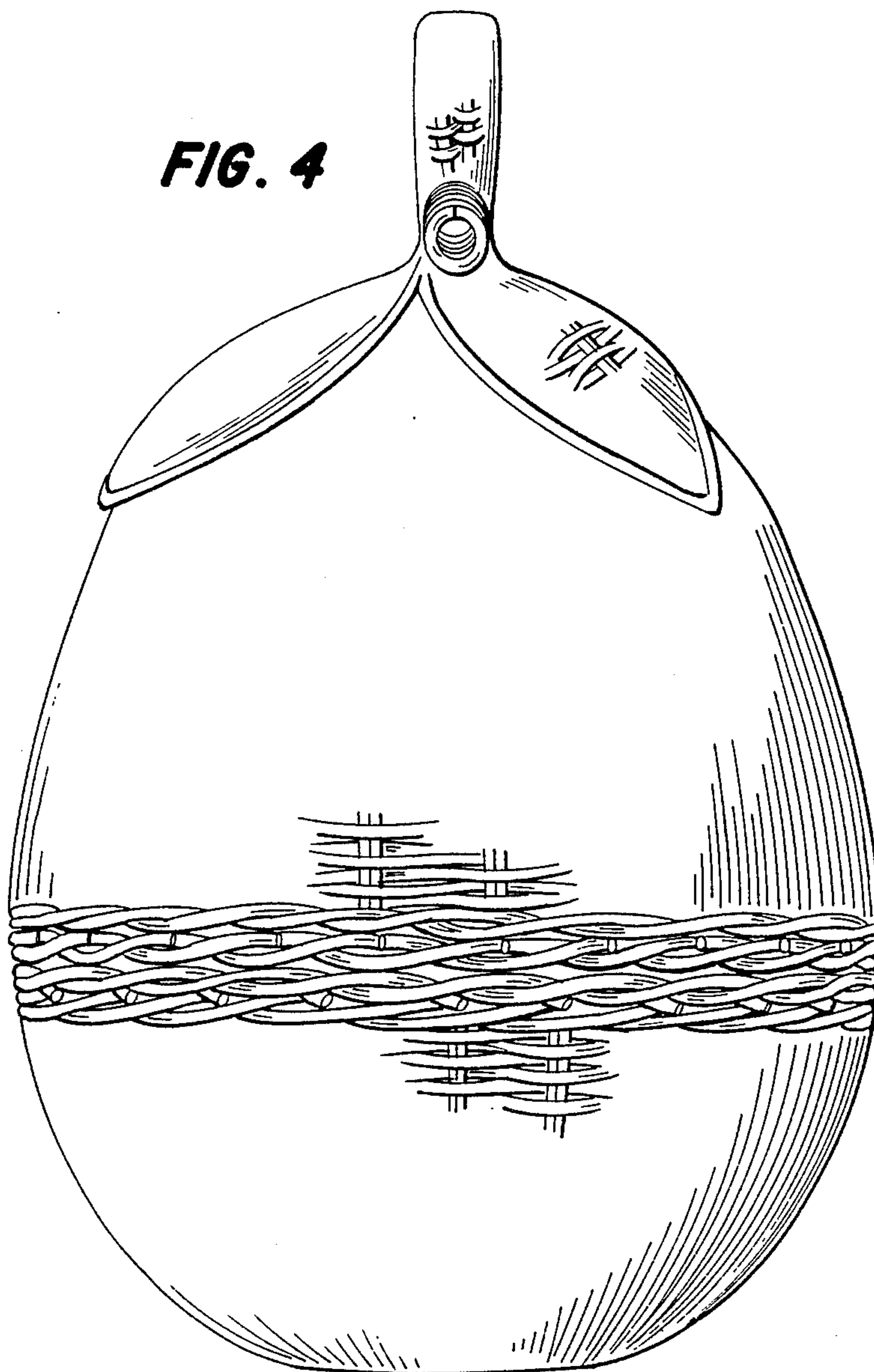
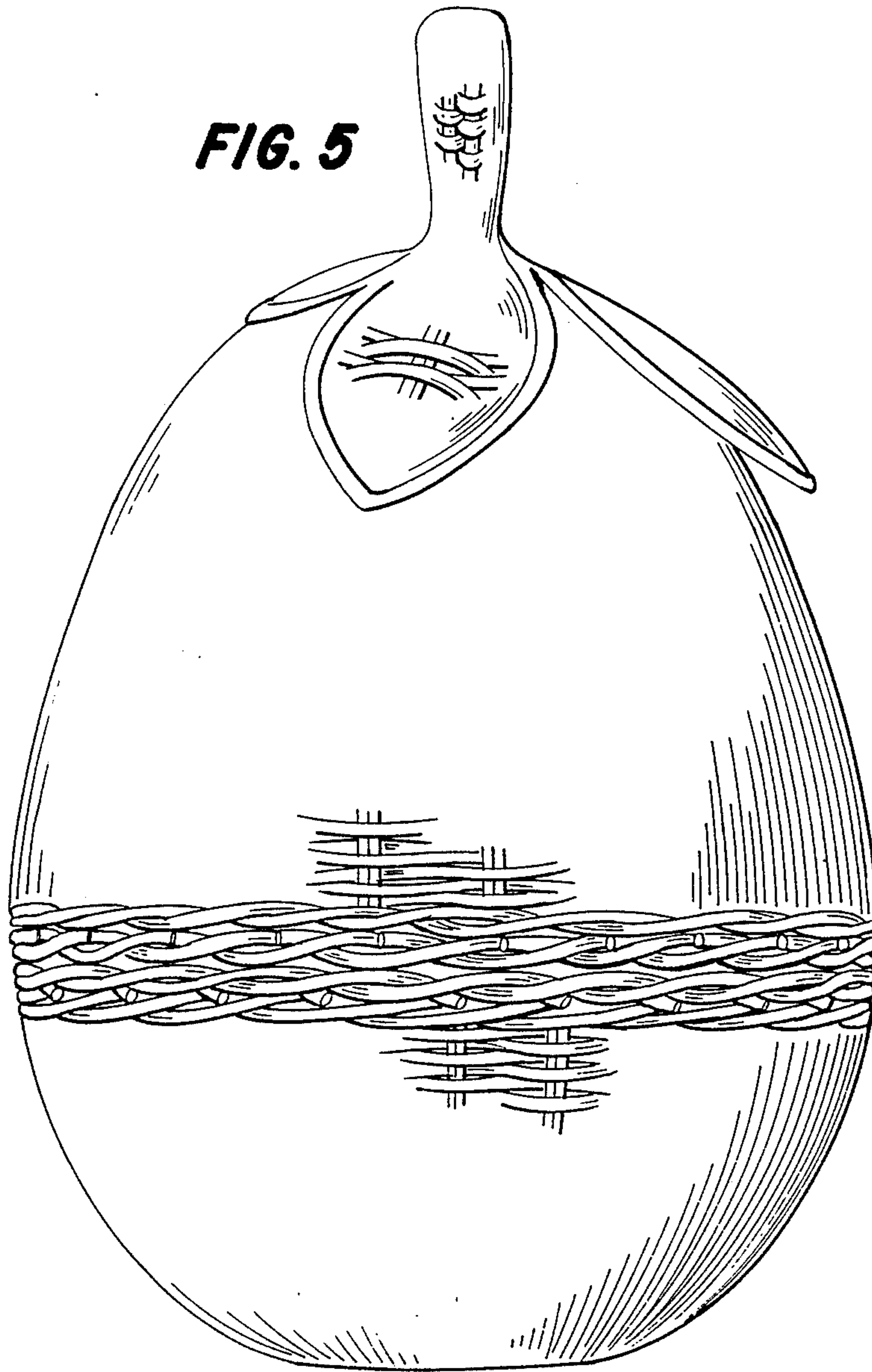

FIG. 5



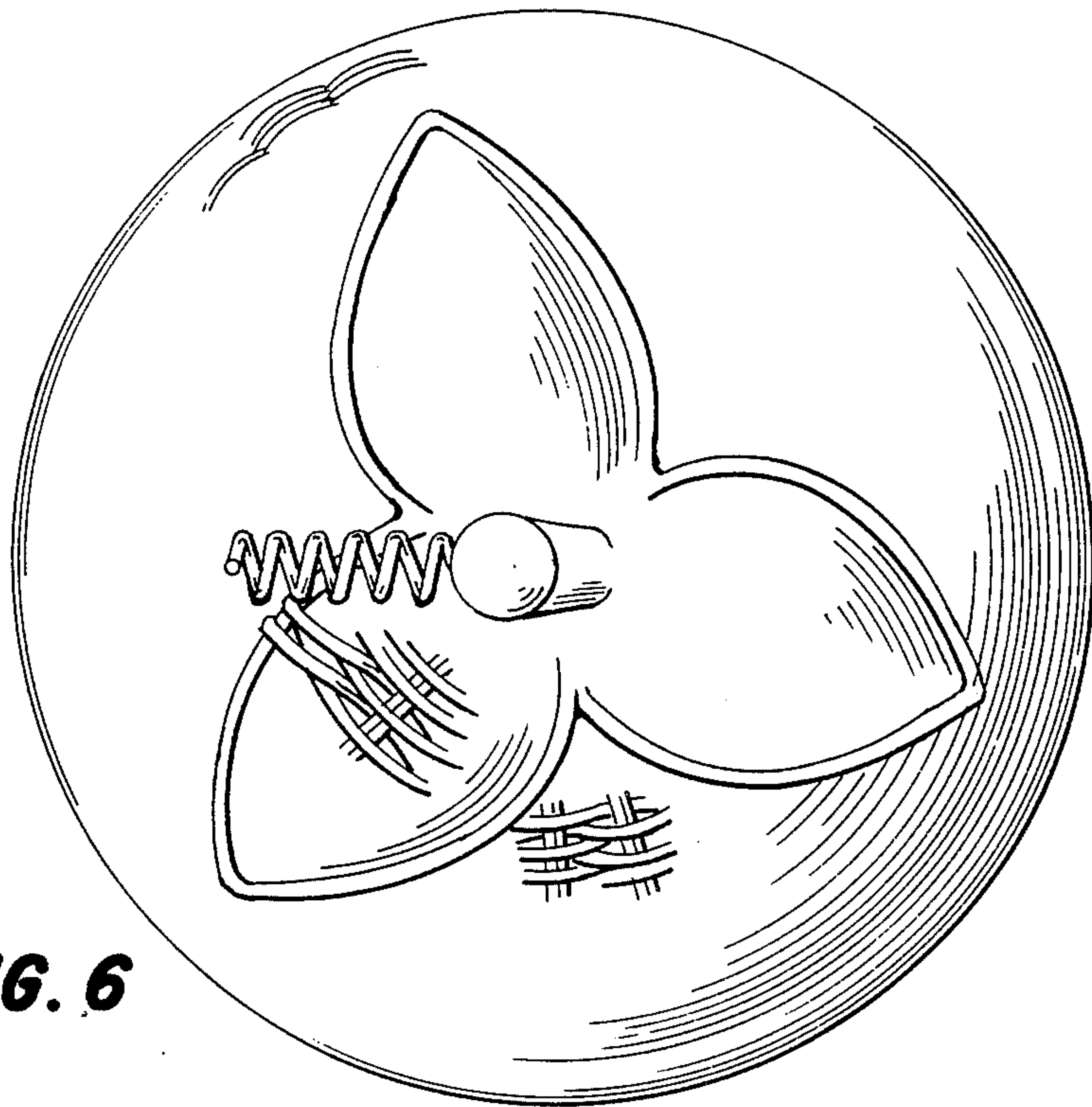

FIG. 6

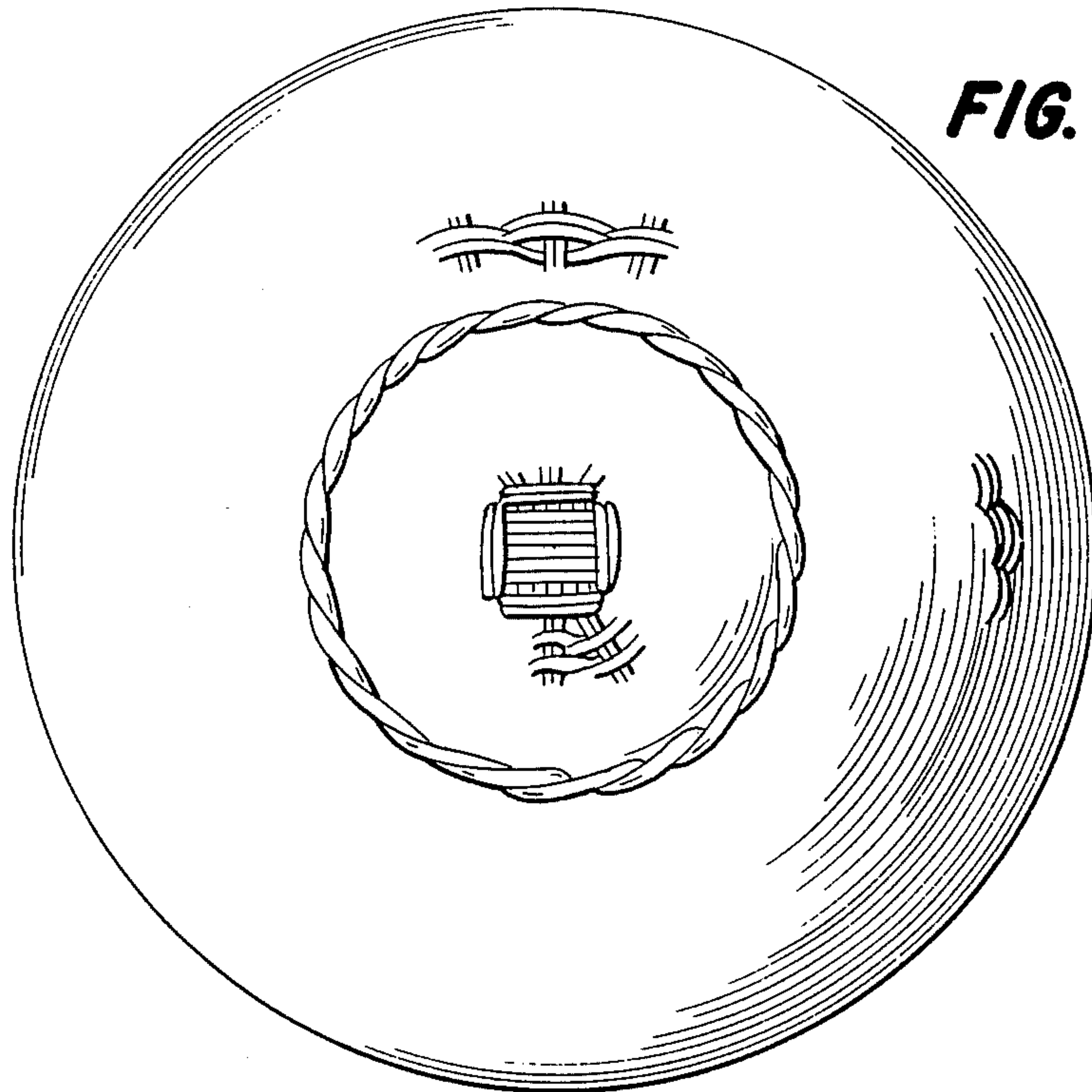

FIG. 7

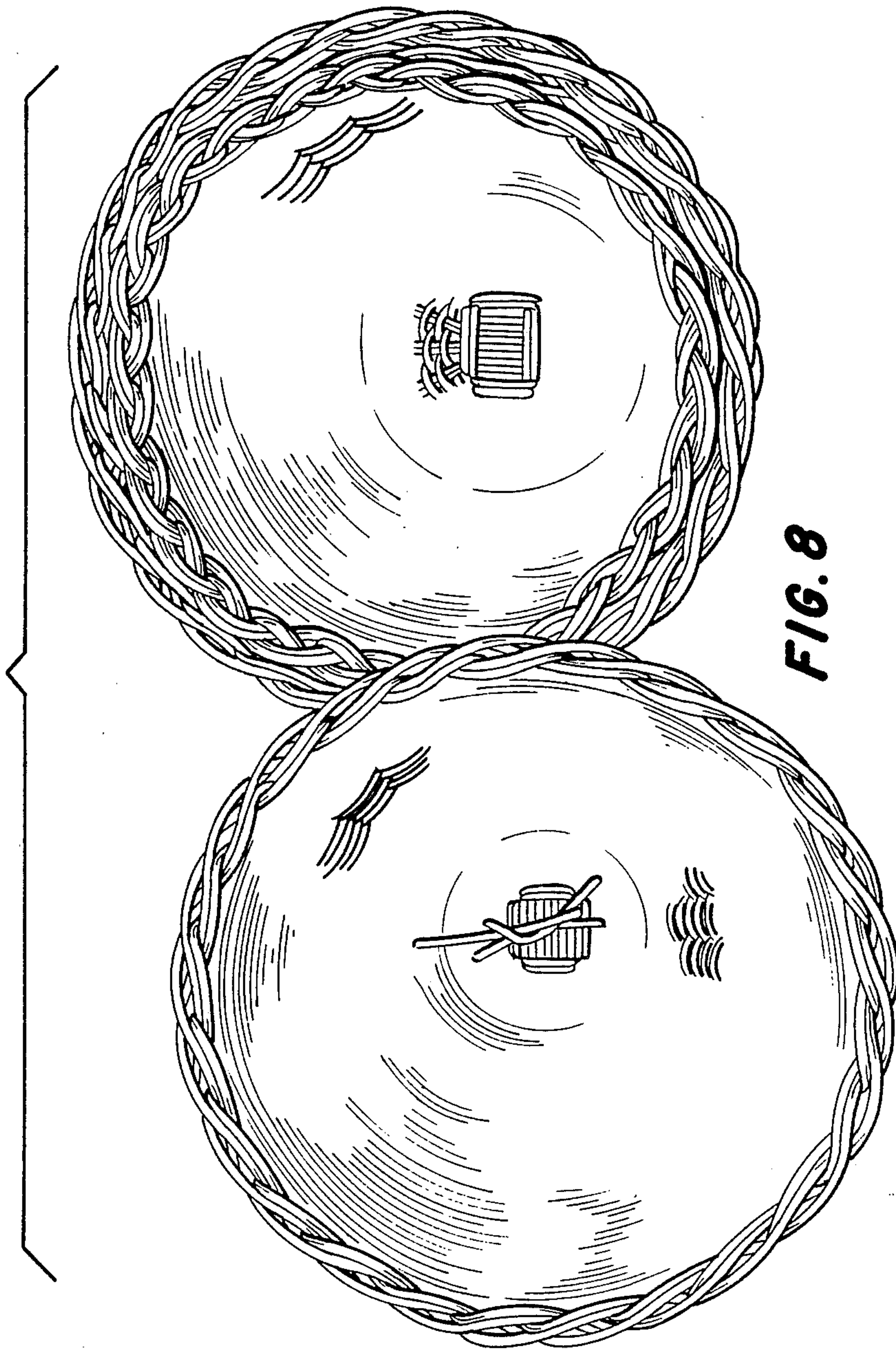

FIG. 8

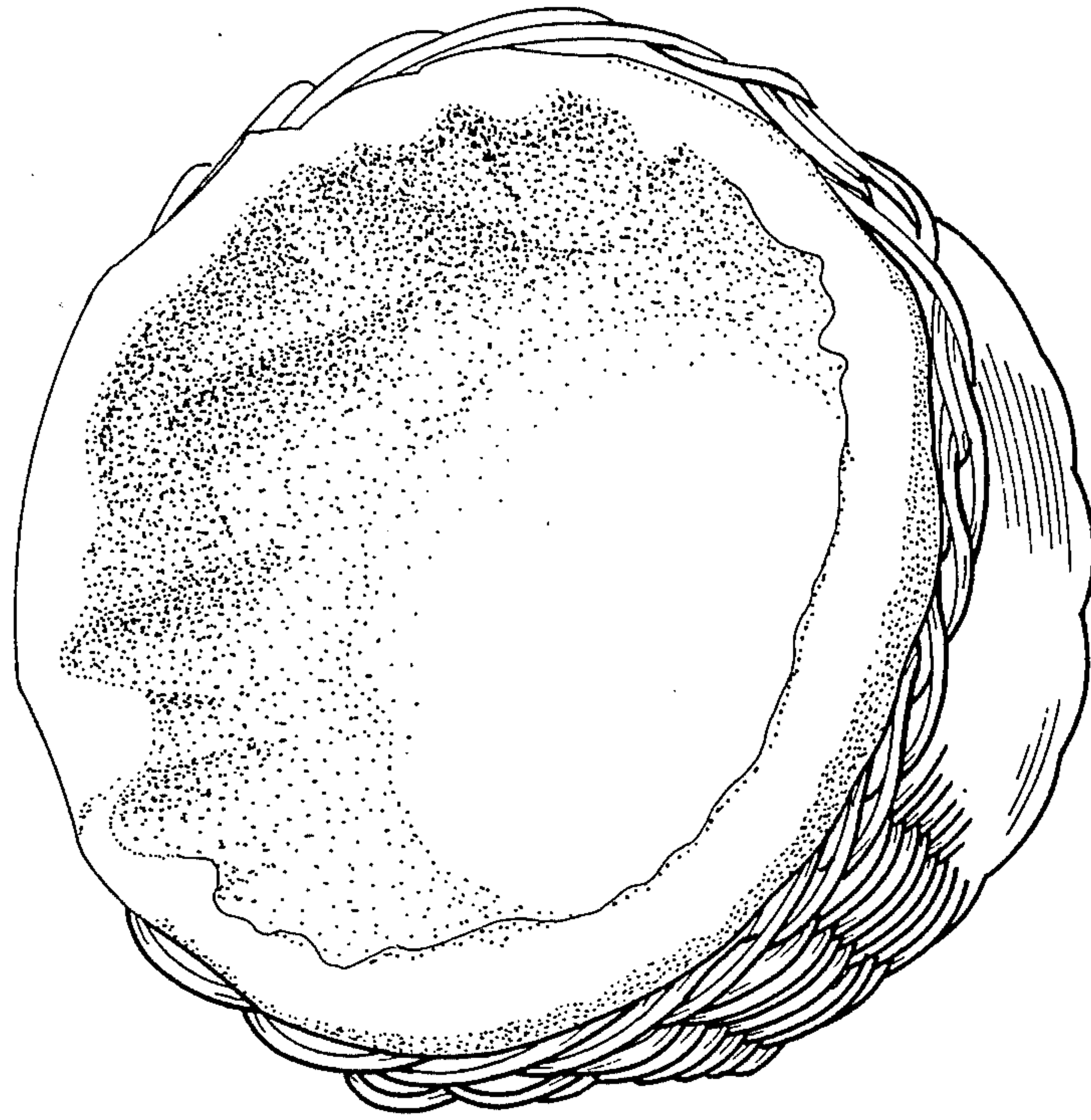

FIG. 9