

[54] **PRODUCT DISPLAY MOUNTING BRACKET FOR PROVIDING PRICE TAGS OR CODED INVENTORY LABELS**

*Assistant Examiner*—M. H. Tung  
*Attorney, Agent, or Firm*—David O'Reilly

[76] Inventor: **Joseph Crowley**, 9639 Wystone Ave., Northridge, Calif. 91324

[57] **CLAIM**

The ornamental design for product display mounting bracket for providing price tags or coded inventory labels, as shown and described.

[\*\*] Term: **14 Years**

**DESCRIPTION**

[21] Appl. No.: **946,280**

FIG. 1 is a perspective view of a product display mounting bracket for providing price tags or coded inventory labels showing my new design, on a reduced scale, the broken lines are shown for illustrative purposes only and form no part of the claimed design; FIG. 2 is a front elevational view thereof, on an enlarged scale;

[22] Filed: **Dec. 23, 1986**

[52] U.S. Cl. .... **D8/354**

FIG. 3 is rear elevational view thereof;

[58] Field of Search ..... D8/349, 354, 380, 373; 248/300, 213.2, 309.1, 231.8; D20/43

FIG. 4 is a top plan view thereof;

[56] **References Cited**

**U.S. PATENT DOCUMENTS**

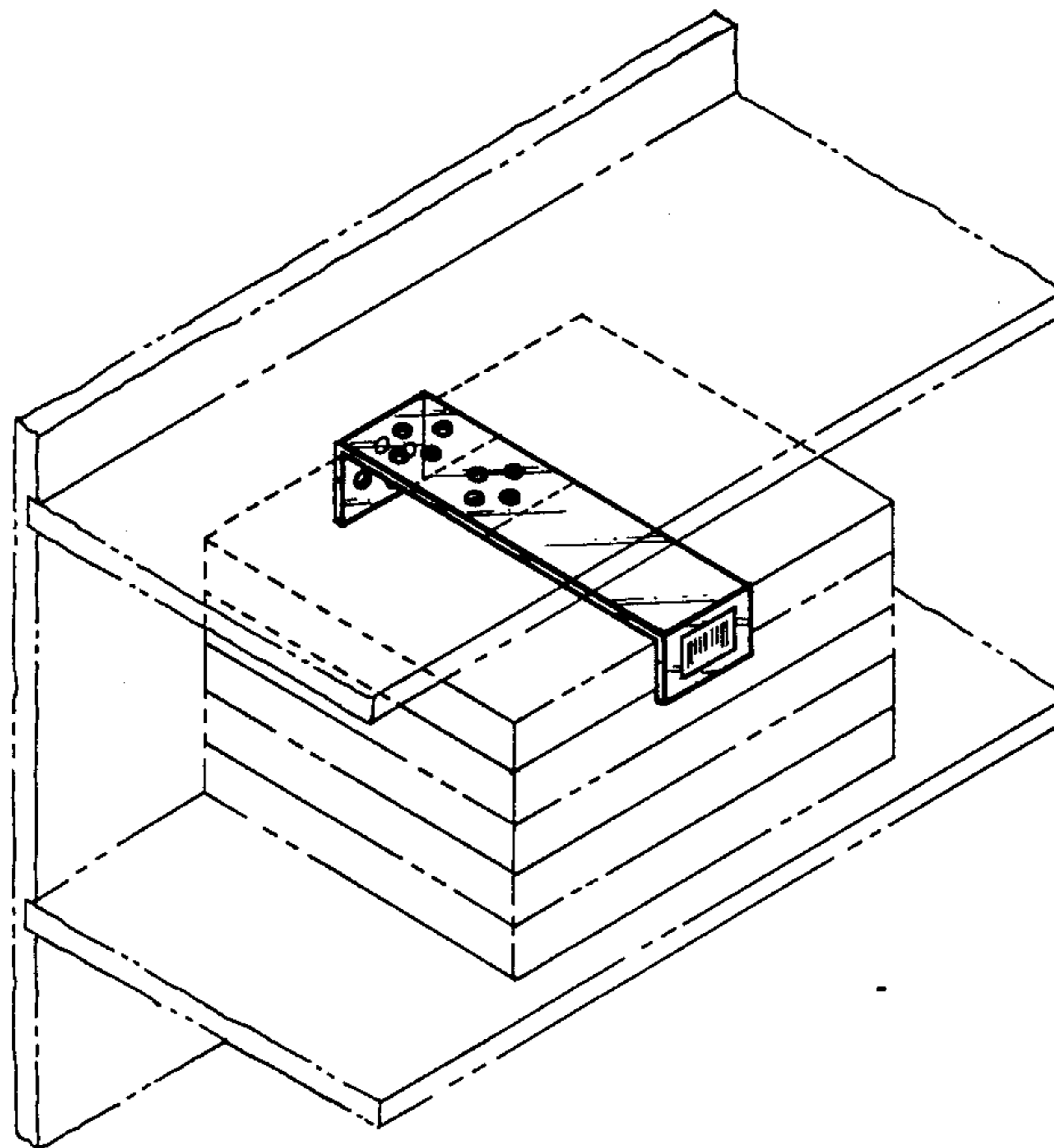
D. 244,748	6/1977	Canterbury	.....	D8/354	X
D. 291,315	8/1987	Belford et al.	.....	D8/349	X
1,066,706	7/1913	Caine	.....	248/300	X

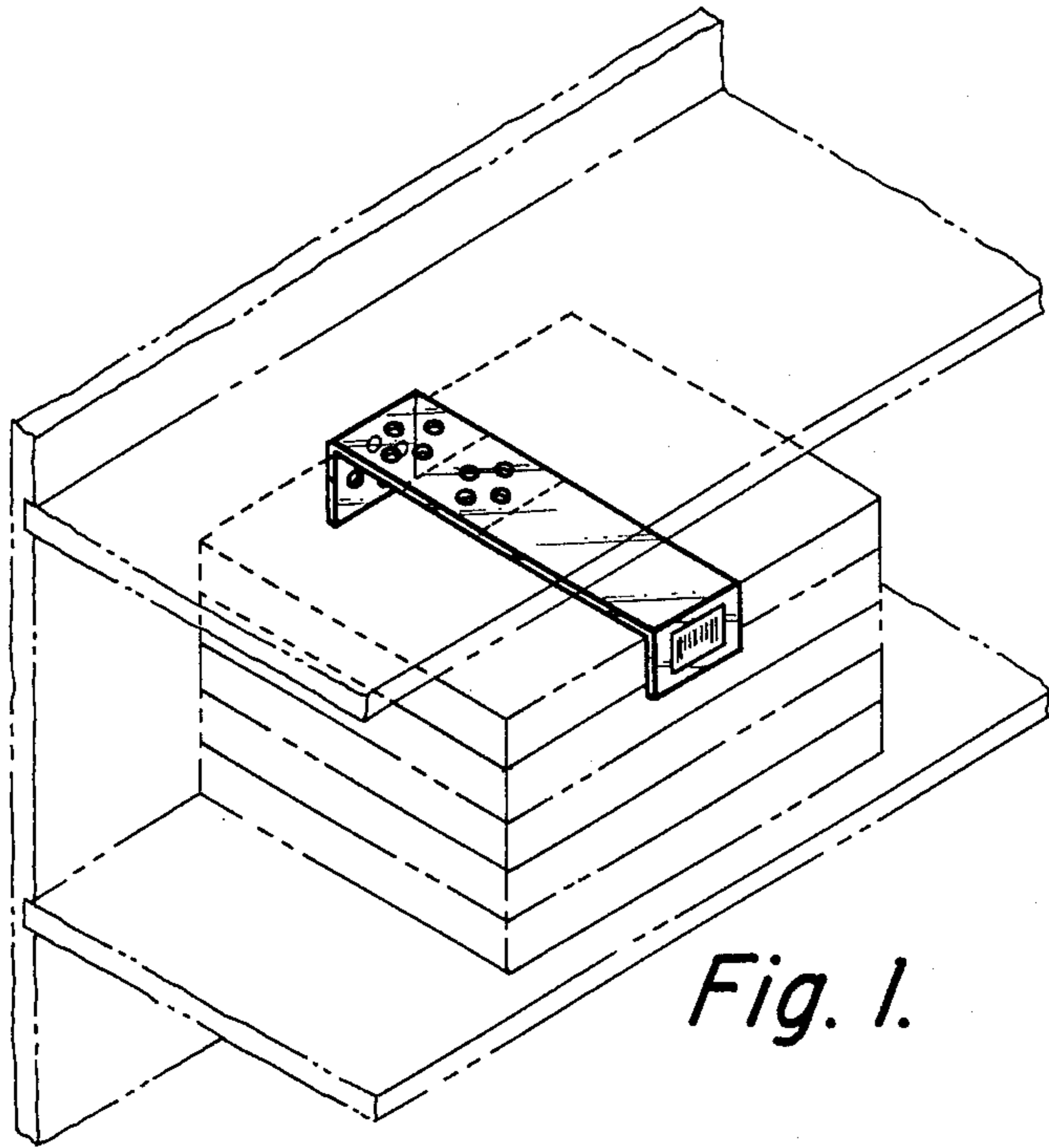
FIG. 5 is a left side elevational view thereof, the right side being a mirror image;

FIG. 6 is a bottom plan view thereof.

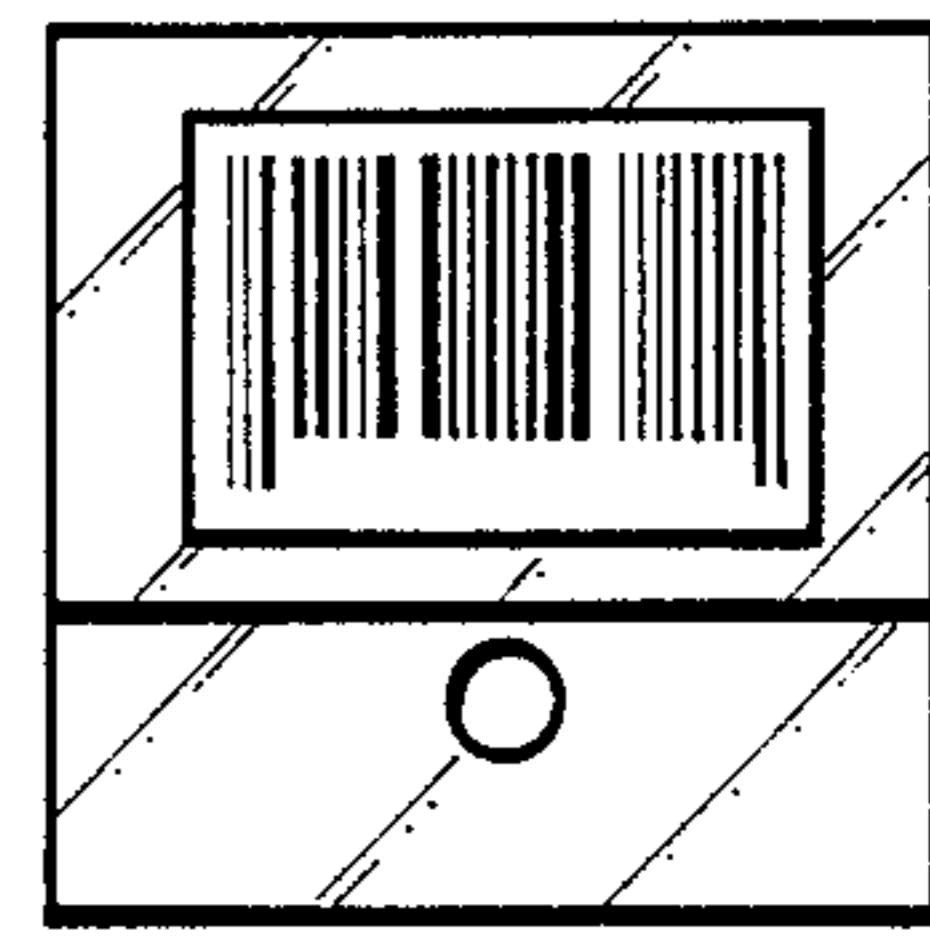
The broken lines on the bracket represent fold lines.

*Primary Examiner*—Susan J. Lucas

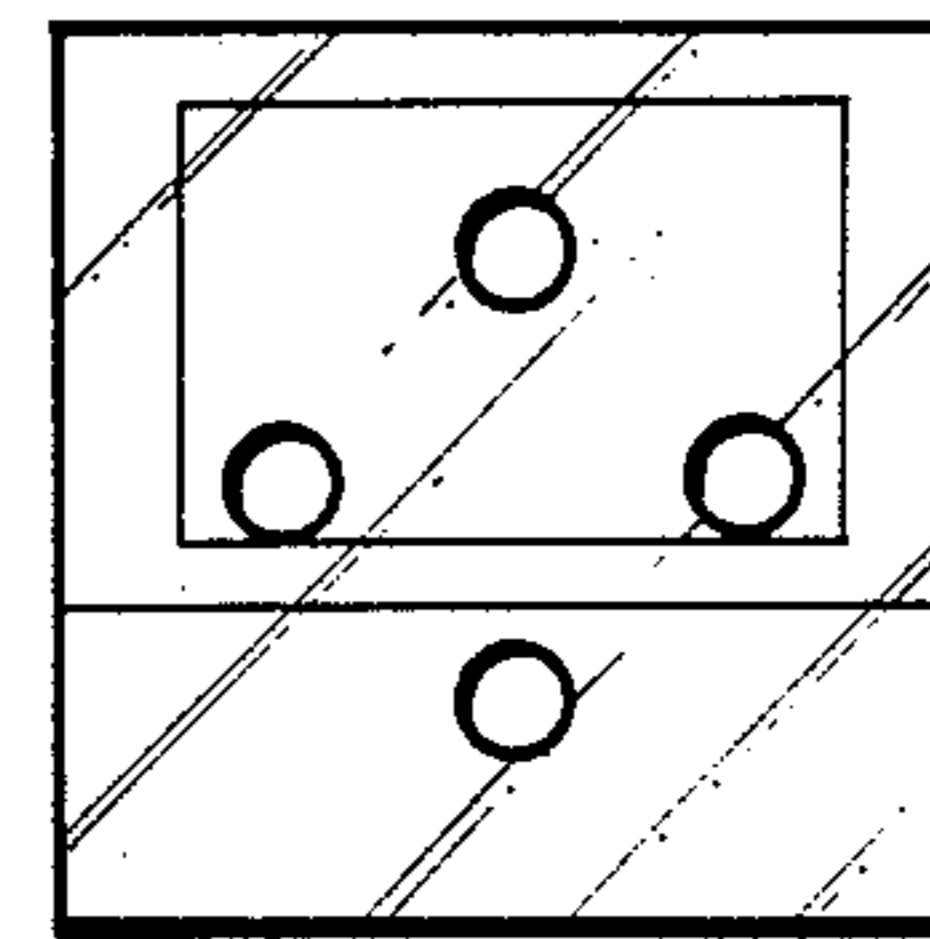




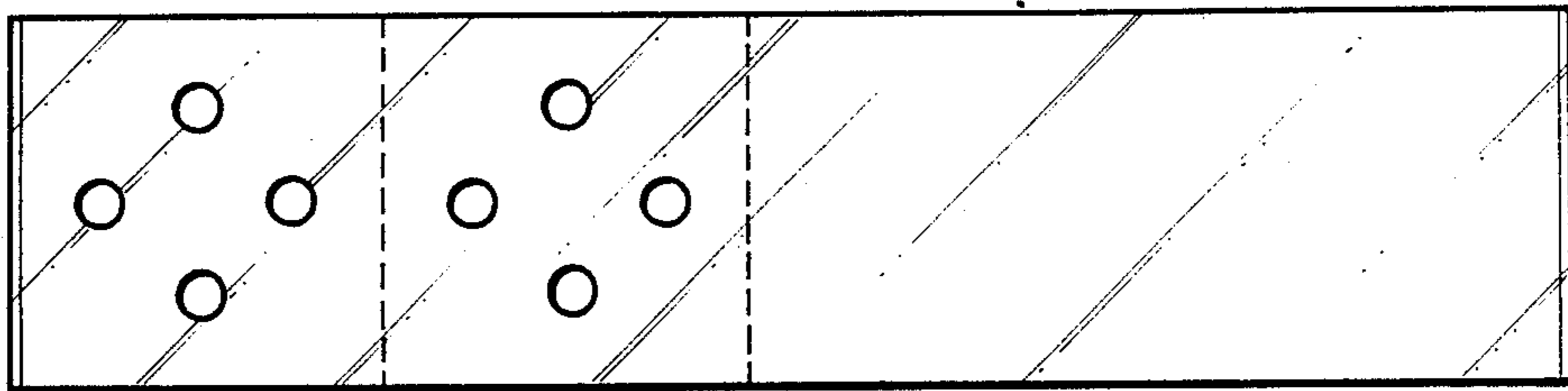
*Fig. 1.*



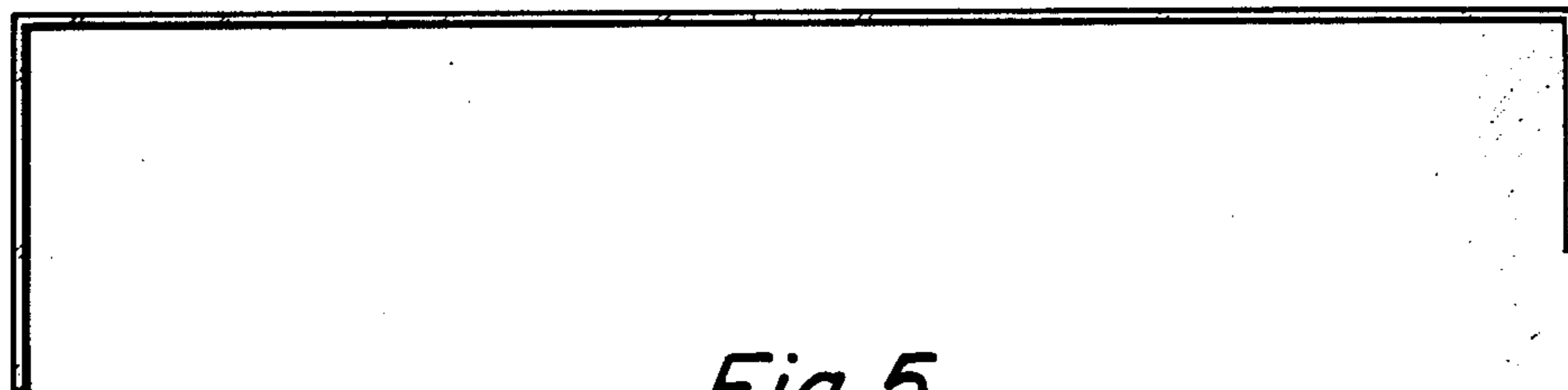
*Fig. 2.*



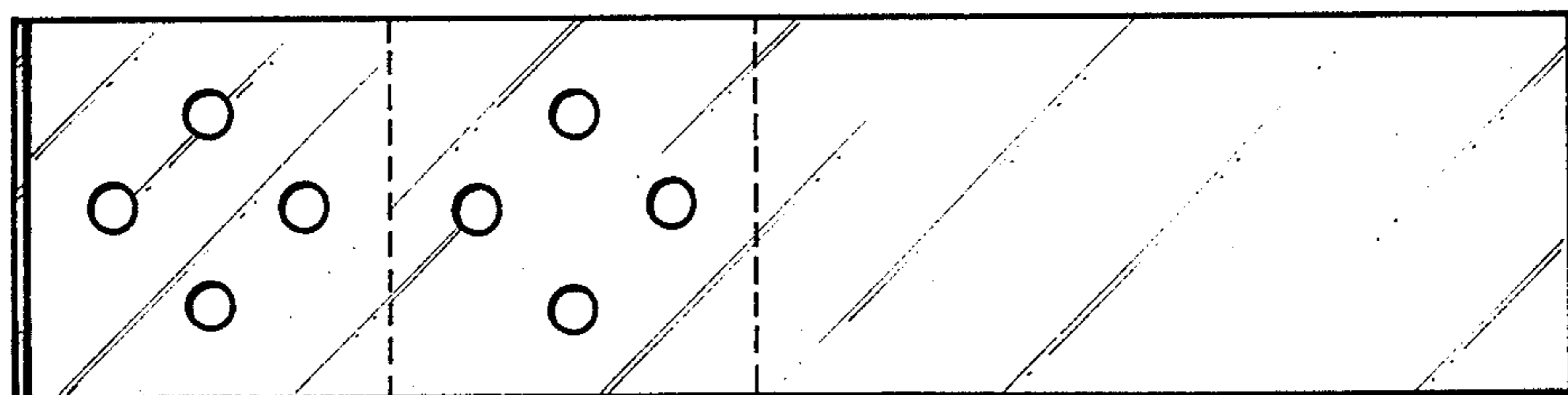
*Fig. 3.*



*Fig. 4.*



*Fig. 5.*



*Fig. 6.*