

[54] PICNIC COOLER

[75] Inventors: Robert R. Deines; William J. Steffes, both of Wichita, Kans.

[73] Assignee: Coleman Outdoor Products, Inc., Wichita, Kans.

[\*\*] Term: 14 Years

[21] Appl. No.: 120,010

[22] Filed: Nov. 13, 1987

[52] U.S. Cl. .... D7/605

[58] Field of Search ..... D7/76-77; 220/412, 23; 62/457.1, 457.7, 371; 206/545, 541, 549

[56] References Cited

U.S. PATENT DOCUMENTS

- D. 295,484 5/1988 Tarozzi et al. .... D7/77
- 4,648,512 3/1987 Tarozzi et al. .... D7/77 X

OTHER PUBLICATIONS

Thermos 1987 catalog, p. 2, Cooler.

Primary Examiner—Bernard Ansher  
Assistant Examiner—Terry A. Pfeffer

[57] CLAIM

The ornamental design for a picnic cooler, as shown and described.

DESCRIPTION

FIG. 1 is a top, front, left side perspective view of a picnic cooler showing our new design;  
 FIG. 2 is a top, front, right side perspective view thereof with the handle in lowered position;  
 FIG. 3 is a front elevational view thereof;  
 FIG. 4 is a right side elevational view thereof, the opposite side being a mirror image thereof;  
 FIG. 5 is a rear elevational view thereof;  
 FIG. 6 is a top plan view thereof;  
 FIG. 7 is a bottom plan view thereof;  
 FIG. 8 is a top, front, right side perspective view thereof with the lid reversed; and  
 FIG. 9 is a top plan view thereof of that shown in FIG. 8.

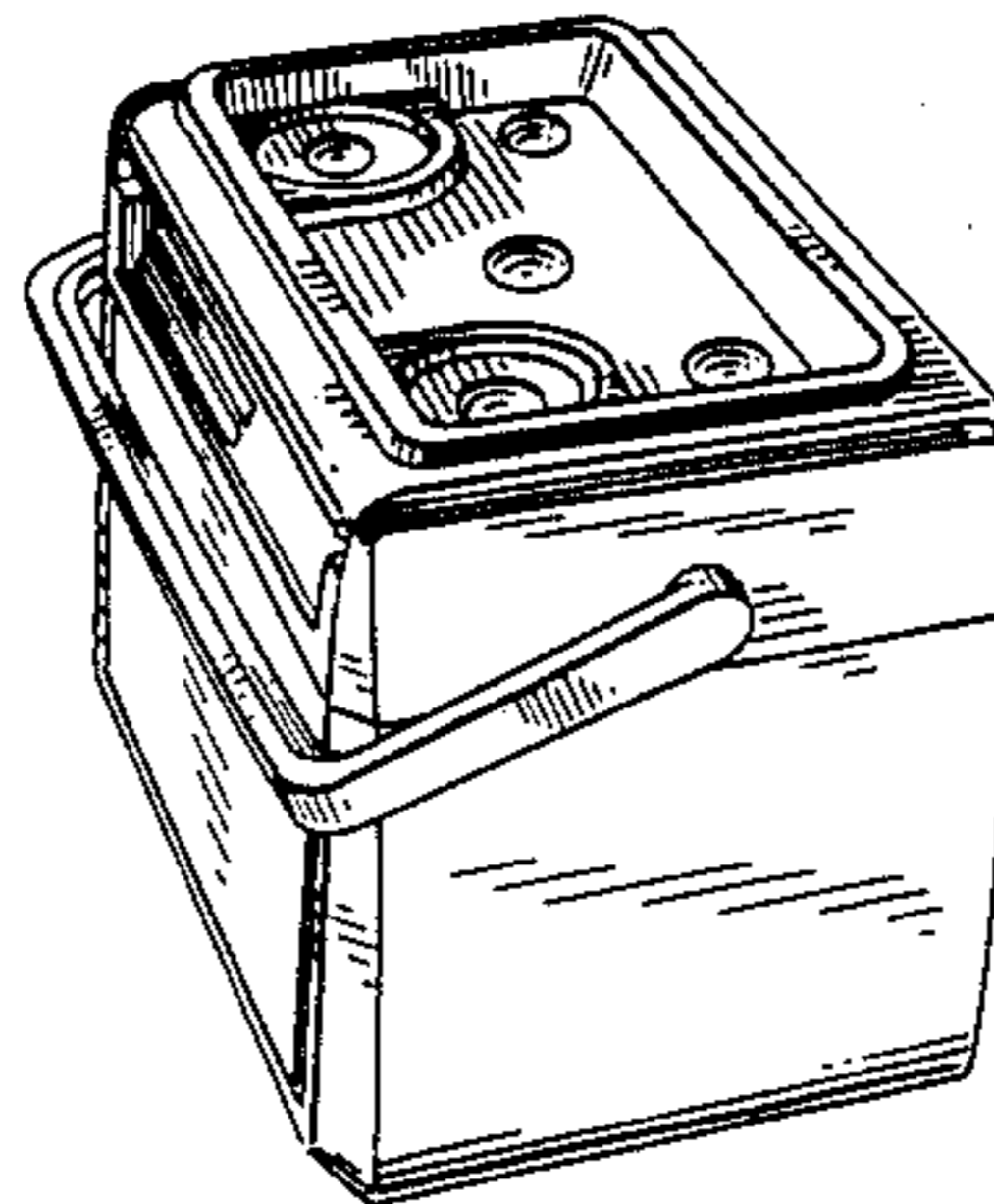
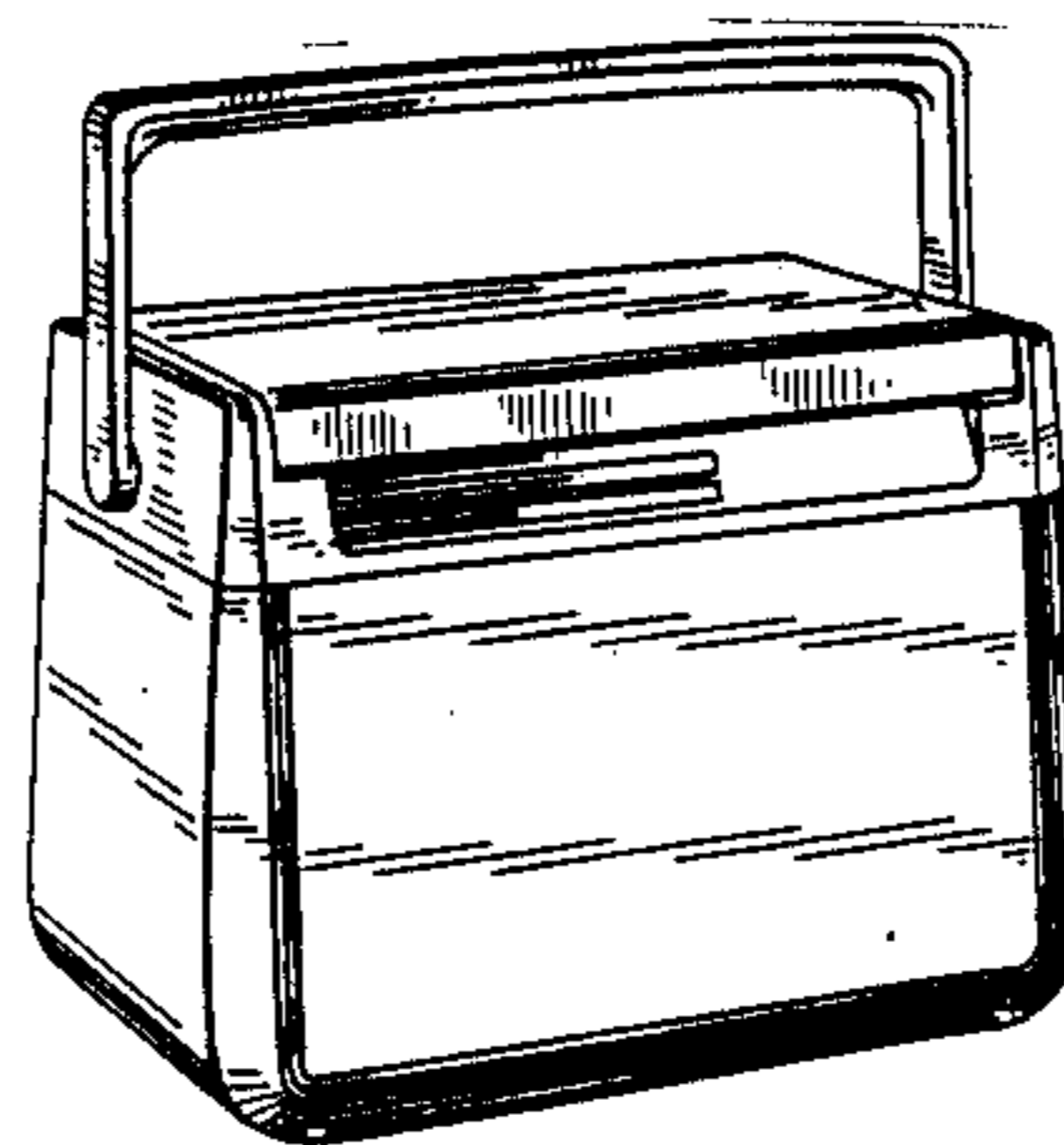

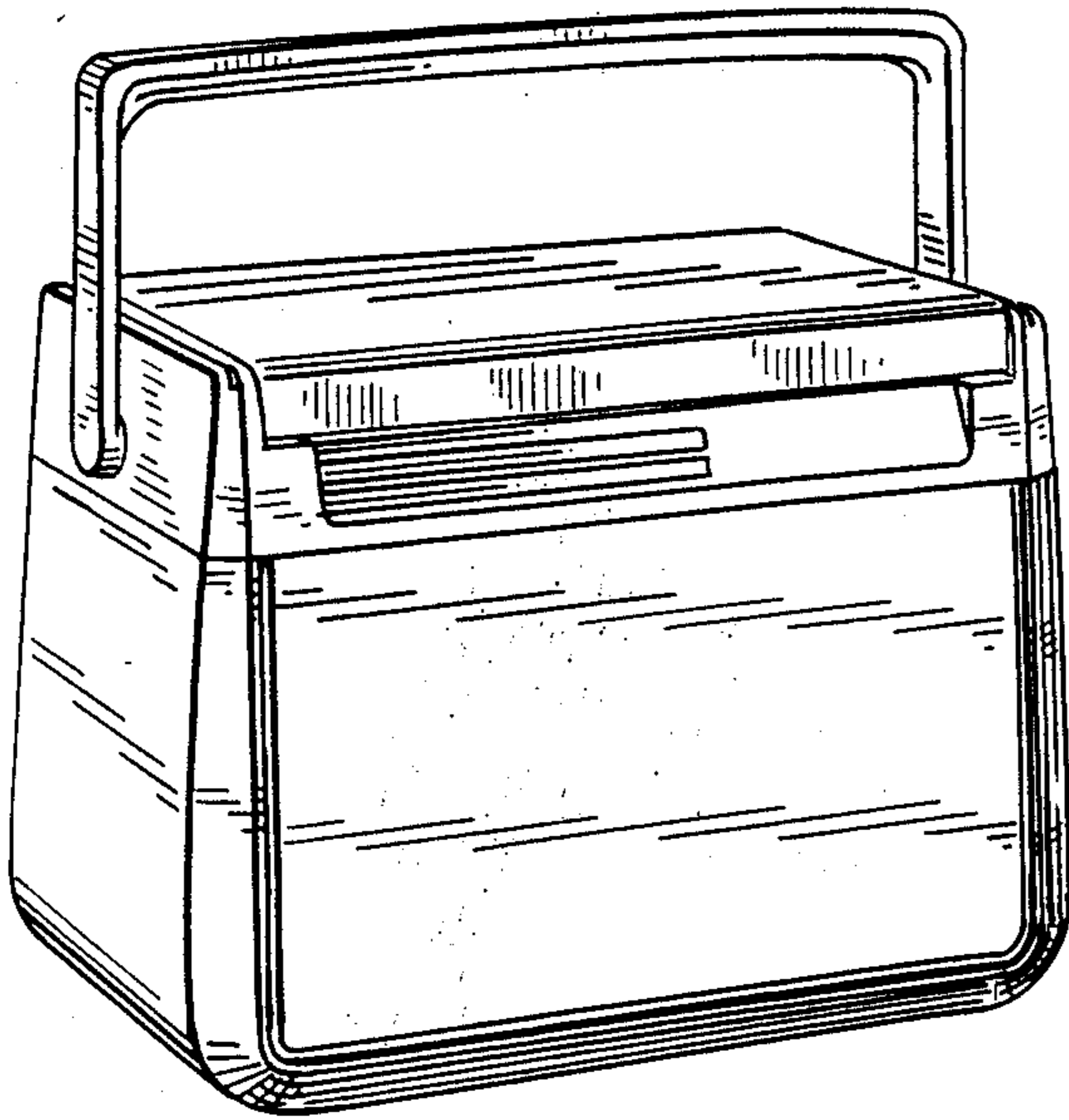

FIG. 1

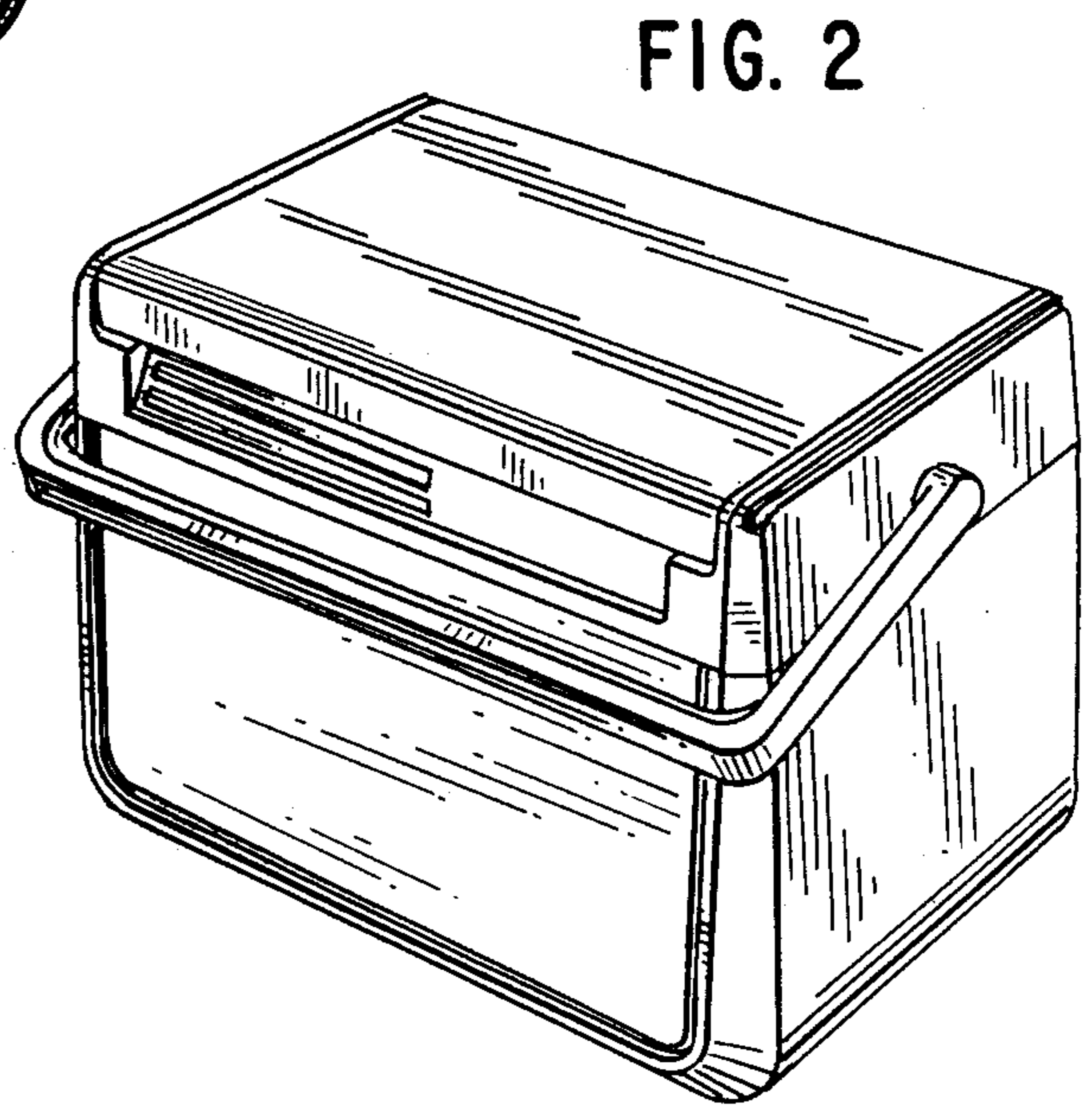

FIG. 2

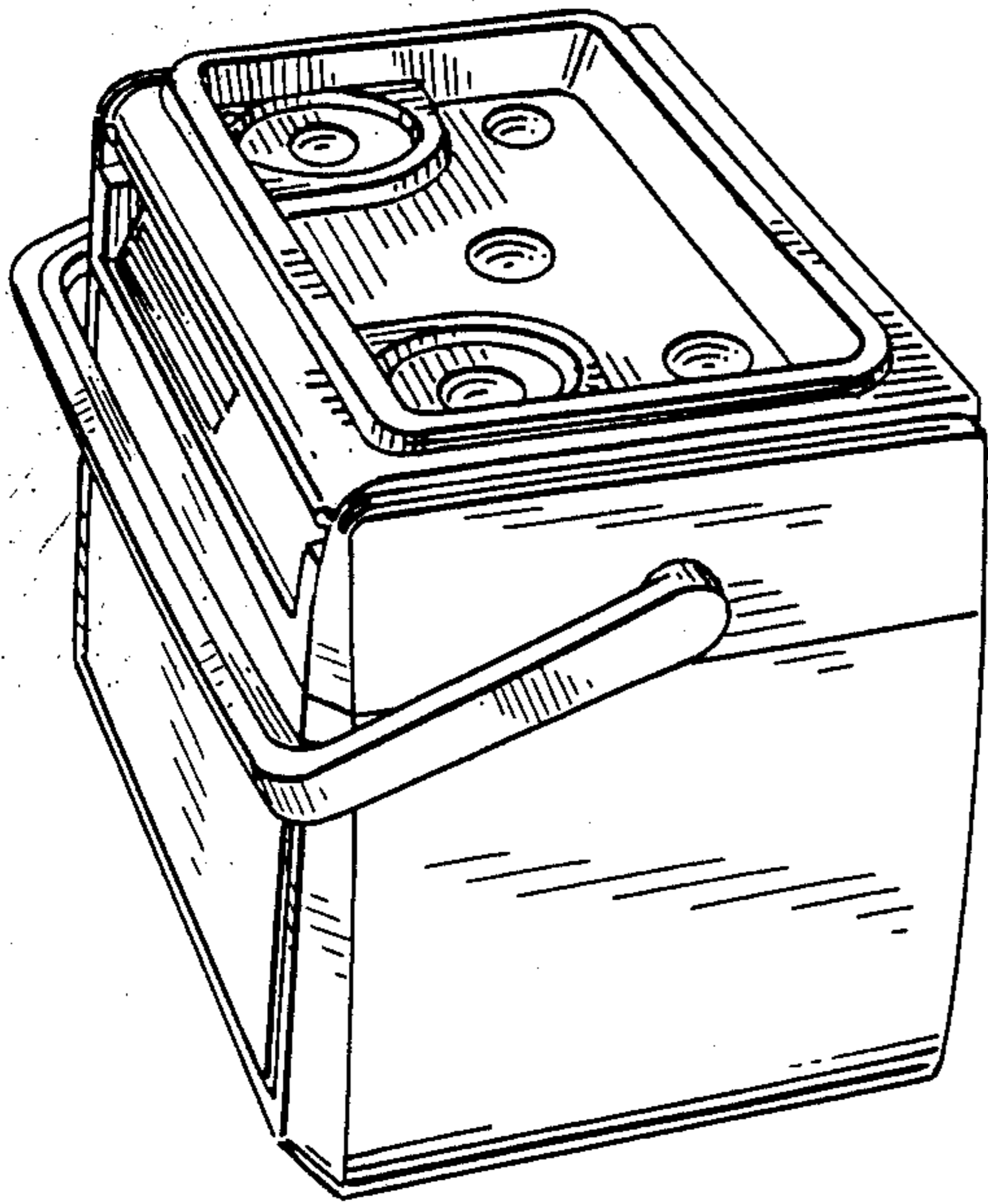

FIG. 8

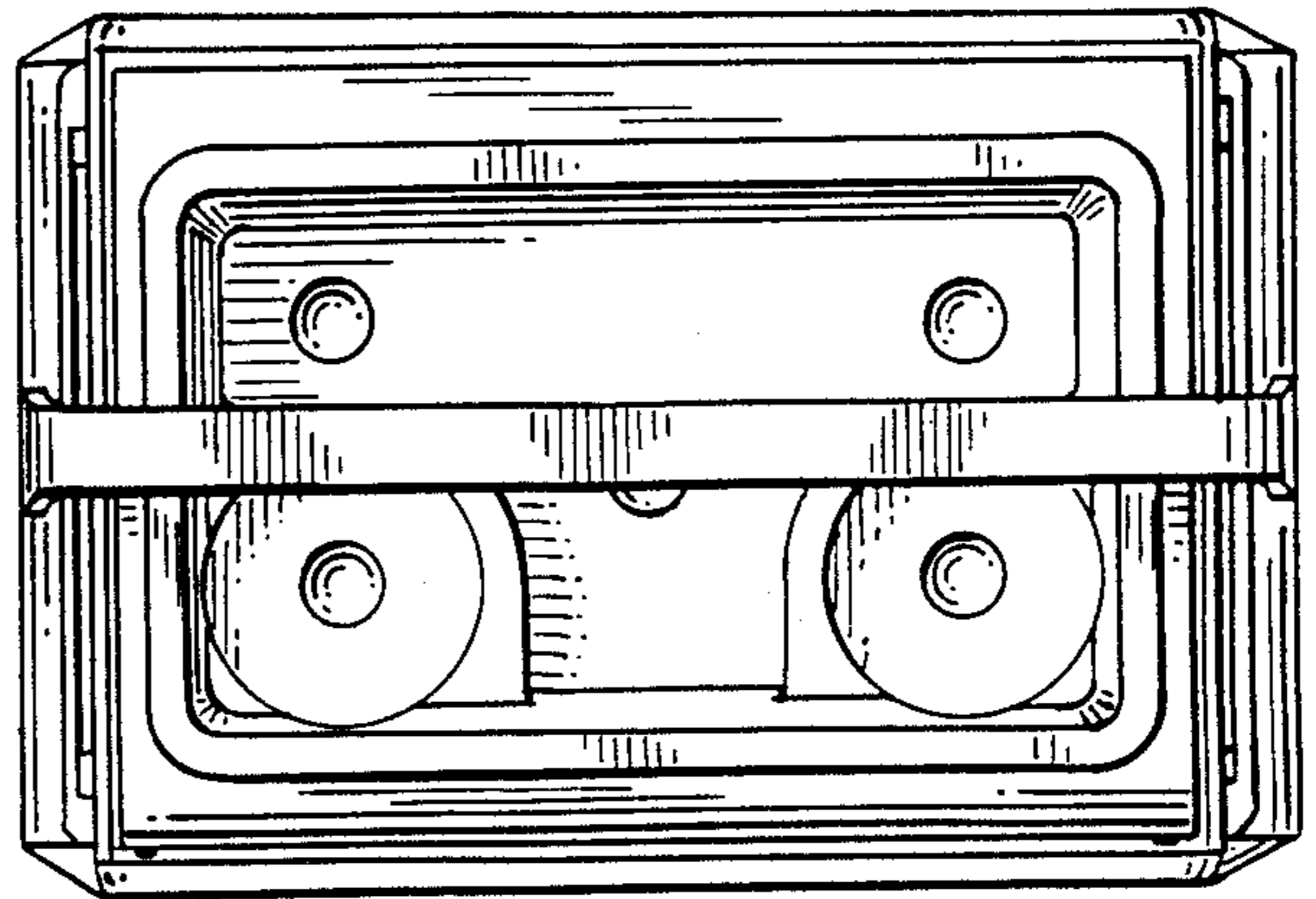

FIG. 9

FIG. 6

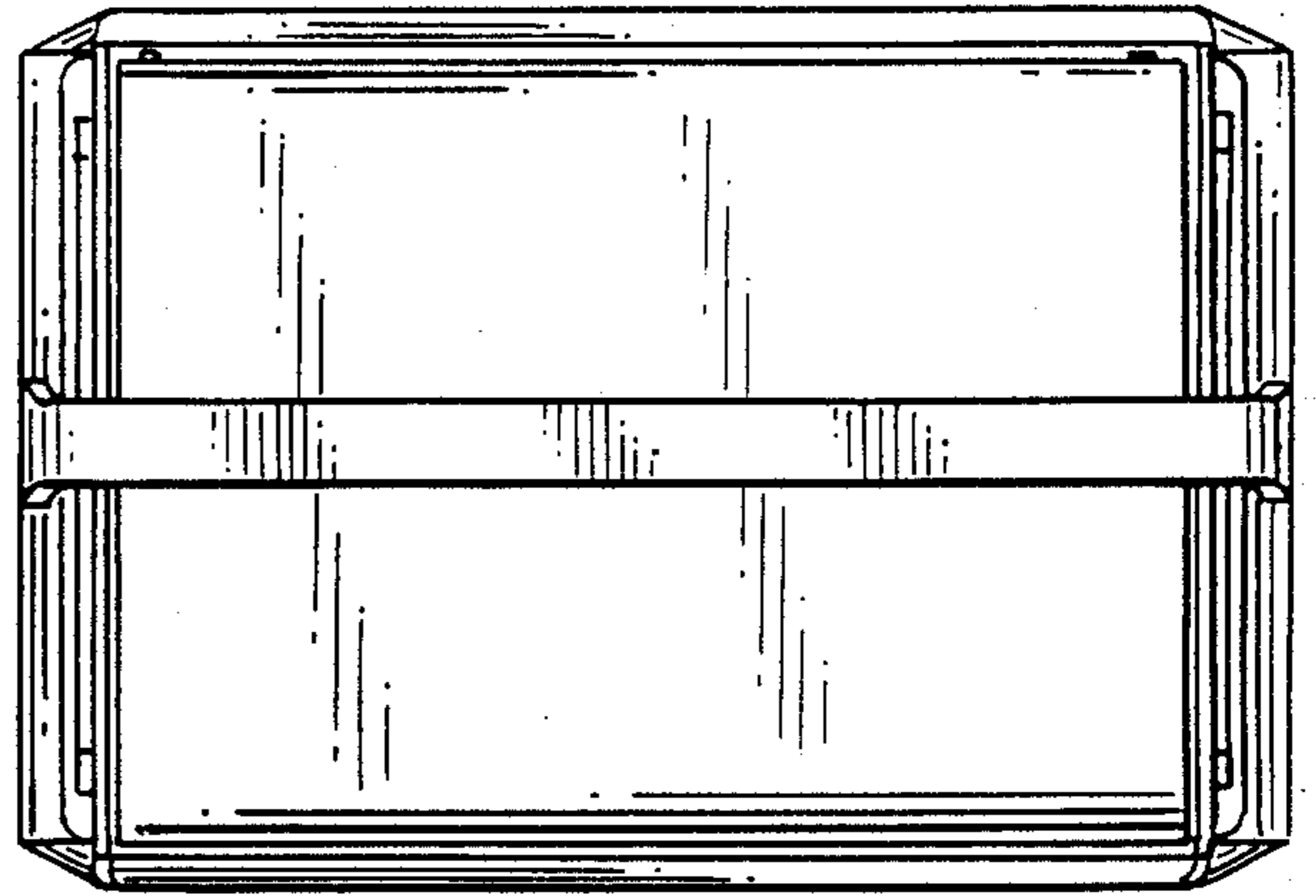

FIG. 4

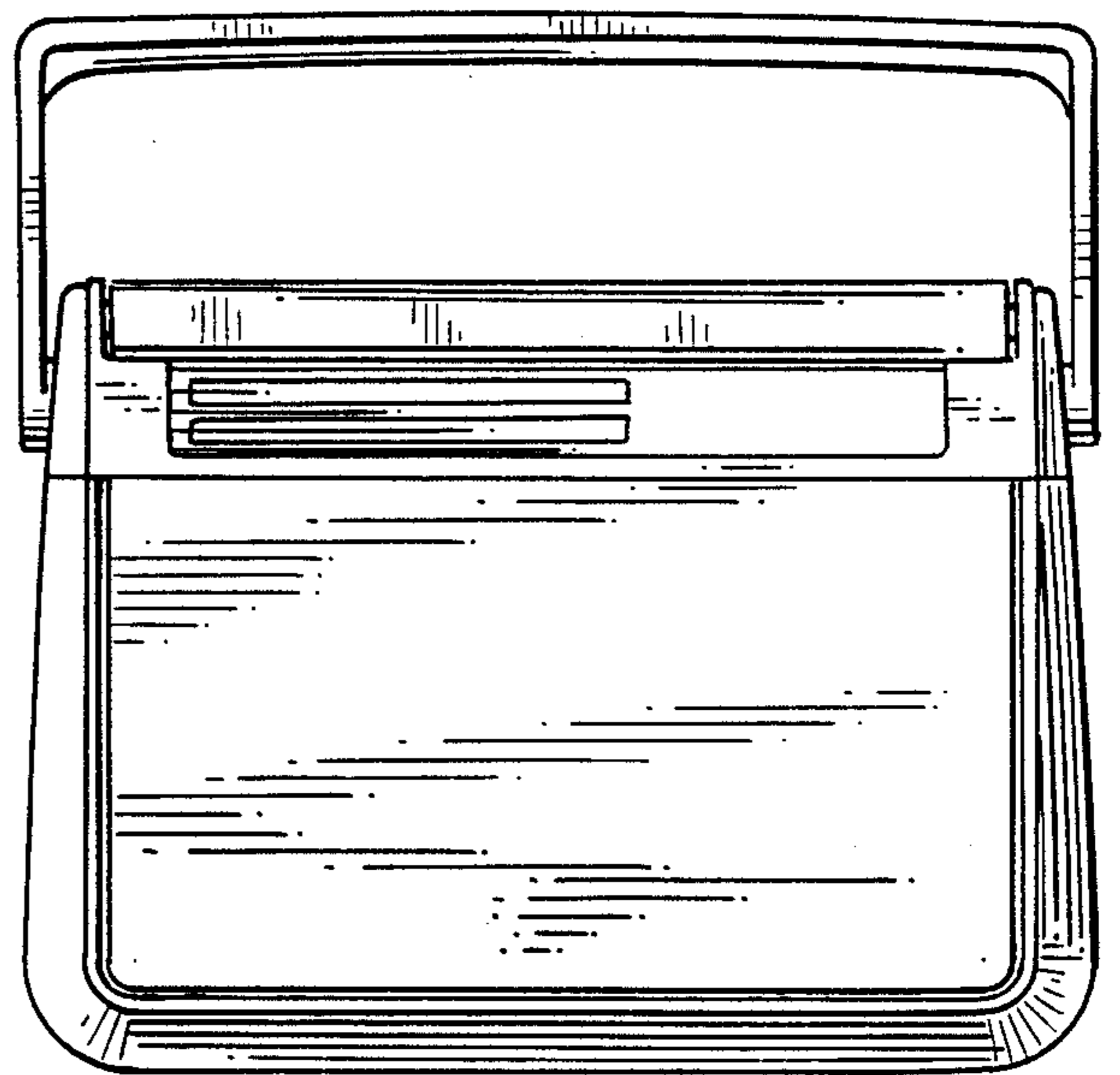
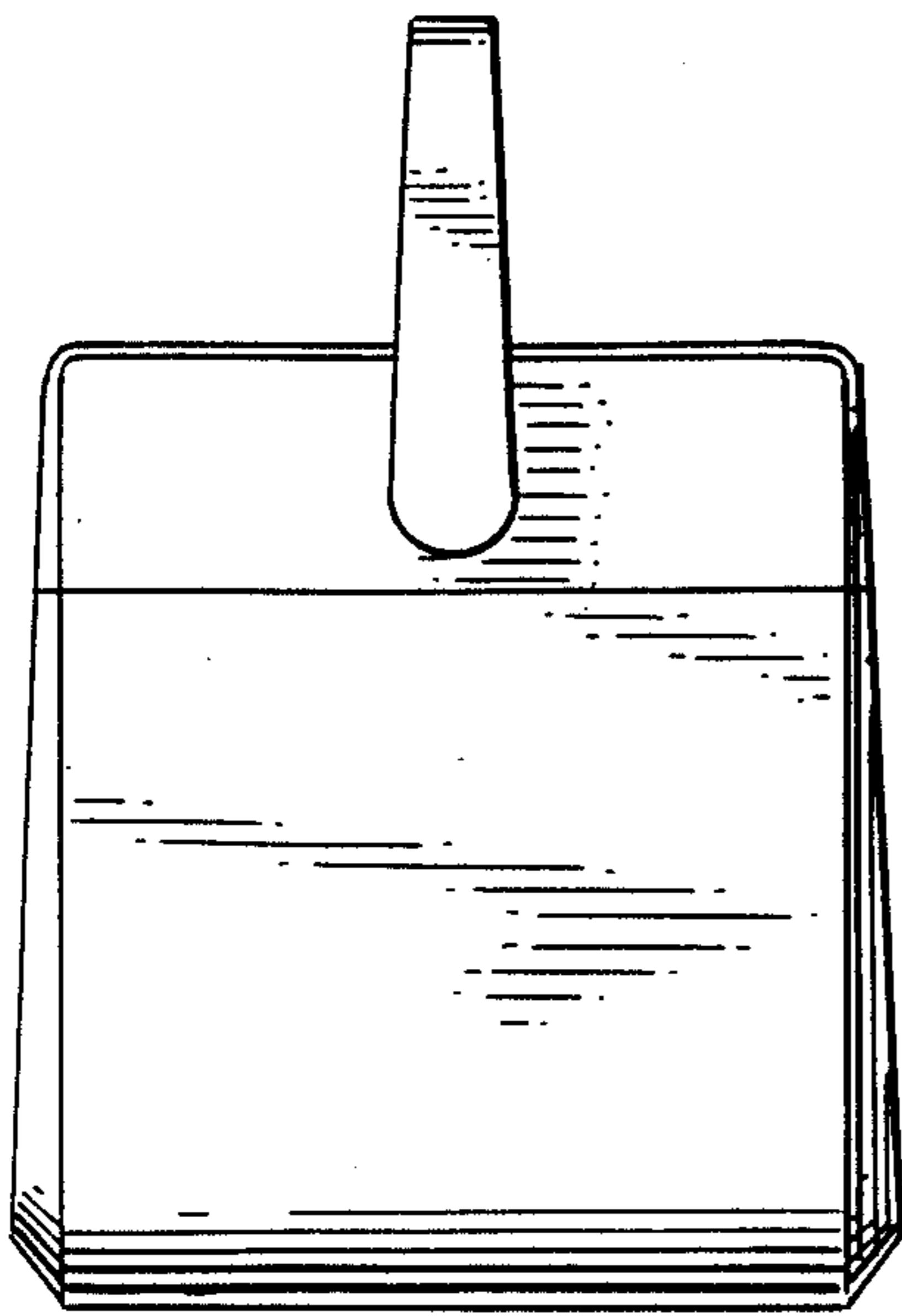

FIG. 3

FIG. 5

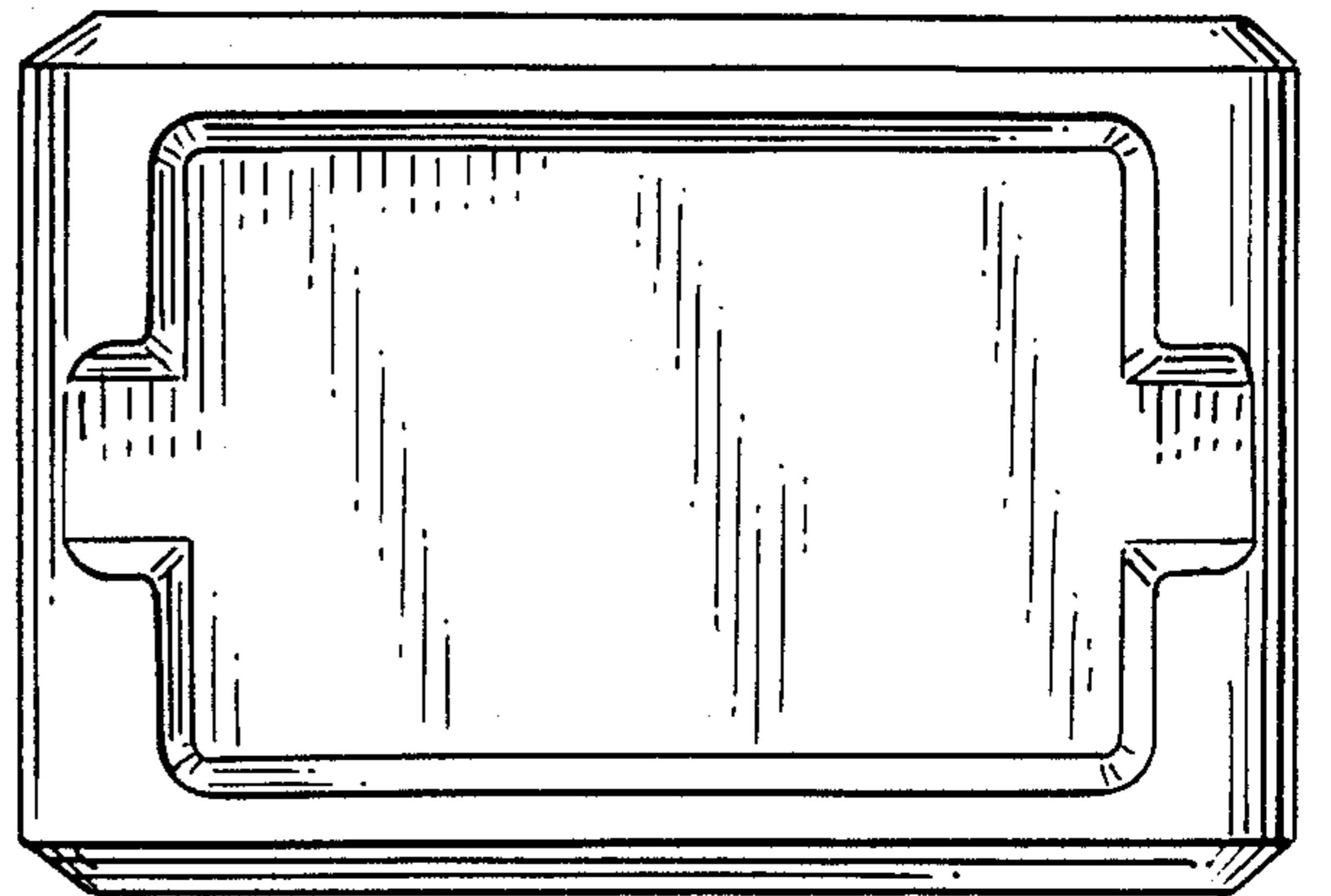
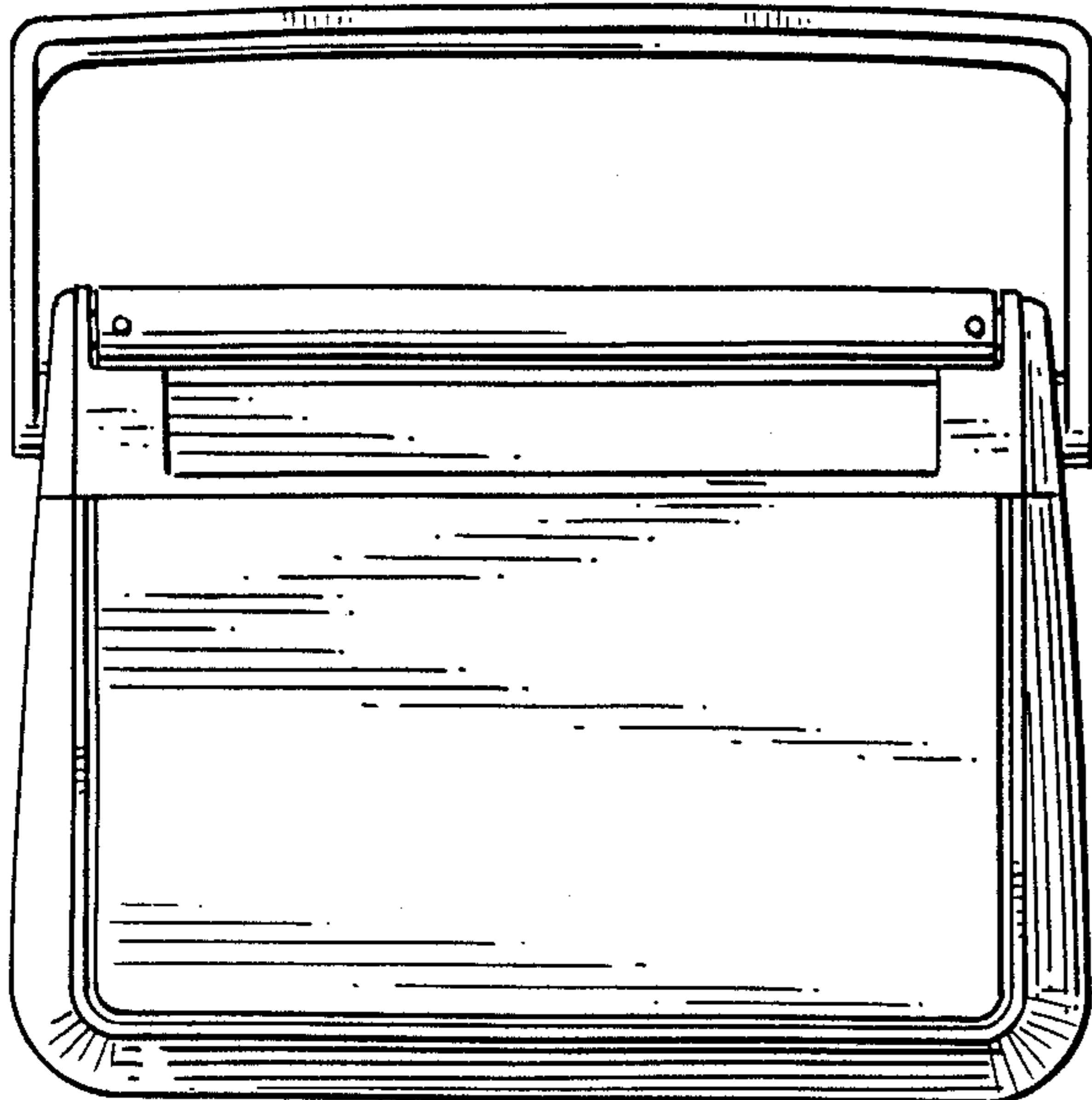

FIG. 7