

[54] VACUUM CLEANER

[75] Inventors: John F. Sovis, Twinsburg; James J. Kopco, Richmond Heights; Jeffrey M. Kalman, Cleveland Heights; Craig M. Saunders, Sagamore Hills, all of Ohio

[73] Assignee: Royal Appliance Manufacturing Co., Cleveland, Ohio

[\*\*] Term: 14 Years

[21] Appl. No.: 99,510

[22] Filed: Sep. 22, 1987

[52] U.S. Cl. .... D32/22

[58] Field of Search ..... D32/21-22, D32/24, 32-34; 15/320-322, 328-329, 333, 338, 347, 349-351, 353, 412, 415 R, 415 A, 418-422

[56] References Cited

U.S. PATENT DOCUMENTS

- D. 212,830 11/1968 Rogers et al. .... D32/22
- D. 217,737 6/1970 Lagerstrom et al. .... D32/22

- D. 296,487 6/1988 Burns et al. .... D32/22
- 3,217,351 11/1965 Hayba ..... 15/333

Primary Examiner—A. Hugo Word  
Assistant Examiner—Ruth McInroy  
Attorney, Agent, or Firm—Fay, Sharpe, Beall, Fagan, Minnich & McKee

[57] CLAIM

The ornamental design for a vacuum cleaner, as shown and described.

DESCRIPTION

FIG. 1 is a front elevational view of a vacuum cleaner showing our new design;  
FIG. 2 is a side elevational view thereof;  
FIG. 3 is a rear elevational view thereof;  
FIG. 4 is a side elevational view of the opposite side of FIG. 2;  
FIG. 5 is a top plan view thereof;  
FIG. 6 is a bottom plan view thereof; and  
FIG. 7 is a top, front and side perspective view thereof;  
The cross-hatch pattern shown on the vacuum cleaner bag in all views is understood to repeat throughout the indicated area.

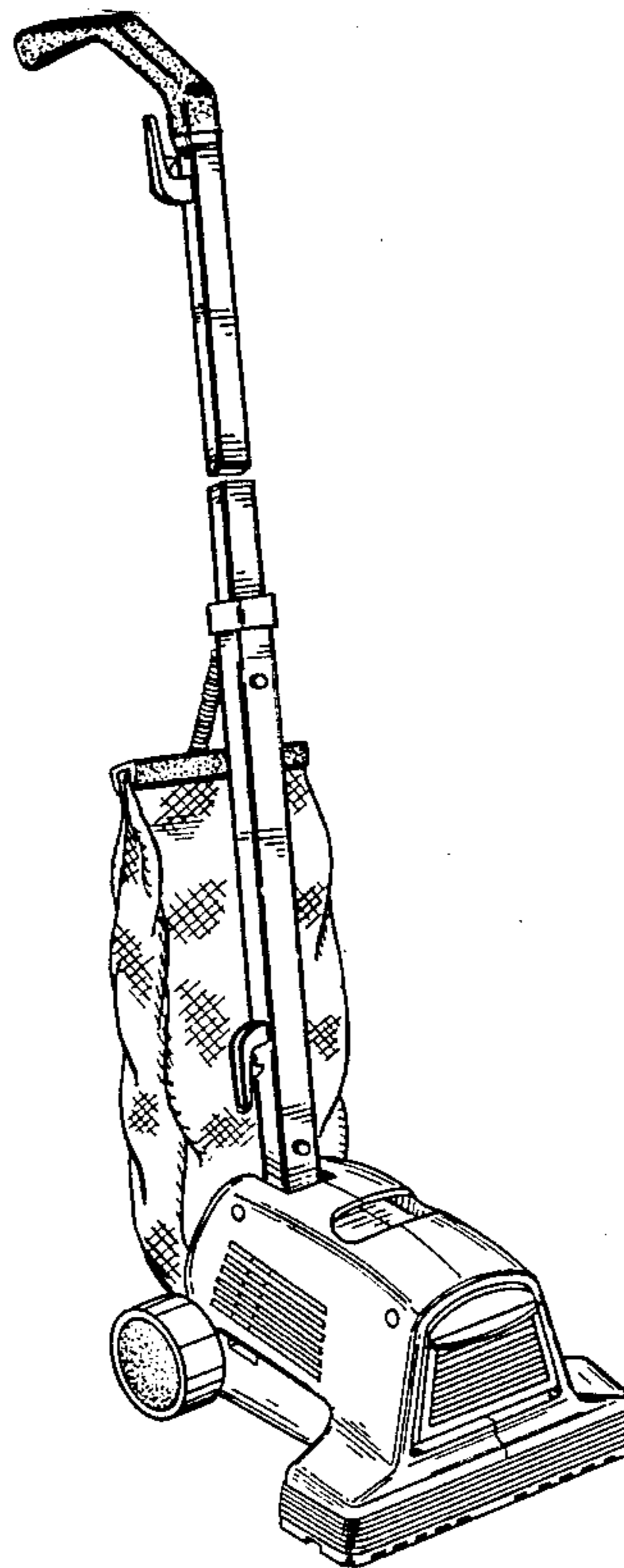

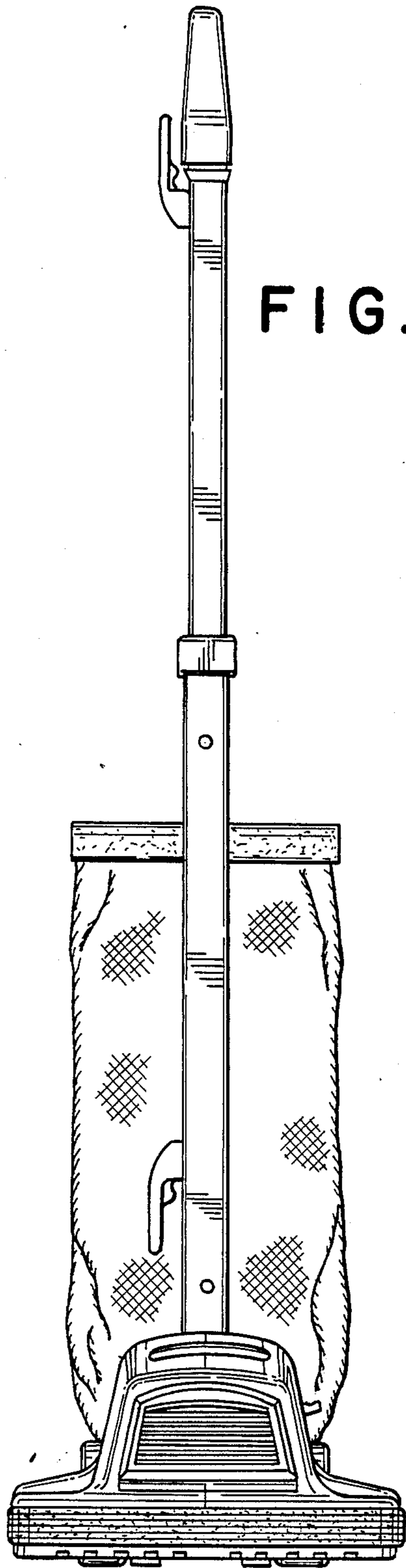

FIG. 1

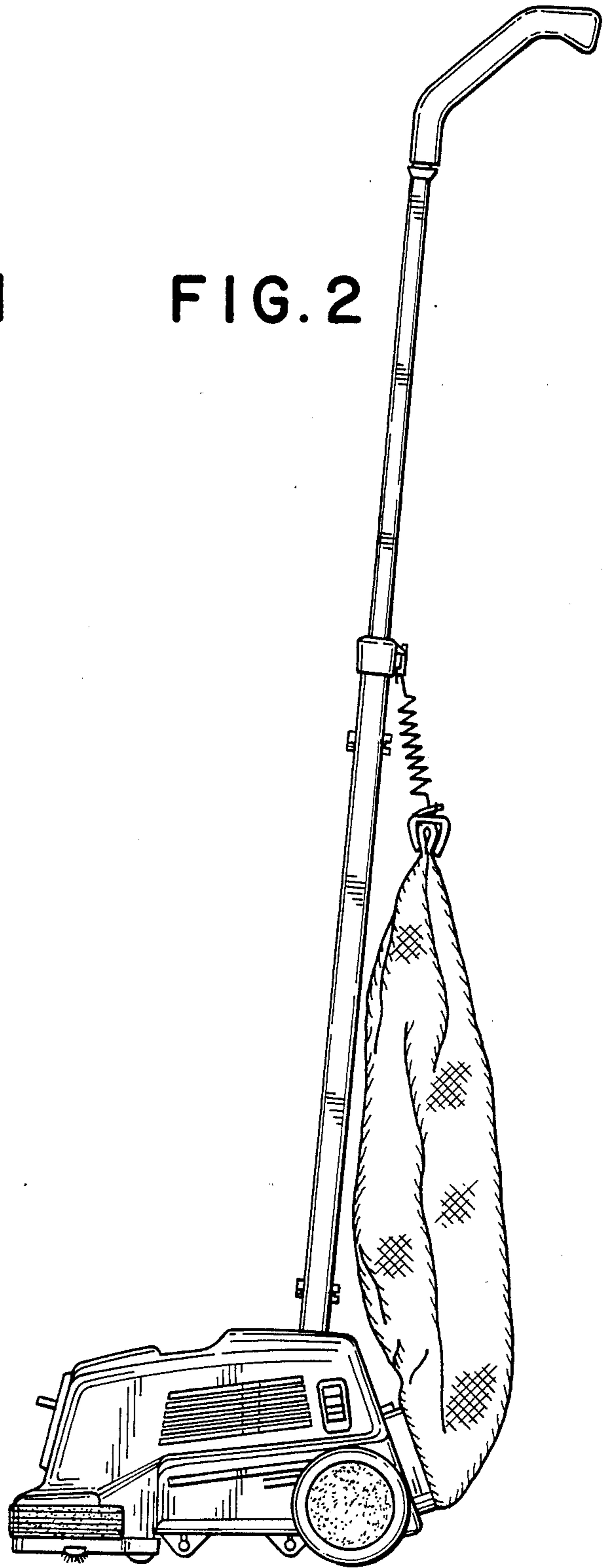

FIG. 2

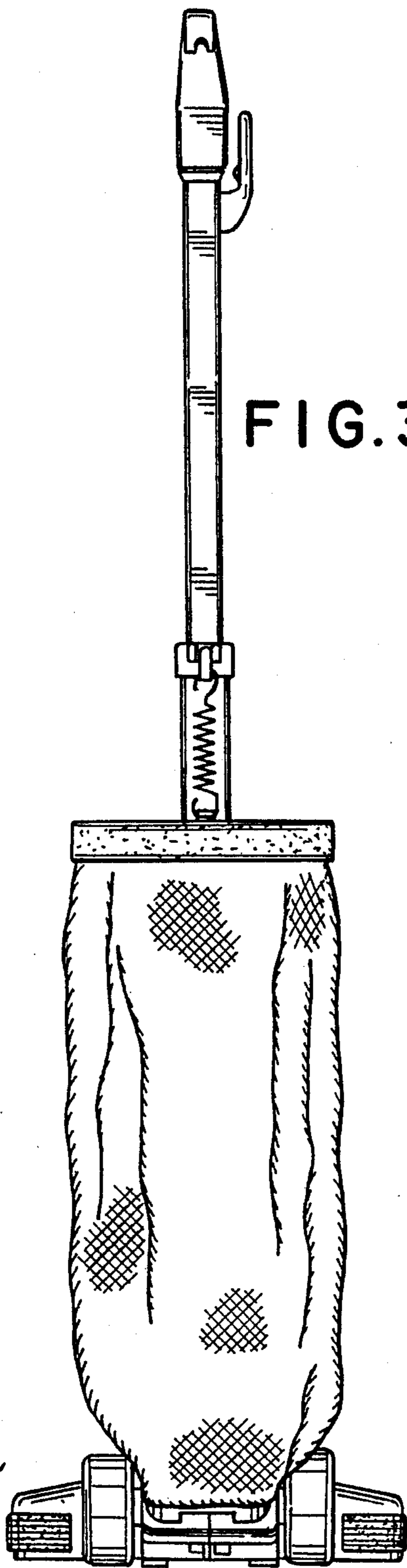

FIG. 3

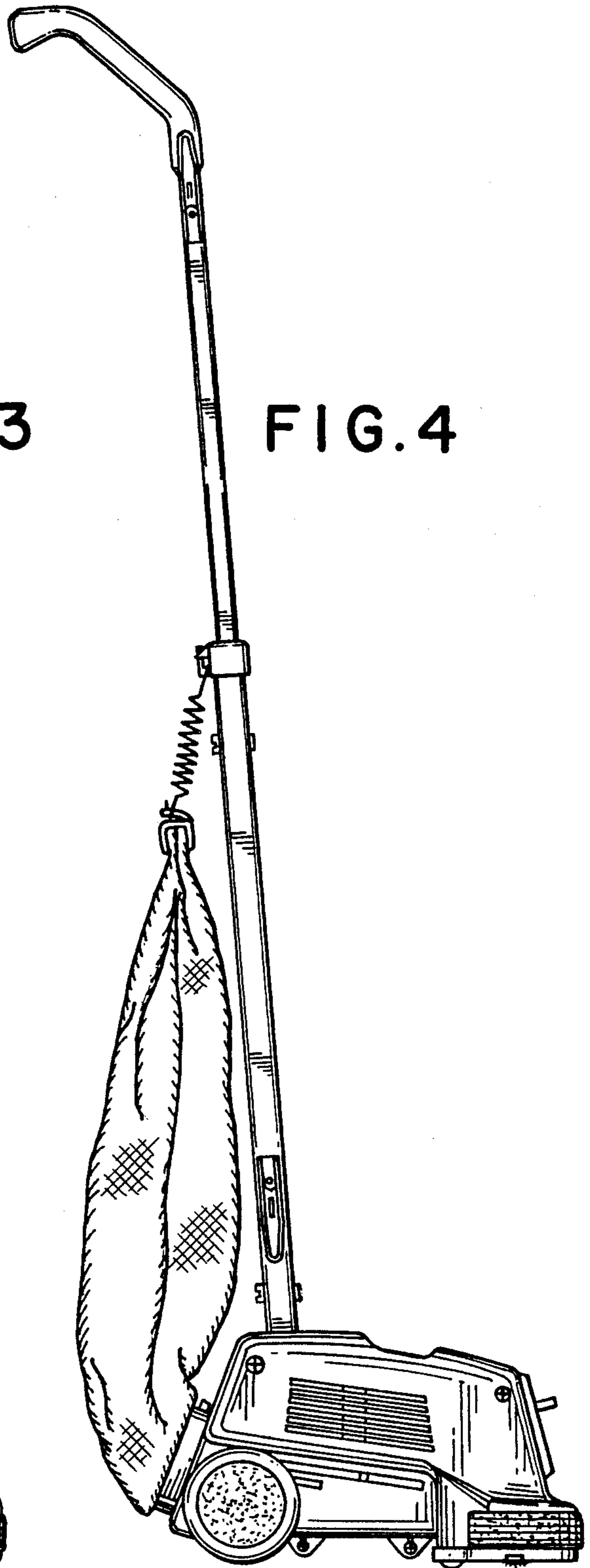

FIG. 4

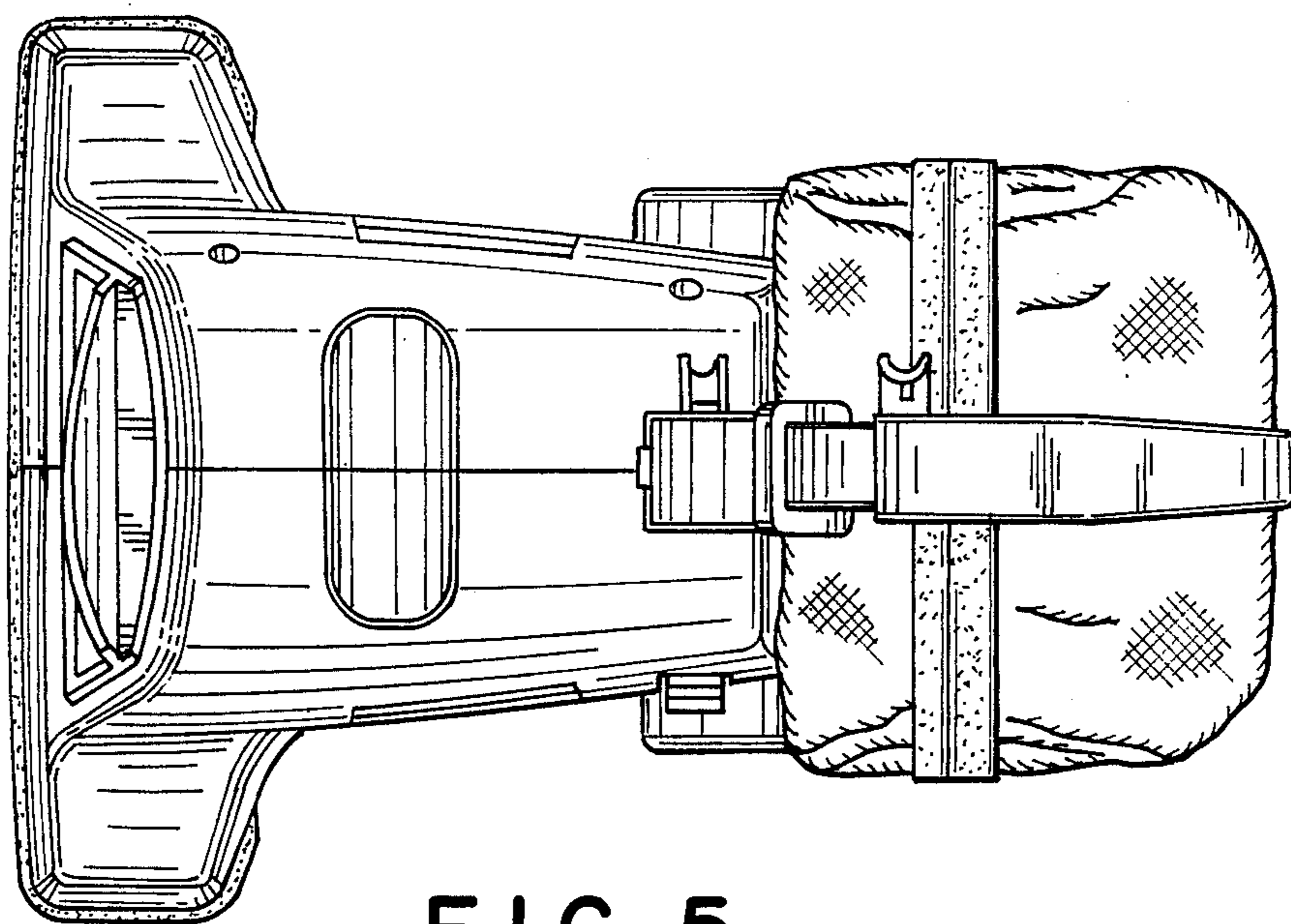

FIG. 5

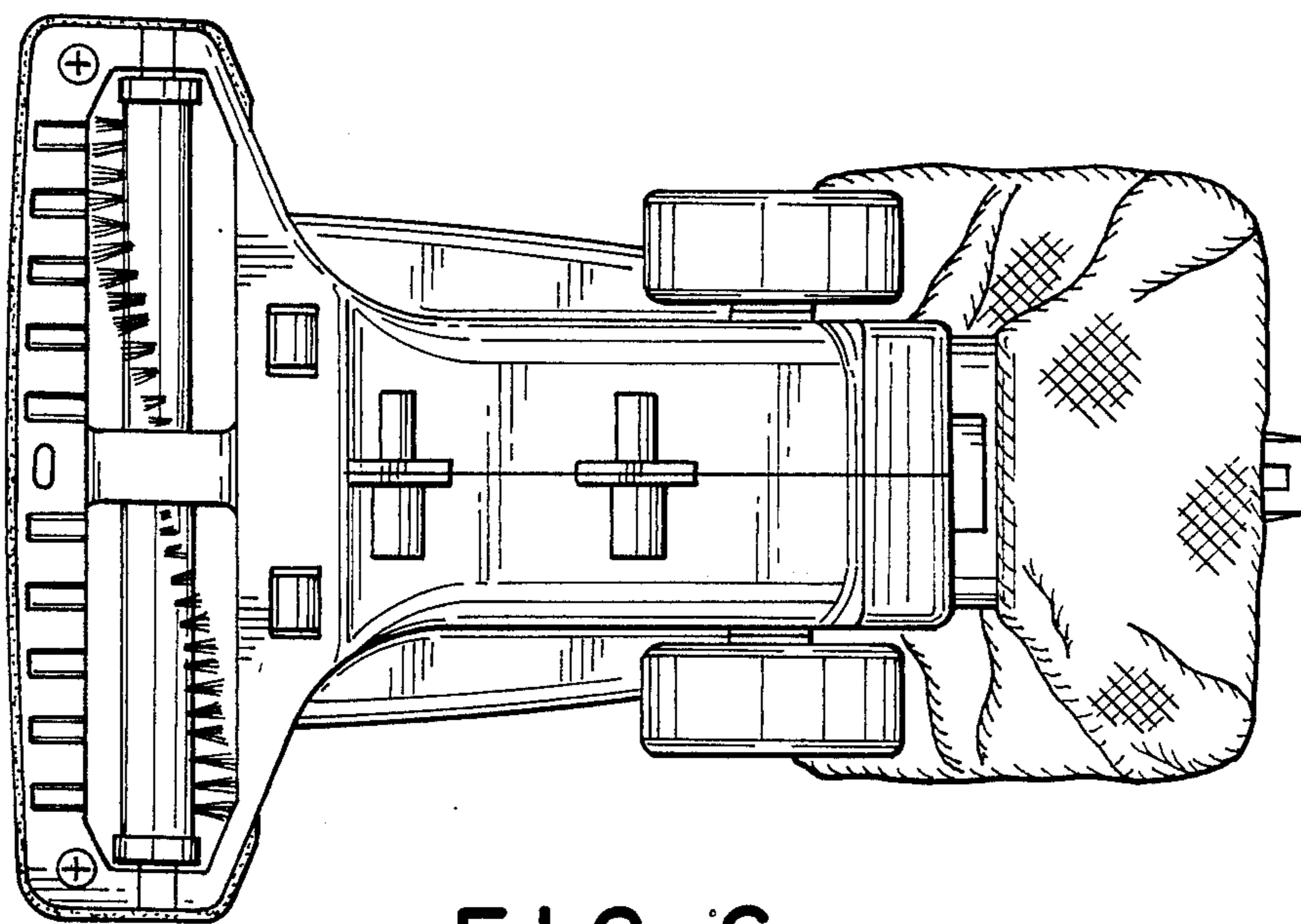

FIG. 6

FIG. 7

