

[54] **WOOD CRATE**
 [75] **Inventor: Roger Solomon, Watchung, N.J.**
 [73] **Assignee: Test-Rite Products Corp., Clifton, N.J.**
 [**] **Term: 14 Years**
 [21] **Appl. No.: 68,319**
 [22] **Filed: Jul. 1, 1987**
 [52] **U.S. Cl. D9/420; D9/432**
 [58] **Field of Search D9/414-433; D34/40; 217/12 R, 12 A, 36, 43 R, 66, 42, 47, 61, 56, 17, 11, 65; 206/386, 597, 600; 229/23 R, 23 C**

2,012,451	8/1935	Leigh	217/36
2,068,064	1/1937	Miller	217/36
2,117,194	10/1938	McElroy	217/36
2,351,092	6/1944	Baur	217/36
2,515,084	7/1950	Harris	217/43
2,738,058	3/1956	Hansen et al.	217/43
2,843,260	7/1958	Sommer	206/408
3,286,869	11/1966	Krein	217/12 R
3,414,152	12/1968	Overton, III	217/66
3,439,862	3/1969	Overton	229/23 R

OTHER PUBLICATIONS

Modern Packaging Encyc 1970 p. 365.
 U.S. Trademark Application Drawing Ser. No. 520,719
 Filed Feb. 14, 1985.

Primary Examiner—Bernard Ansher
Assistant Examiner—Prabhakar Deshmukh
Attorney, Agent, or Firm—Natter & Natter

[56] **References Cited**
U.S. PATENT DOCUMENTS

D. 286,619	11/1986	Slucker	D9/432
515,226	2/1894	Howell	217/43 R
756,260	4/1904	Miller	217/42
906,231	12/1908	Hubbard	217/47
928,689	12/1909	Orzali	217/12 R
999,020	7/1911	Erhart	116/172
1,111,809	9/1914	Shellenberger	217/12 A
1,222,416	4/1917	Krbavac	217/12 R
1,222,543	4/1917	Dunn	217/43 R
1,470,063	10/1923	Davis	217/66
1,616,618	2/1927	Gaylord	217/43 R
1,636,607	7/1927	Horton	217/36
1,797,194	3/1931	Simmons	403/370

[57] **CLAIM**

The ornamental design for a wood crate, as shown.

DESCRIPTION

FIG. 1 is a front elevation of a wood crate showing my new design;
 FIG. 2 is a rear side elevation thereof;
 FIG. 3 is a right side elevation thereof;
 FIG. 4 is a left side elevation thereof;
 FIG. 5 is a top plan view thereof;
 FIG. 6 is a bottom plan view thereof; and
 FIG. 7 is a perspective view thereof; in open position.

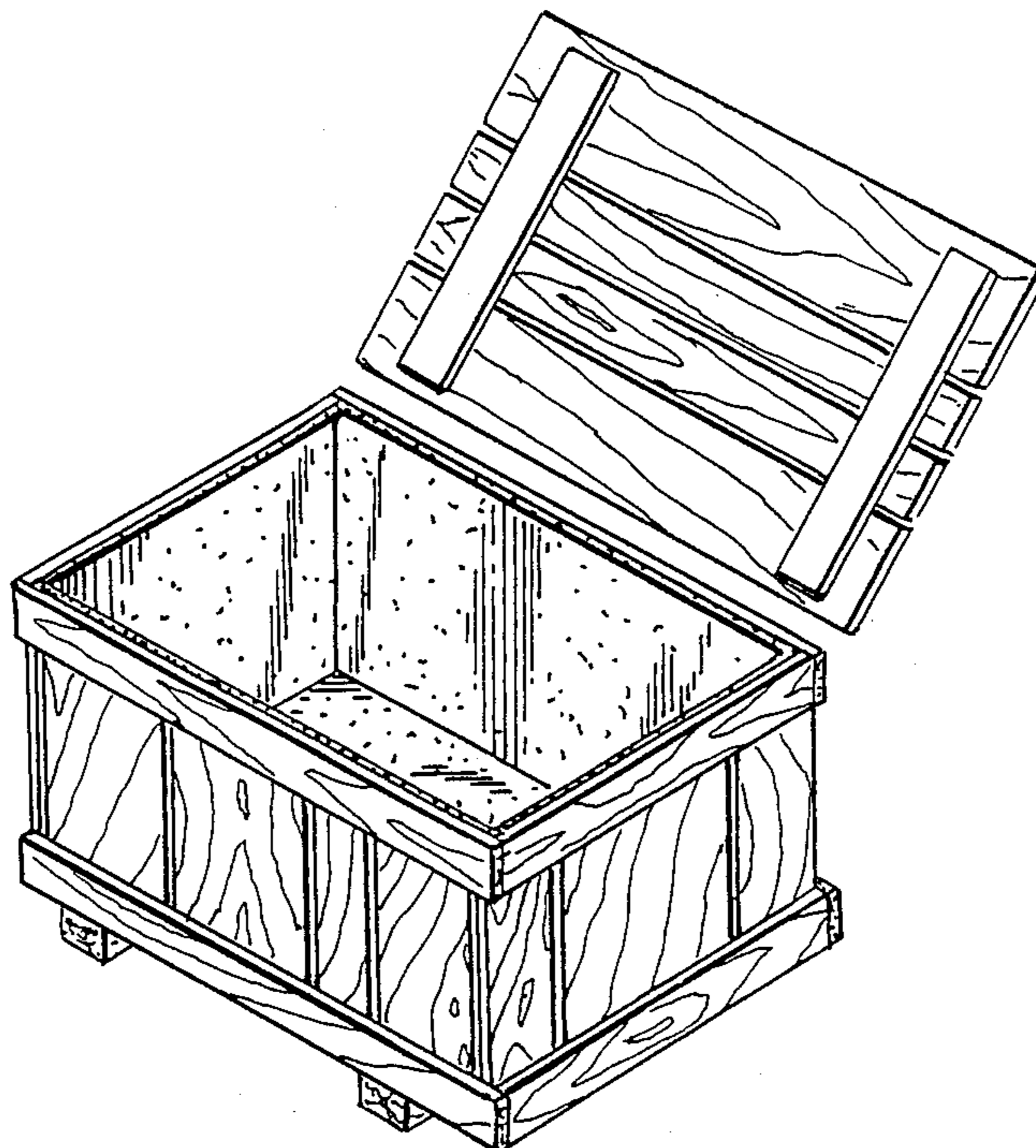

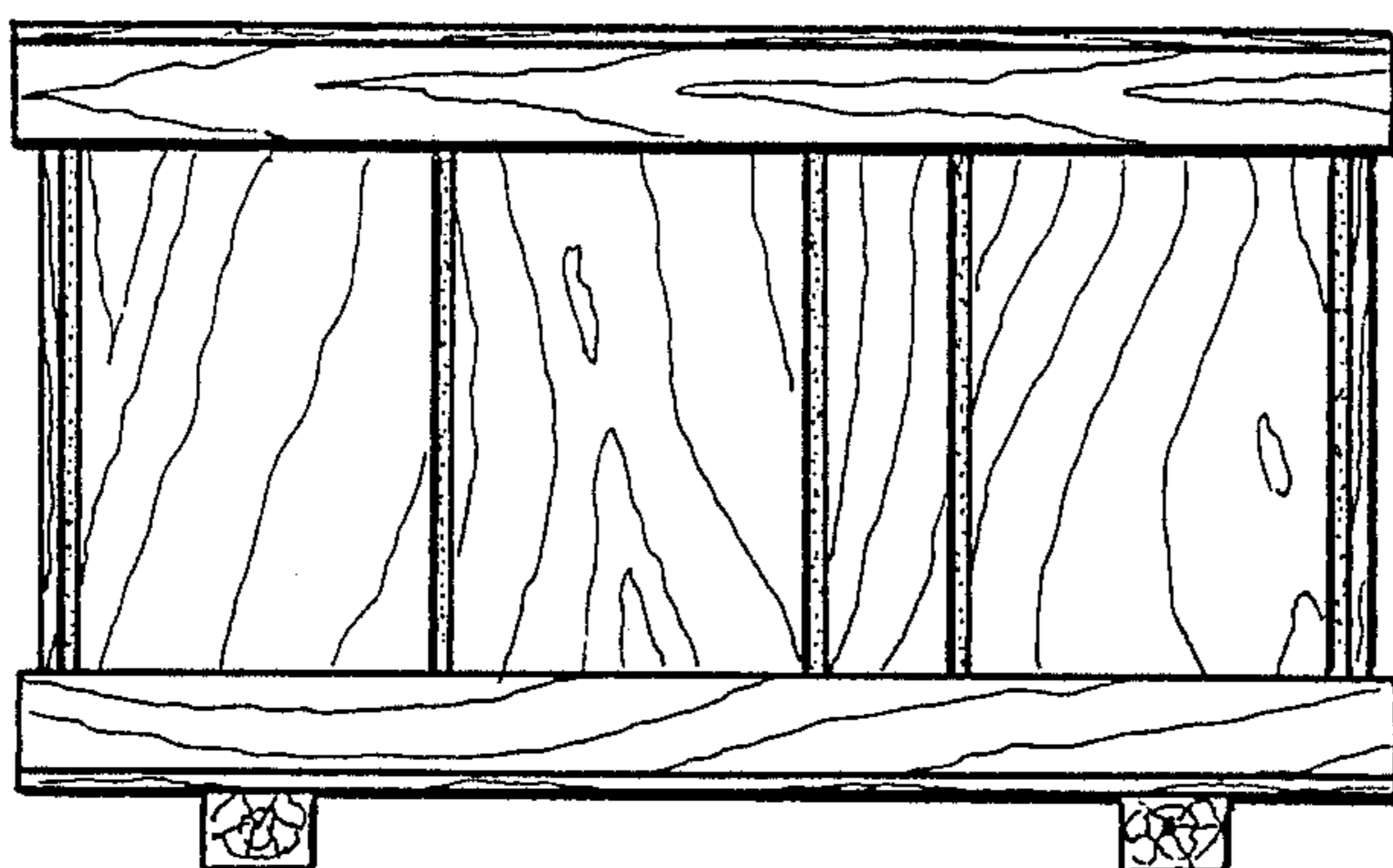

FIG. 1

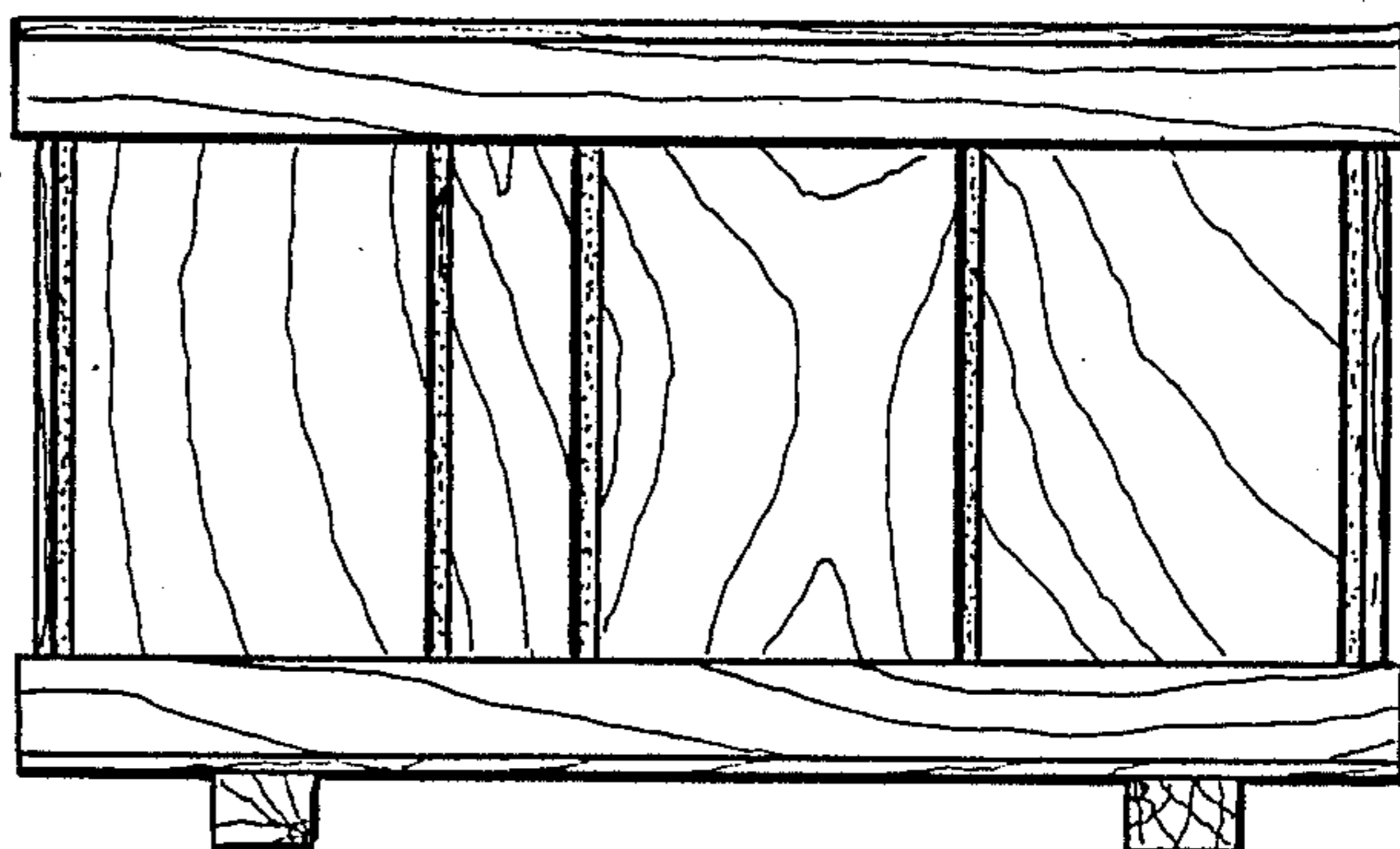

FIG. 2

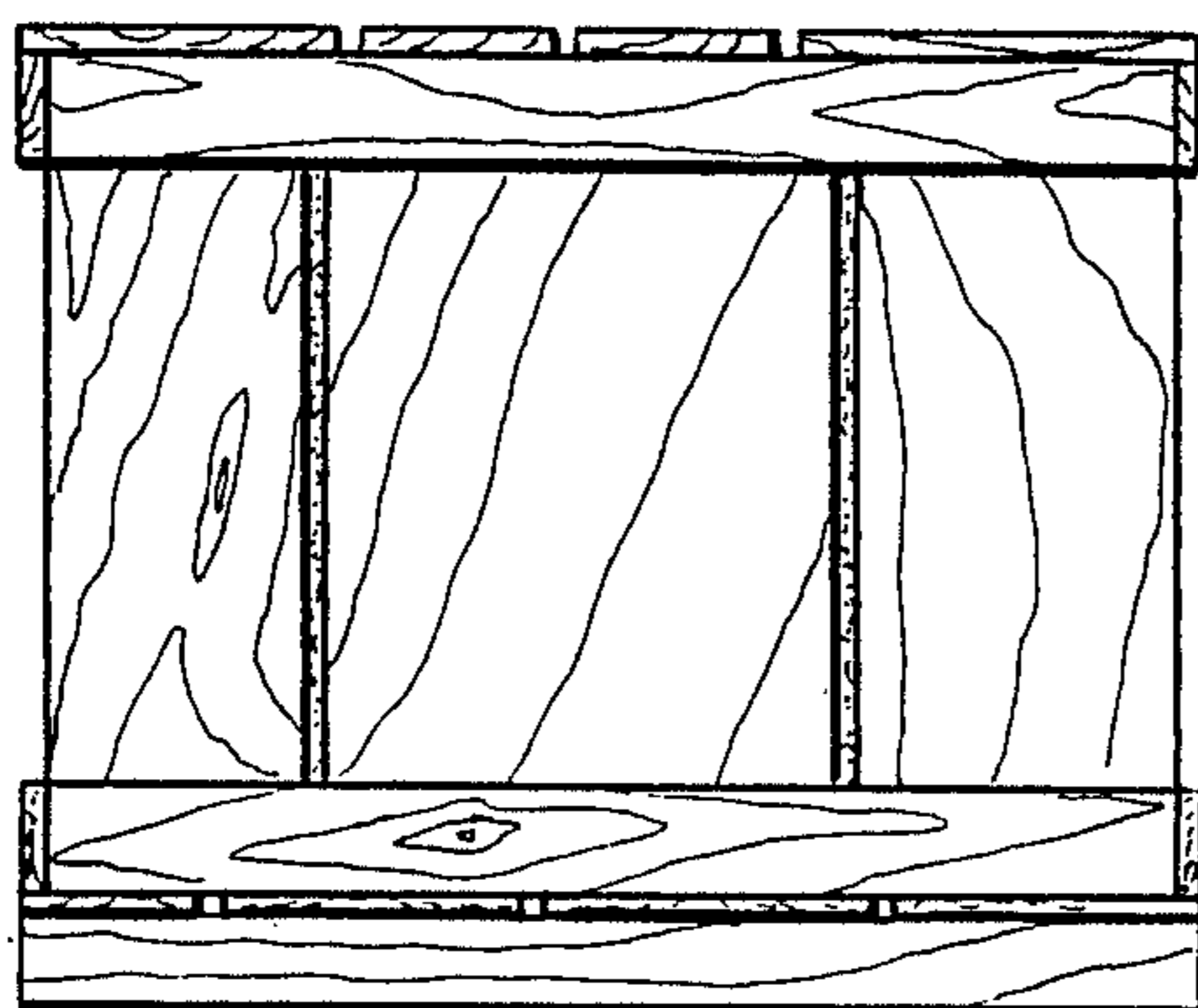

FIG. 3

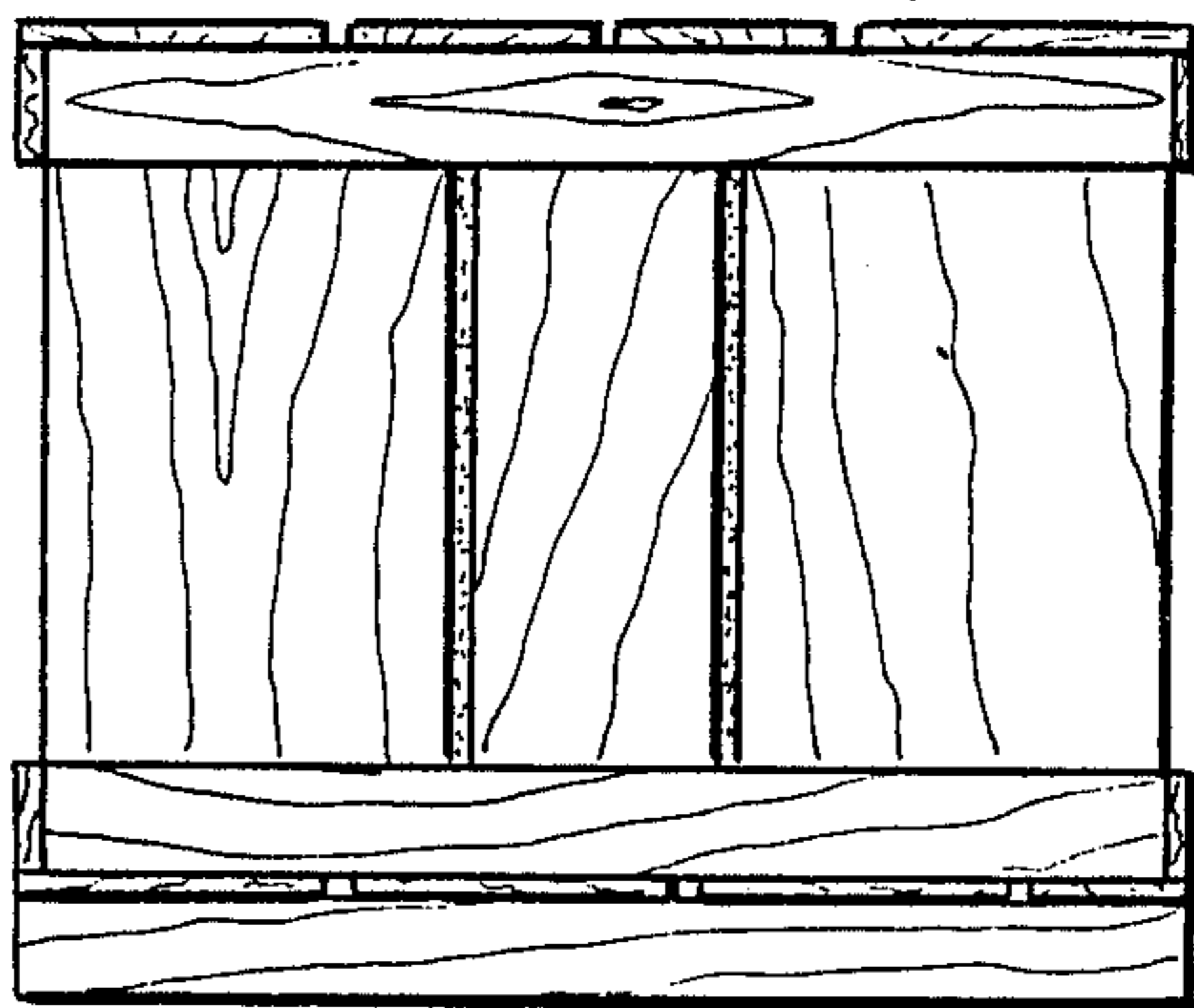

FIG. 4

FIG. 5

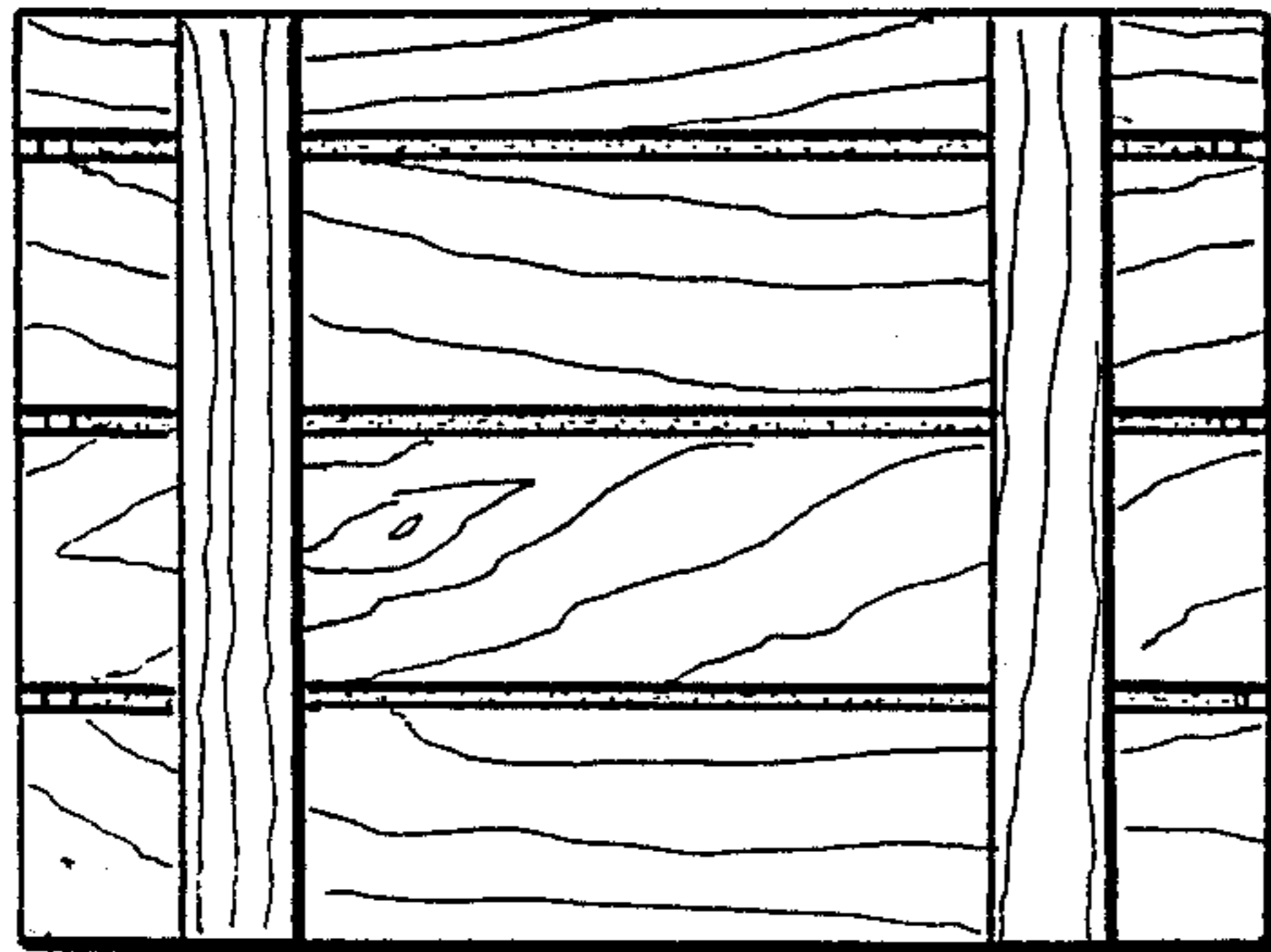
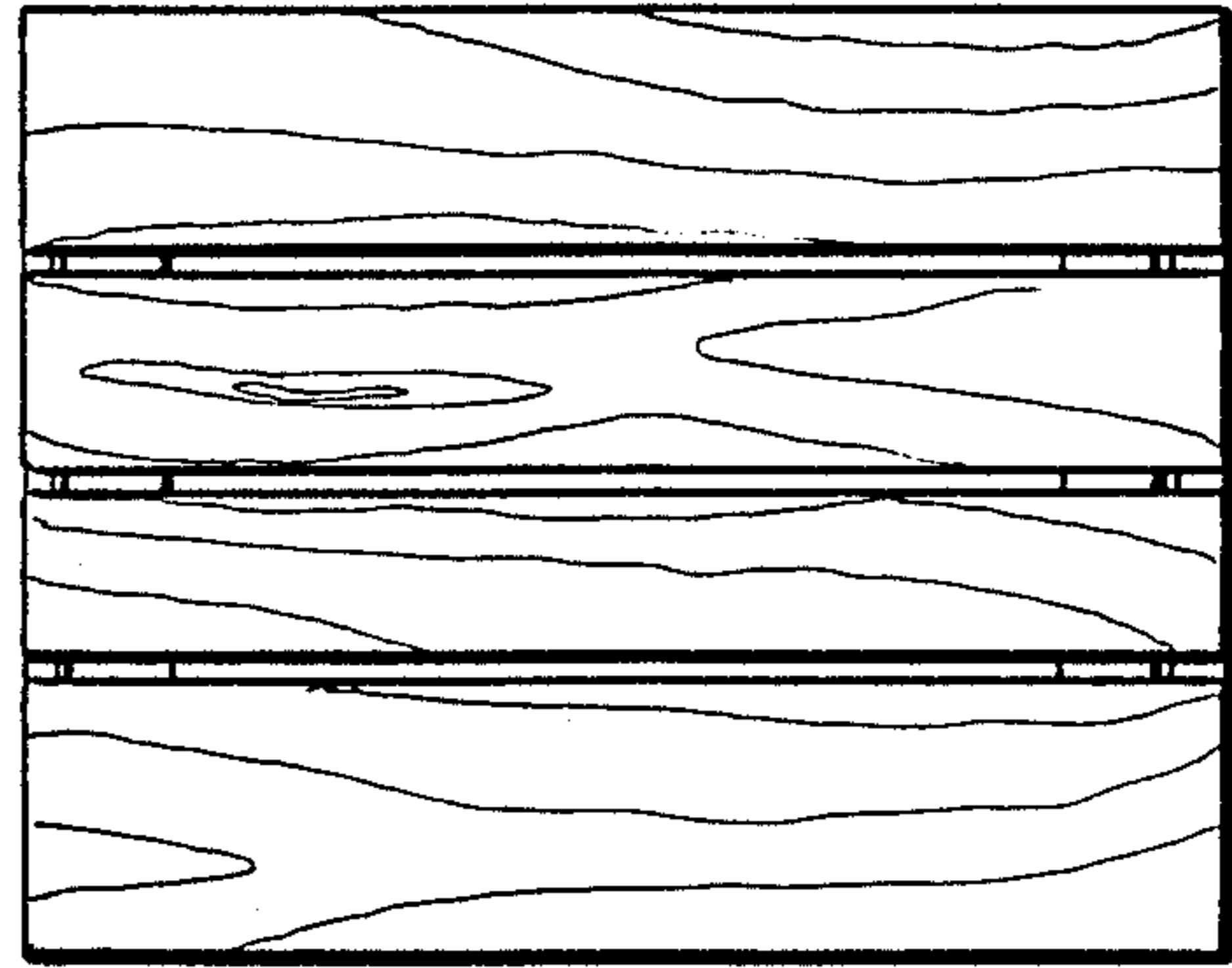

FIG. 6

FIG. 7

