

[54] SQUEEZE RESISTANT CARTON HOLDER

[76] Inventor: Henry J. Kelston, 23 Clinton Ave., Nyack, N.Y. 10960

[\*\*] Term: 14 Years

[21] Appl. No.: 163,046

[22] Filed: Mar. 2, 1988

[52] U.S. Cl. .... D7/602

[58] Field of Search ..... D7/70, 77; 220/85 H, 220/94 R; 248/311.2; 62/457.1, 457.3, 457.4, 457.8

[56] References Cited

U.S. PATENT DOCUMENTS

D. 149,866 6/1948 Fey ..... D7/70

Primary Examiner—Bernard Ansher  
Assistant Examiner—Terry A. Pfeffer  
Attorney, Agent, or Firm—Paul J. Sutton

[57] CLAIM

The ornamental design for a squeeze resistant carton holder, as shown and described.

DESCRIPTION

FIG. 1 is a top, front, left side perspective view of a squeeze resistant carton holder showing my new design; FIG. 2 is a top plan view thereof; FIG. 3 is a rear elevational view thereof; FIG. 4 is a left side elevational view thereof; FIG. 5 is a front elevational view thereof; FIG. 6 is a right side elevational view thereof; FIG. 7 is a bottom plan view thereof; and FIG. 8 is a perspective view thereof in an open position.

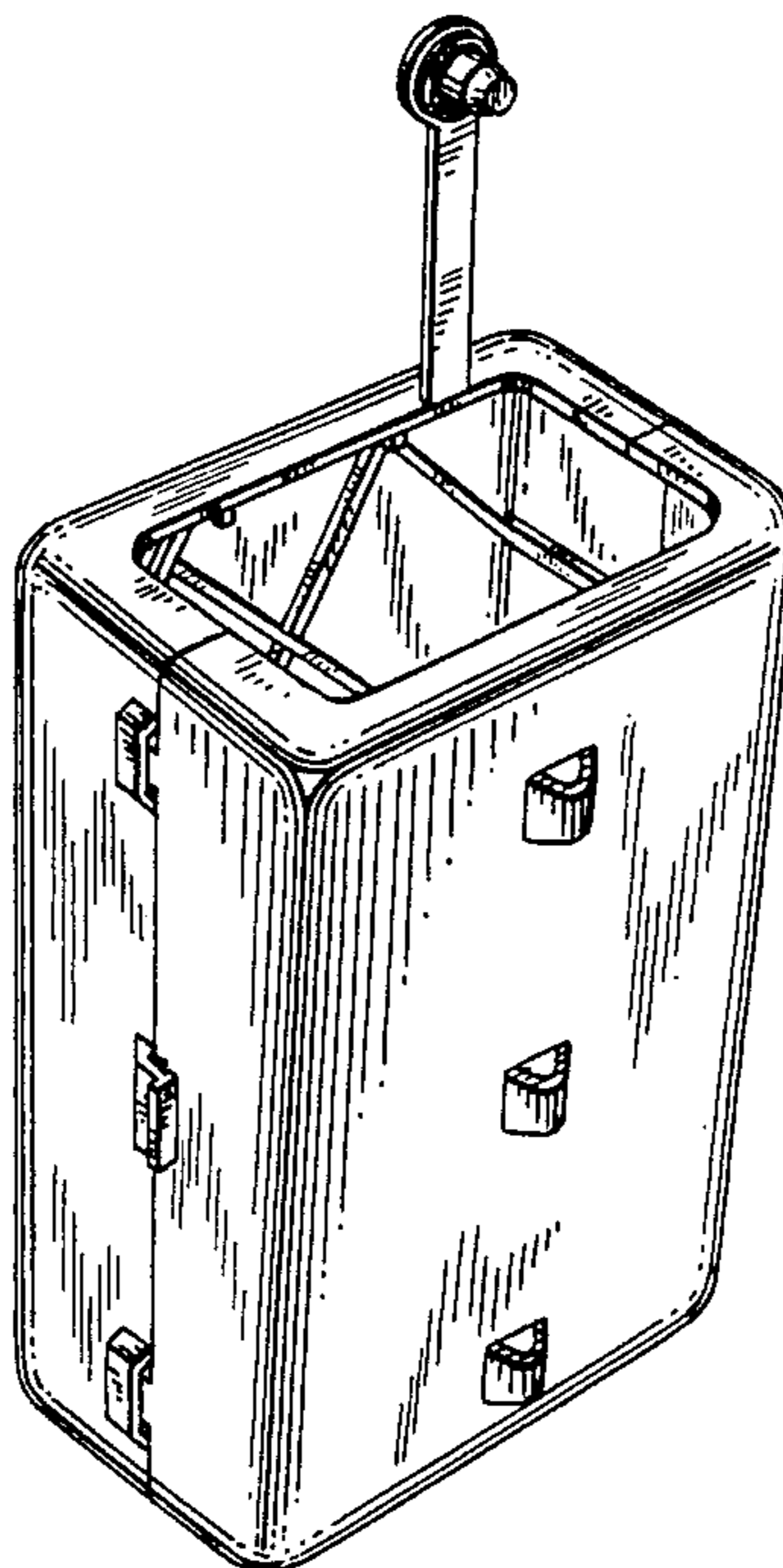

FIG. 1

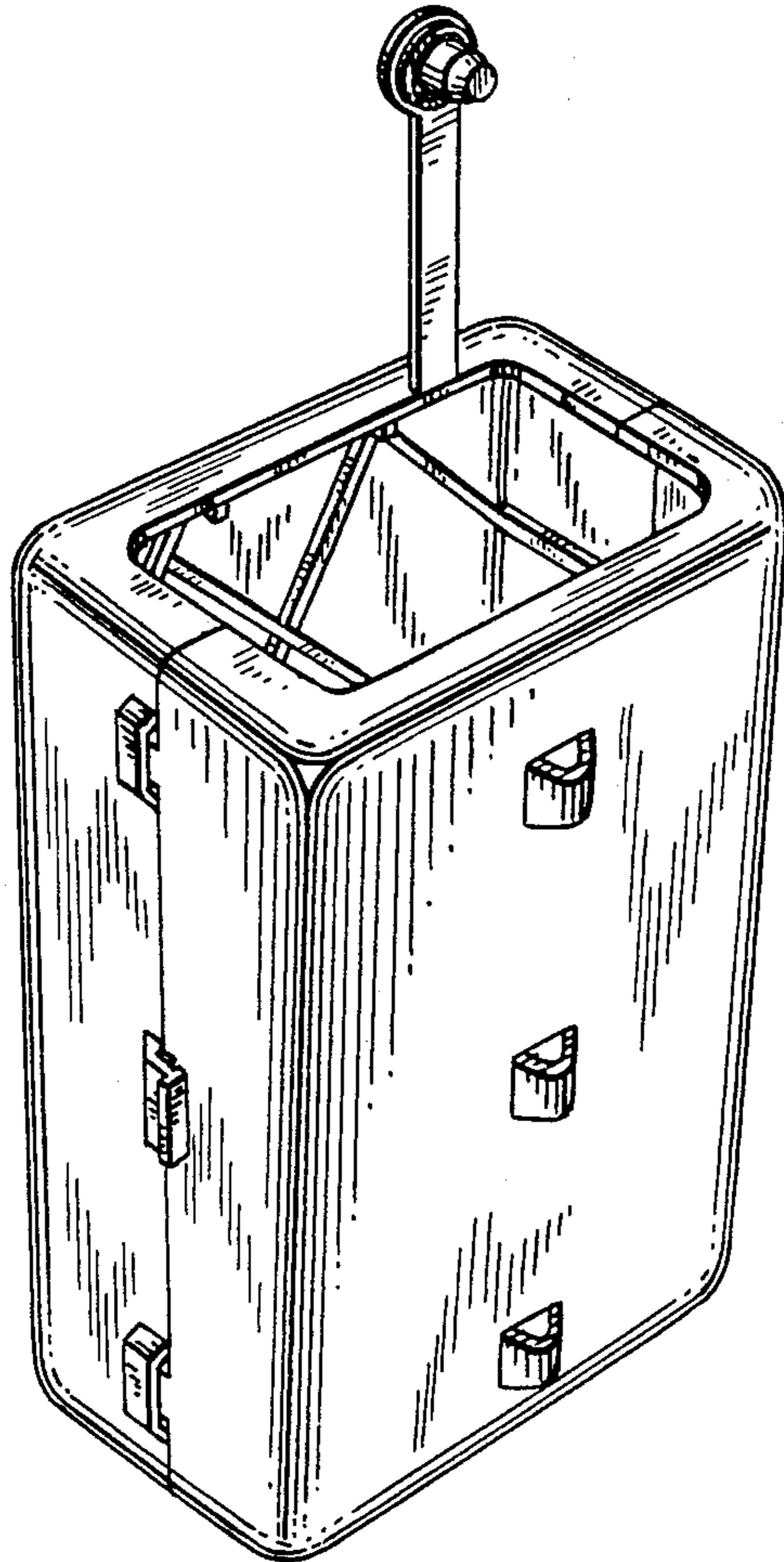

FIG. 2

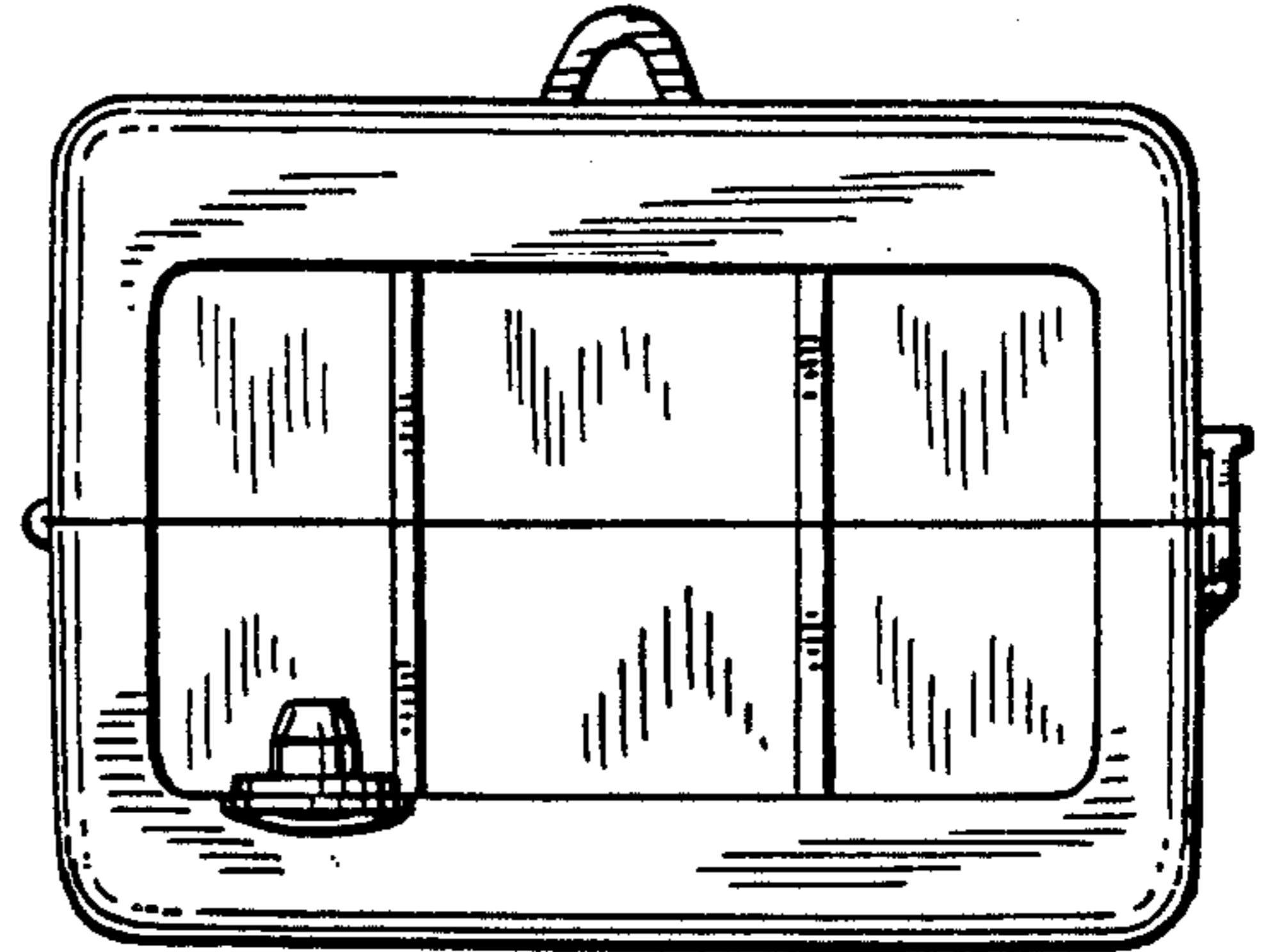
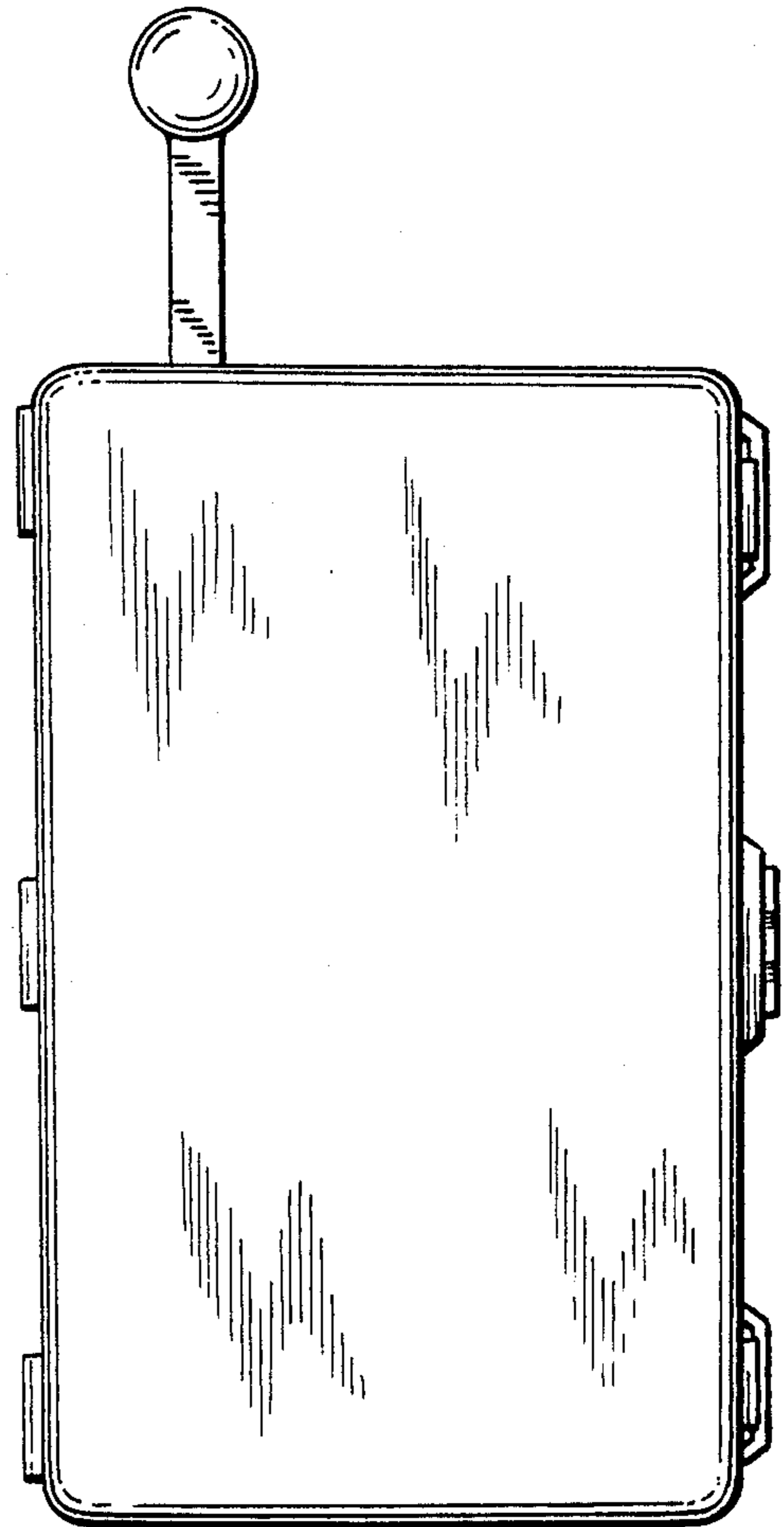

FIG. 3



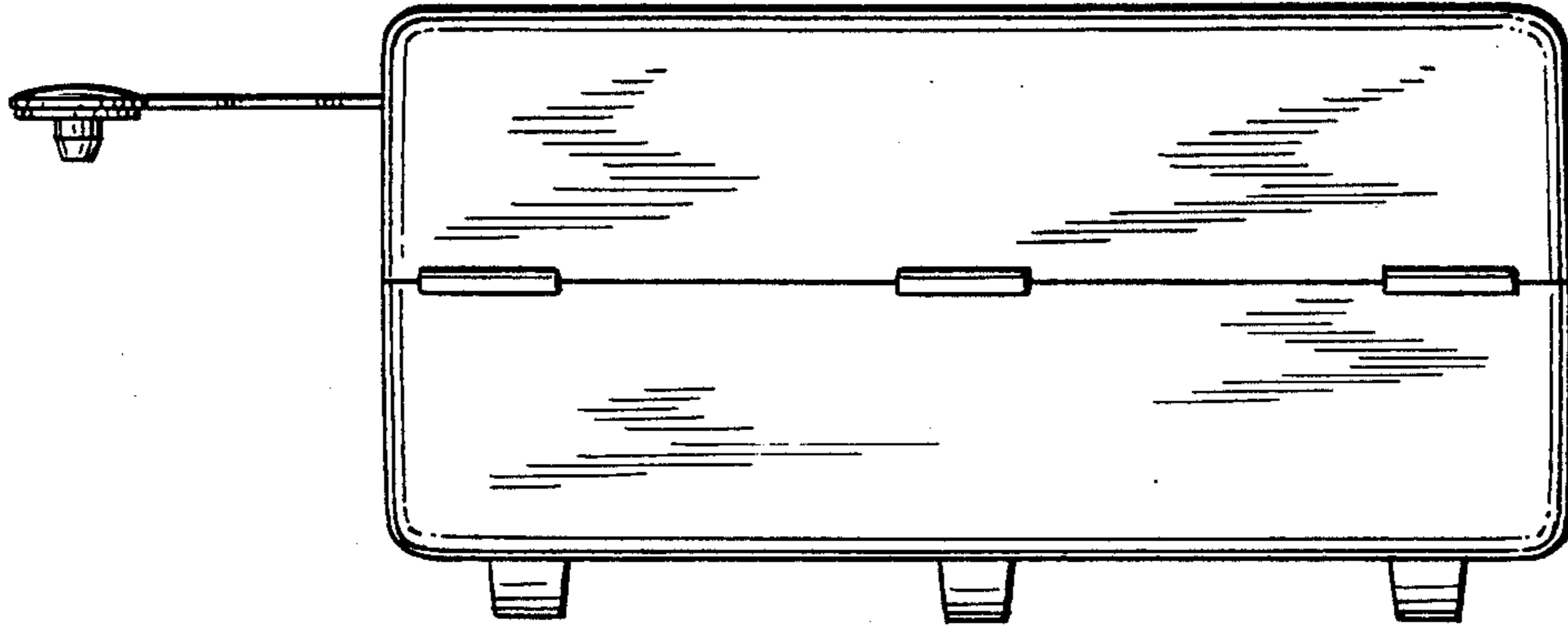

FIG. 6

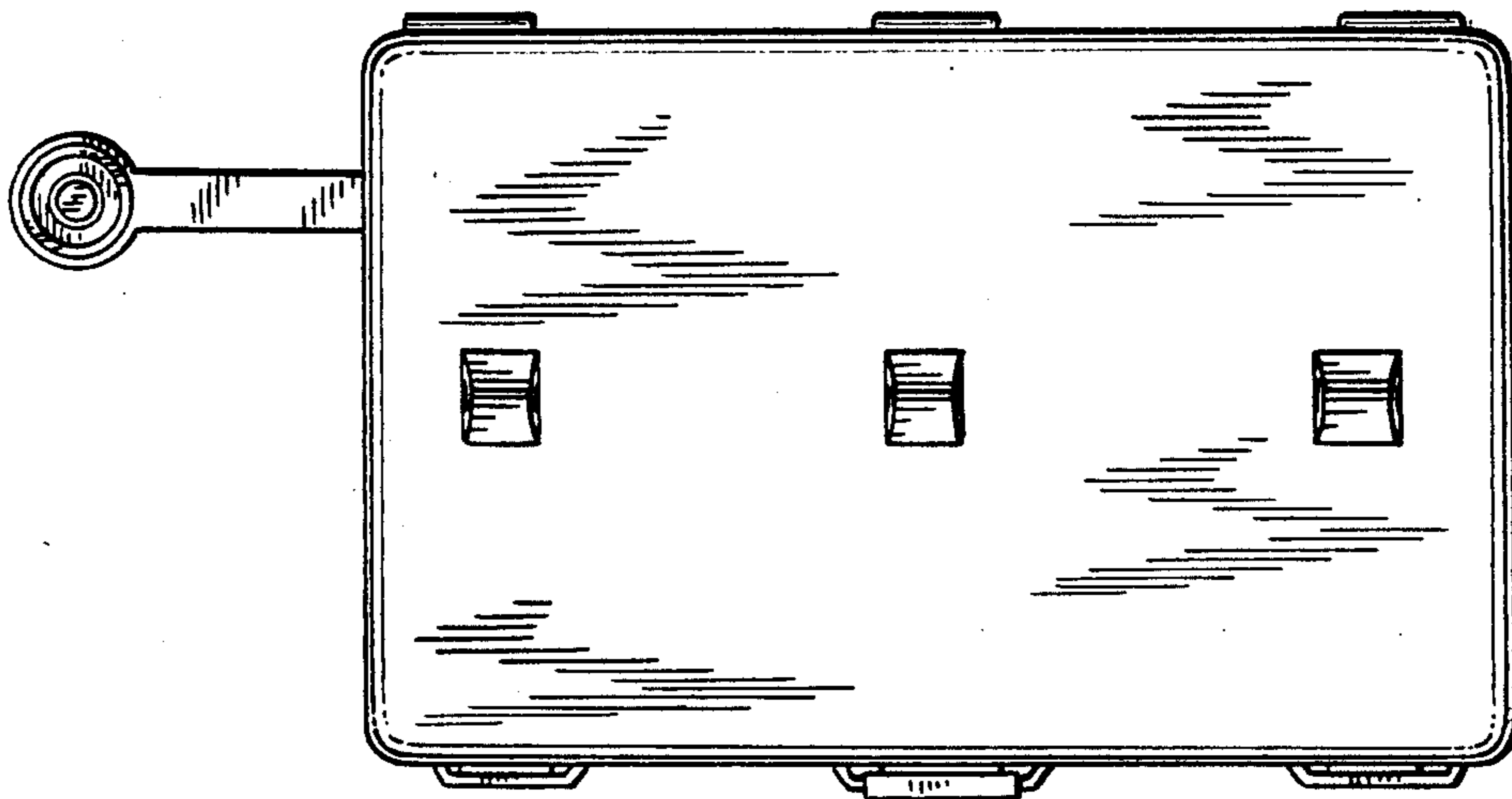

FIG. 5

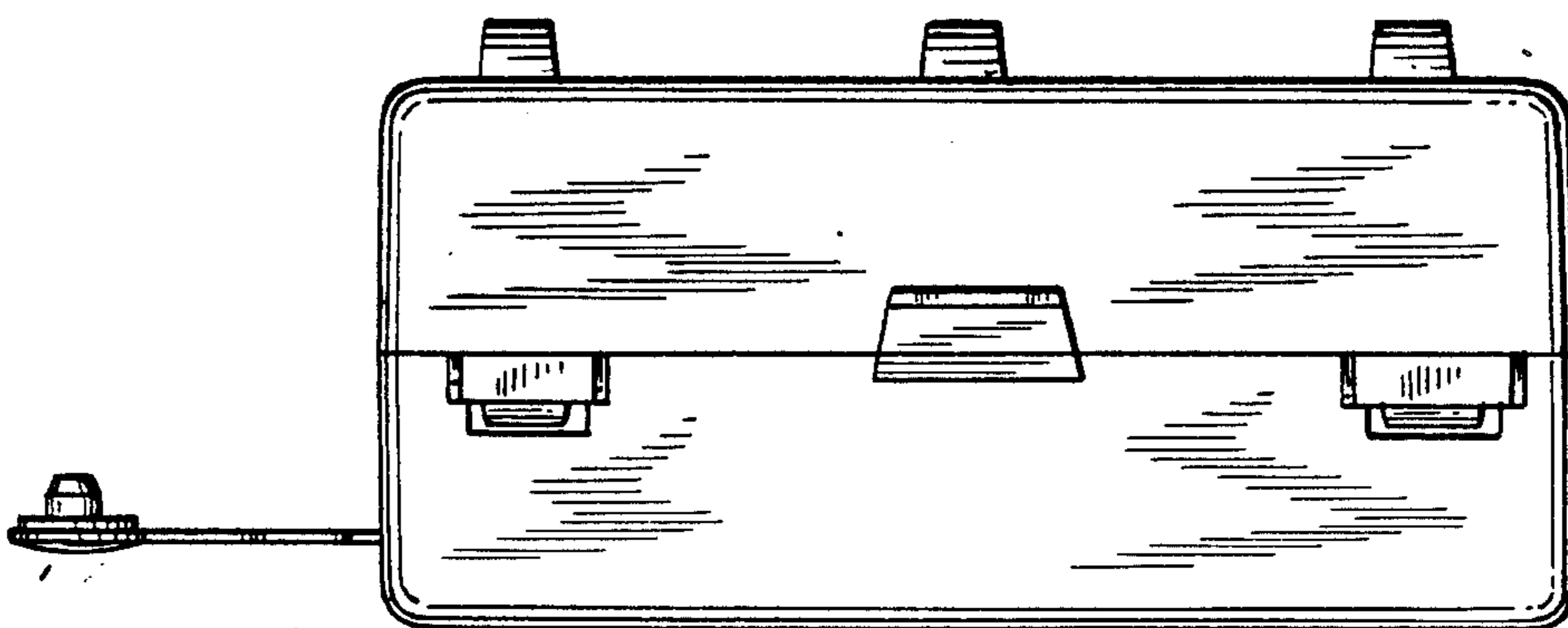
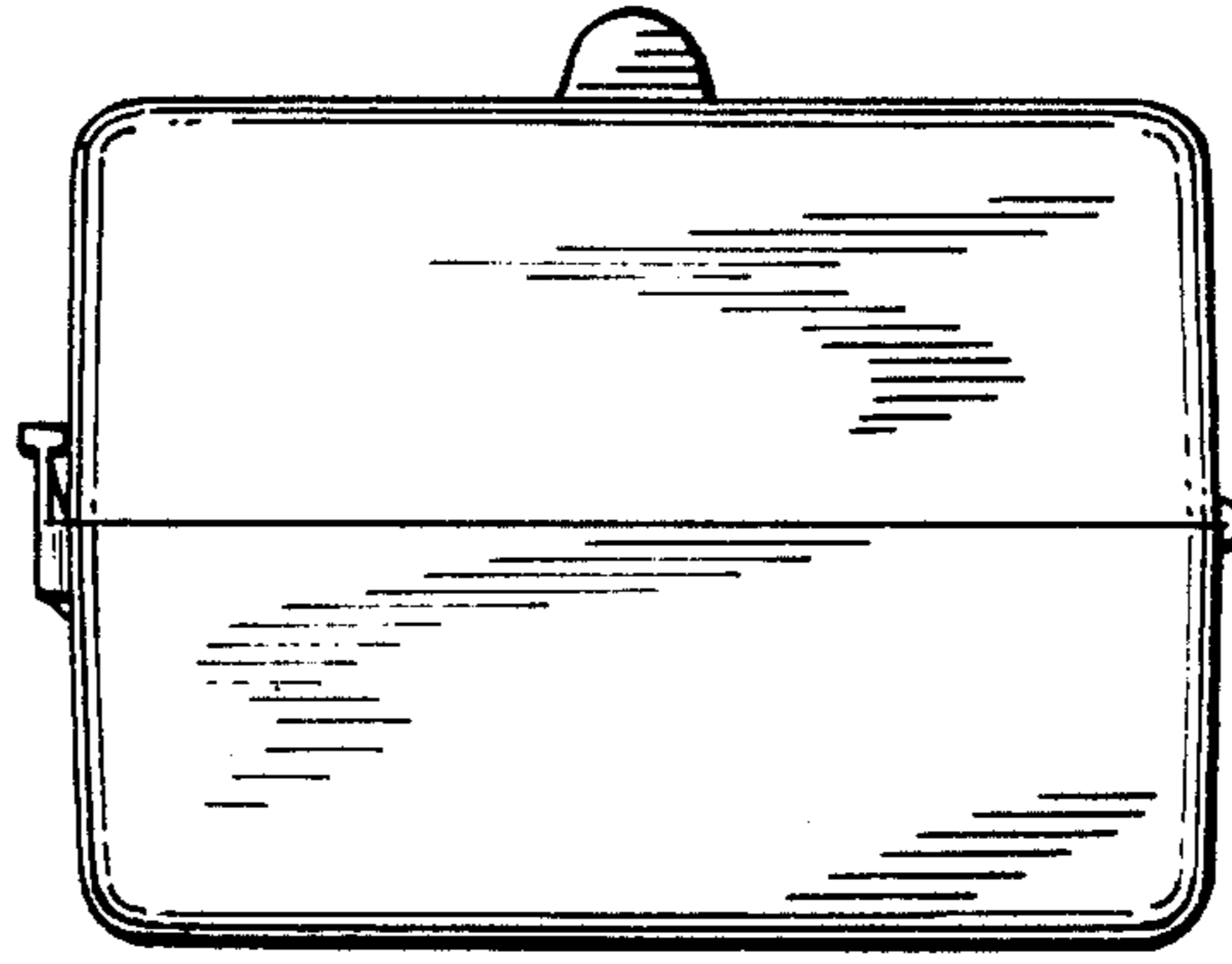

FIG. 4

*FIG. 7*



*FIG. 8*

