

[54] SHAKER BATH

3,985,511 10/1976 Betts 128/374 X

[76] Inventor: Dirk E. Vander Hout, 236 Birch Dr., Glenwood, Ill. 60425

Primary Examiner—A. Hugo Word
Assistant Examiner—Stella M. Reid
Attorney, Agent, or Firm—Emrich & Dithmar

[**] Term: 14 Years

[57] CLAIM

[21] Appl. No.: 78,187

The ornamental design for a shaker bath, as shown and described.

[22] Filed: Jul. 27, 1987

[52] U.S. Cl. D24/9

DESCRIPTION

[58] Field of Search D24/8, 9, 1.1; 422/104, 422/99; 366/108, 114, 115, 110, 111, 116, 124, 128, 144-147, 209, 220, 237, 239, 240; 126/374; 219/312, 328

FIG. 1 is a front elevational view of a shaker bath, showing my new design;
FIG. 2 is a rear elevational view thereof;
FIG. 3 is a side elevational view thereof;
FIG. 4 is a side elevational view thereof, opposite that shown in FIG. 3;
FIG. 5 is a top plan view thereof, the series of circles being partially shown for ease of illustration; and
FIG. 6 is a bottom plan view thereof, the cross-line pattern on the bottom of the design is partially shown for ease of illustration.

[56] References Cited

U.S. PATENT DOCUMENTS

D. 288,600	3/1987	Vander Hout et al.	D24/9
2,813,189	11/1957	Lawler	366/212 X
3,430,926	3/1969	Freedman et al.	366/212
3,601,372	8/1971	Harmes, III	D24/9 X

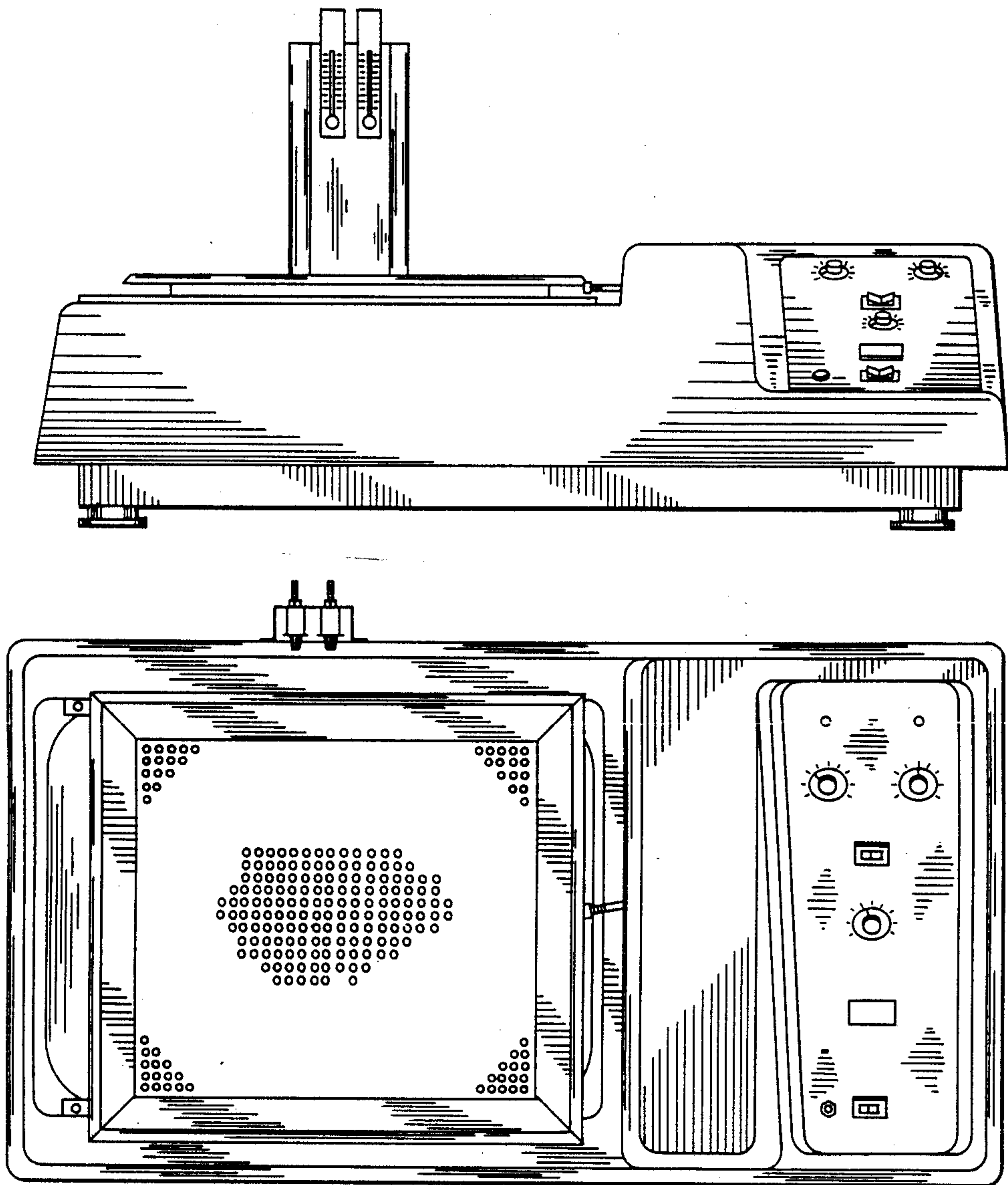

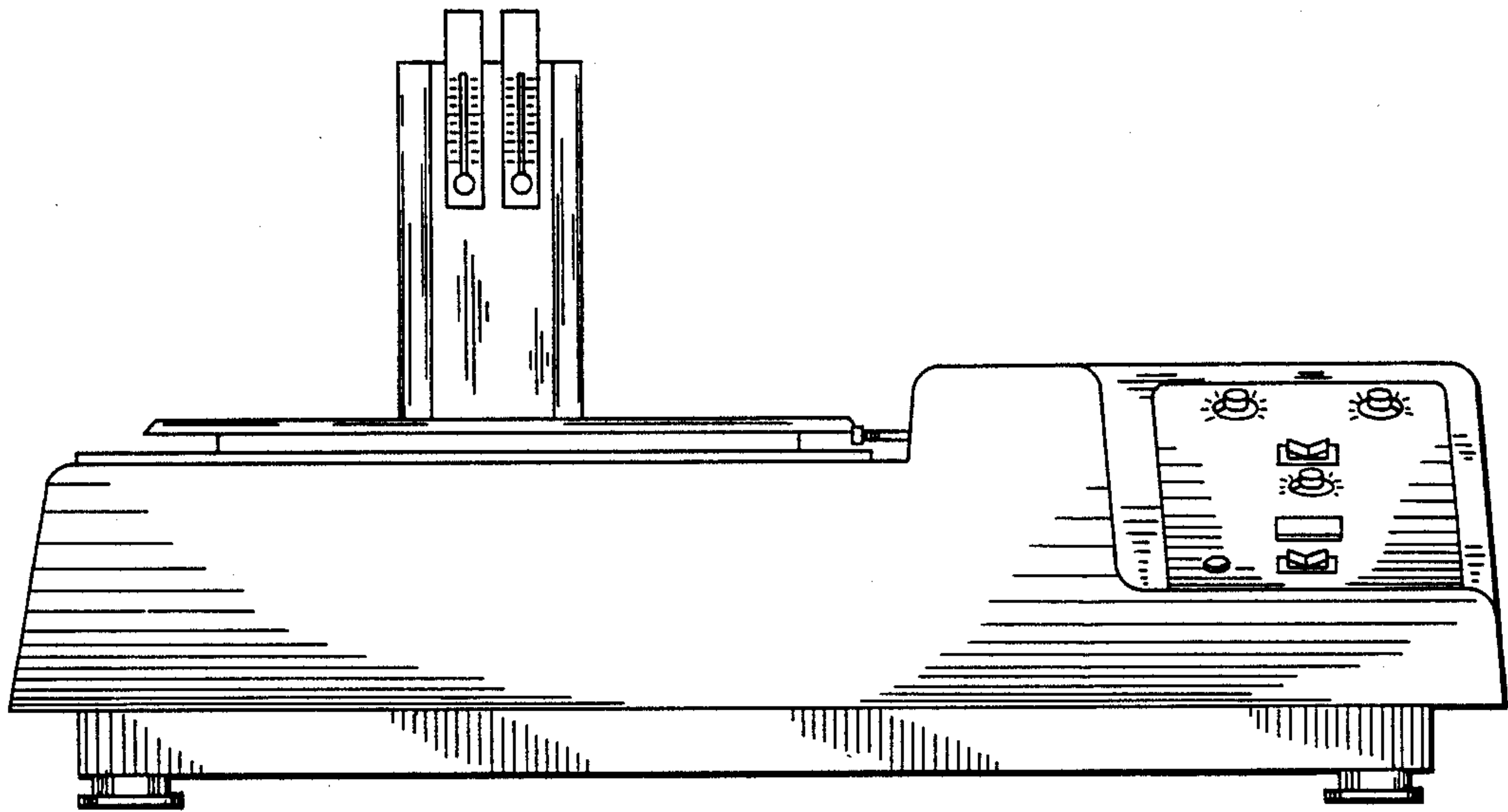

FIG. 1

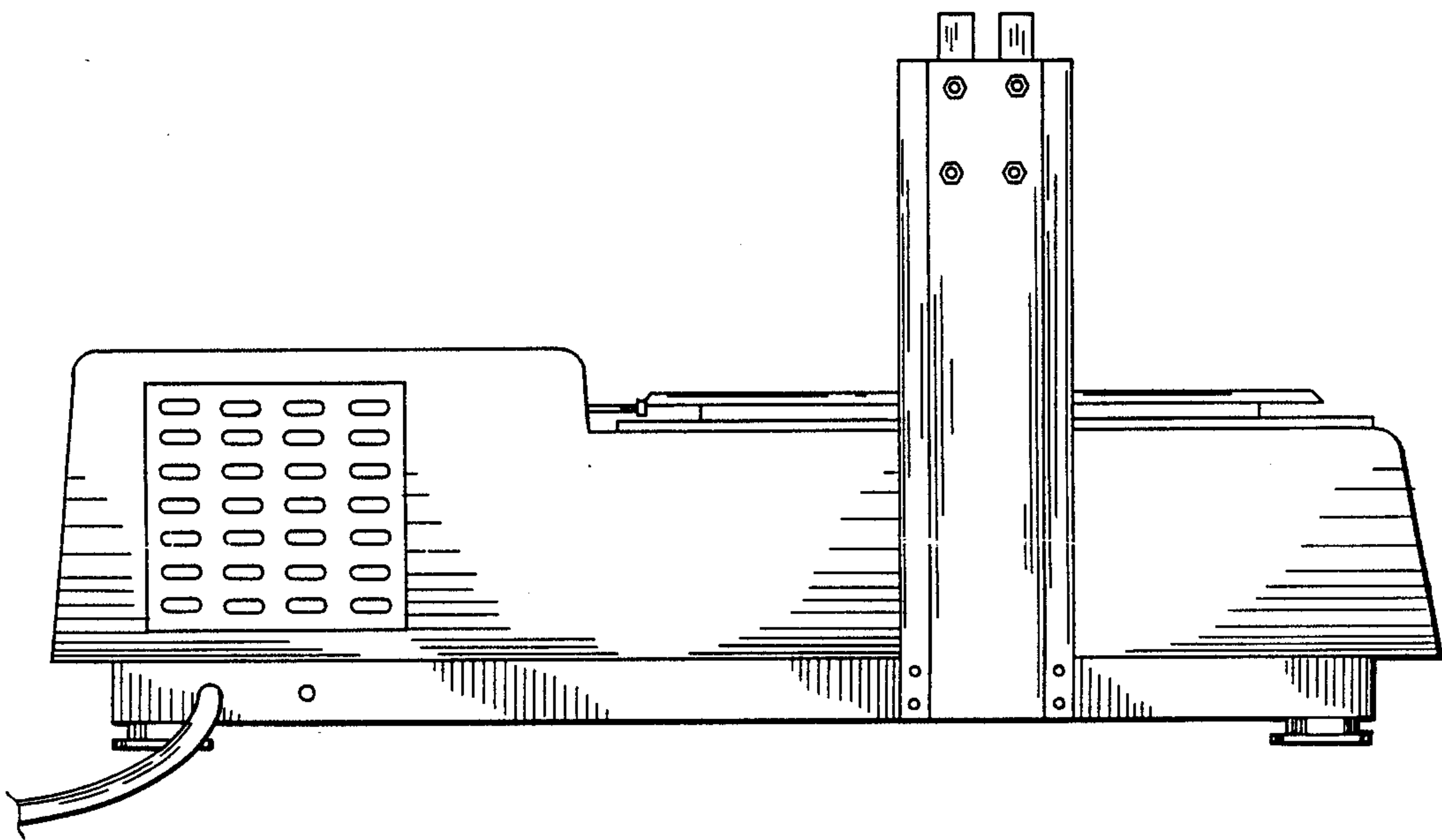

FIG. 2

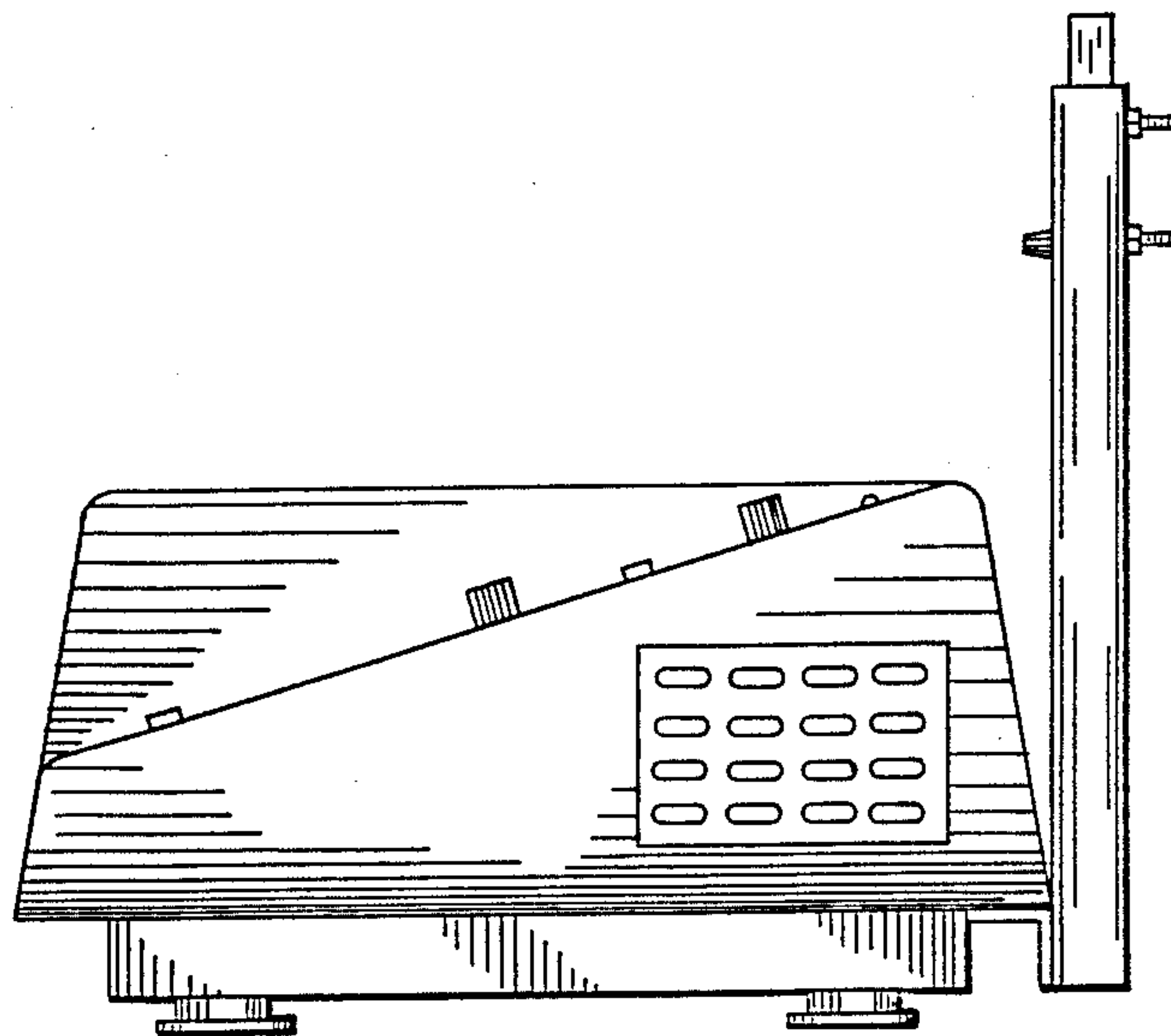

FIG. 3

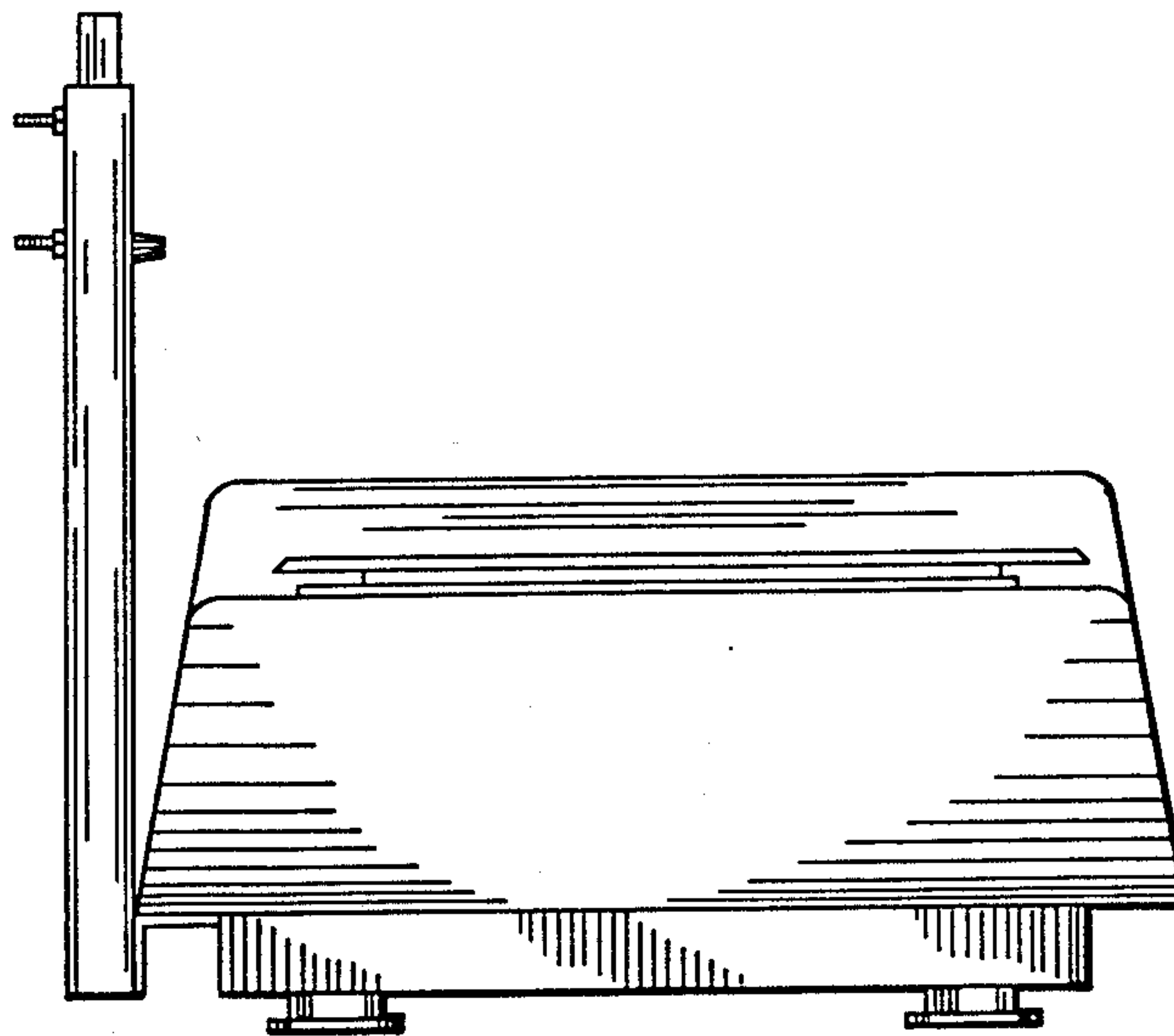

FIG. 4

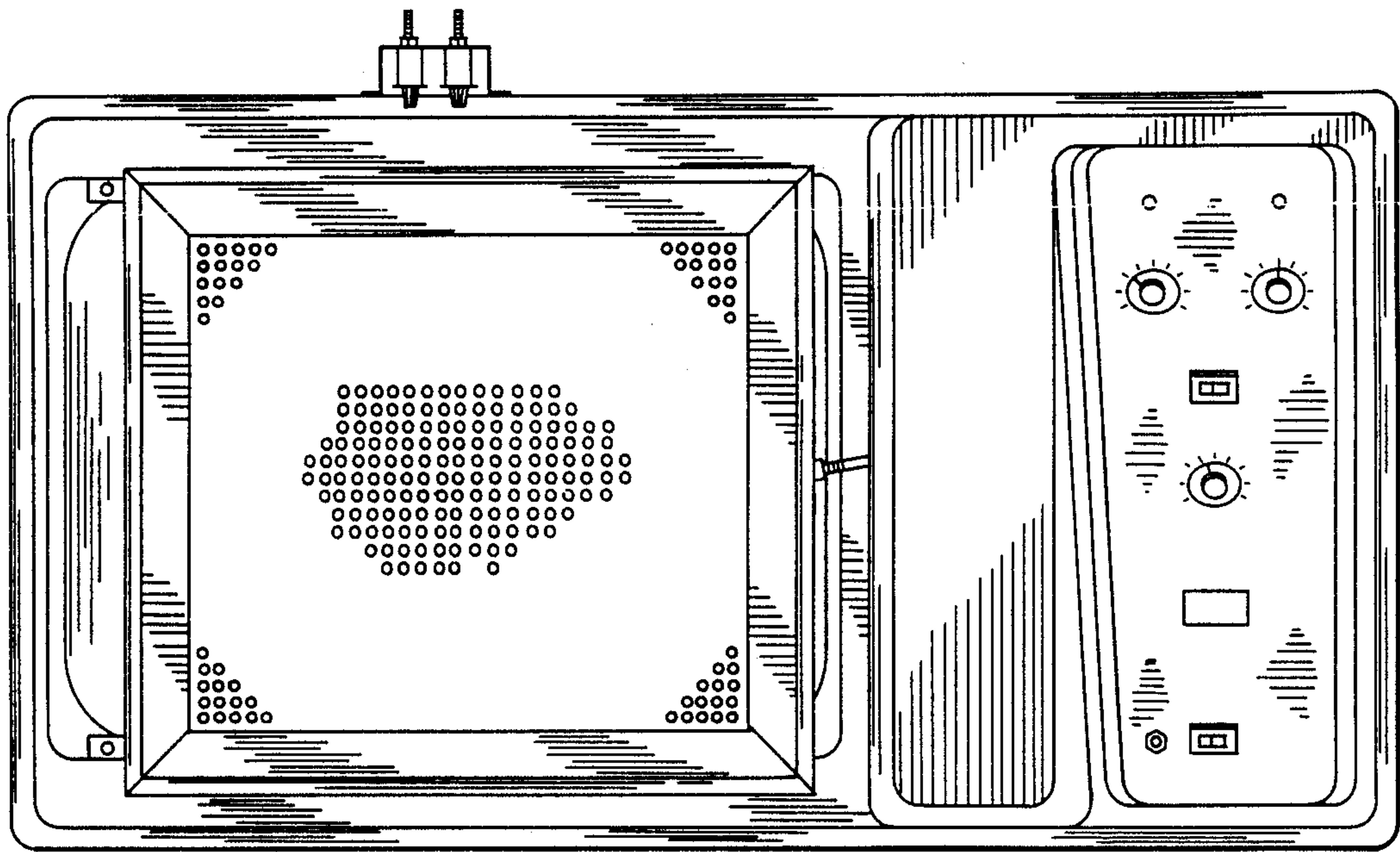

FIG. 5

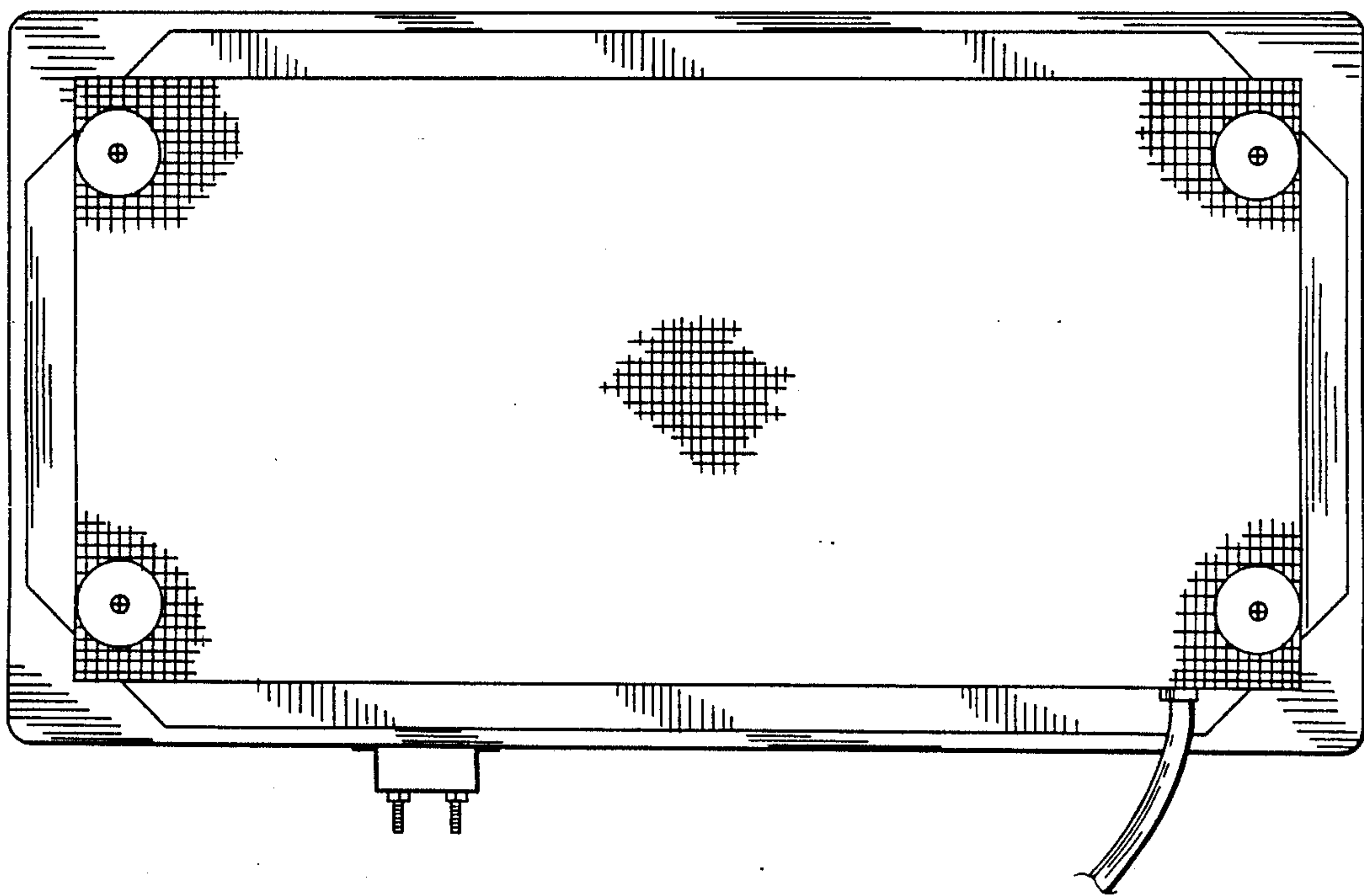

FIG. 6